

Olena Fialko¹

WEAPONS OF LONG DISTANCE COMBAT IN THE ARSENAL OF SCYTHIAN FEMALE WARRIORS

ABSTRACT

Fialko O. 2022. Weapons of long distance combat in the arsenal of Scythian female warriors. *Sprawozdania Archeologiczne* 74/2, 75-91.

Archaeological finds, supported by data from the literary tradition, indicate that women were presented among the Scythian army. 303 burials of Amazons have been recorded on the territory of European Scythia. A characteristic feature of their burials is the mandatory presence of weapons in the accompaniment sets. In the graves of the Amazons there are almost all types of attack weapons, dominated by the items of long-distance combat. The weapons of the female warriors completely corresponded to those in the arsenal of the Scythian army.

Keywords: female warriors, Amazons, weapons of long-distance combat, European Scythia
Received: 23.12.2021; Revised: 13.04.2022; Accepted: 21.12.2022

INTRODUCTION

Before discussing the armament of the Scythian female warriors, who we usually call the Amazons, I would like to note three points.

1. Legends about military women have been the subject of research for almost 3.5 centuries. Among the first works specifically devoted to the Amazons is a treatise by the French

¹ Institute of Archaeology, National Academy of Sciences of Ukraine, Volodymyra Ivasiuka Avenue 12, 04210 Kyiv, Ukraine; ofialka@ukr.net; ORCID: orcid.org/0000-0002-4976-3266

publicist Pierre Petit “Reflections on the Amazons”, published in 1685 in Latin and in 1718 in French translation. In it, the Amazons were seen as those who really existed (Petit 1718; Cosven 1947, 27).

2. One of the sources of information about the Amazons are the works of ancient authors – mythological legends and ethnographic information. The latter are especially interesting for us. For example, Pomponius Mela wrote in his “Geography” that the Amazons were engaged in the same activities as men and were not even exempted from military service. “Men serve in infantry and in battle throw arrows, and women engage in horse fighting and fight not with iron weapons, but “throw ropes at enemies and destroy them by dragging” (Mela I. 19. 114; here it is cited by: Latyshev 1949, 821). Hippocrates in his “On Airs, Waters and Places” says that the Amazons ride horses, shoot bows, and throw darts while sitting on horses (Hp. Aer. 24; here is cited by: Latyshev 1947, 295). Herodotus in his book “Histories” provides similar information when describing Sauromatic women. The historian noted that these women went hunting on horseback with or without men, went for fighting campaigns and wore the same clothes as men (Hdt. IV. 116; here it is cited by: Herodotus 1993, 206).

Therefore, according to ancient Greek authors, *the weapons* of the Amazons were bows with arrows, axes, darts, spears and small light shields in the shape of a crescent.

3. Very similar information is brought to us by the works of ancient masters. Today, about 1300 images of Amazons are known in the battle scenes alone (Worrall 2014), not counting domestic episodes. These characters were depicted in fact everywhere – from the friezes of temples (reliefs and statues), sarcophagi and funerary urns, ceremonial painted utensils to small jewelry and coins. And the images of these characters correspond are fully to the literary sources.

So, after getting a certain idea of how the ancient Greeks saw the Amazons, and most importantly their weapons, we should look at the archaeological realities.

THE DATA SET AND ITS QUALITY

In the territory of European Scythia, nowadays I am aware of 303 burials of Scythian female warriors from 267 kurgans, excavated in 116 burial mounds (Fig. 1). More than half (55%) of these graves were not robbed. According to the modern administrative division, these are the territories of seven regions of Ukraine (Mykolayiv, Dnipropetrovsk, Zaporizhzhia, Kherson, Odessa, Kirovohrad, Kharkiv, Cherkasy regions and the Autonomous Republic of Crimea), several districts of Moldova and some parts of Russia (Belgorod, Voronezh and Rostov regions). According to the territorial principle, burial complexes are divided into five main groups: 1. Lower Dnipro steppe (or Steppe); 2. Crimea Foothills; 3. Danube-Dniester steppes (or Transnistria); 4. Forest Steppe Dnipro area (or Forest Steppe); 5. Don region (Steppe and partly Forest Steppe). In some necropolises, the

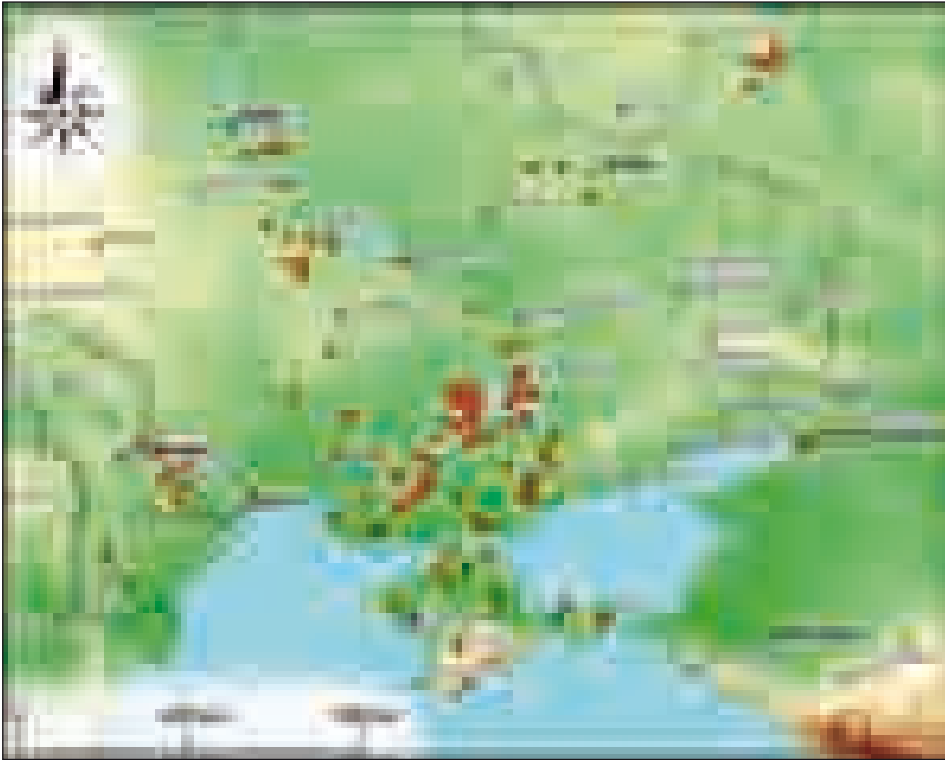

Fig. 1. The graves of Scythian women warriors on the territory of European Scythia

number of Amazons graves fluctuates from one – two up to 27 (Elizavetovsky burial mound) and 35 (burial mound near the village of Hlyne), respectively in Don region and Transnistria.

A characteristic feature of such burials is *the mandatory presence of weapons* (as opposed to jewelry) in the material accompaniment of the deceased. Among the 293 inventory sets available for consideration, the so-called male group, in addition to horse ammunition and cauldrons, is represented by the weapons found in each female warrior's grave (Fig. 2).

At first glance, the range of weapons used by women is somewhat limited. However, in the graves of the Amazons there are almost all types of offensive weapons with a predominance of the items for remote combat – arrows (95% of graves) and bows (1.4%), spears (23%) and darts (9%).

Starting the review of the weapons of the Scythian female warriors, I would like to note the number of weapons in one burial complex (Fig. 3). *One type of weapon* (mostly arrows or a spear, sling stones, occasionally a dart, an ax or a mace) is found in 65% of burials, *two*

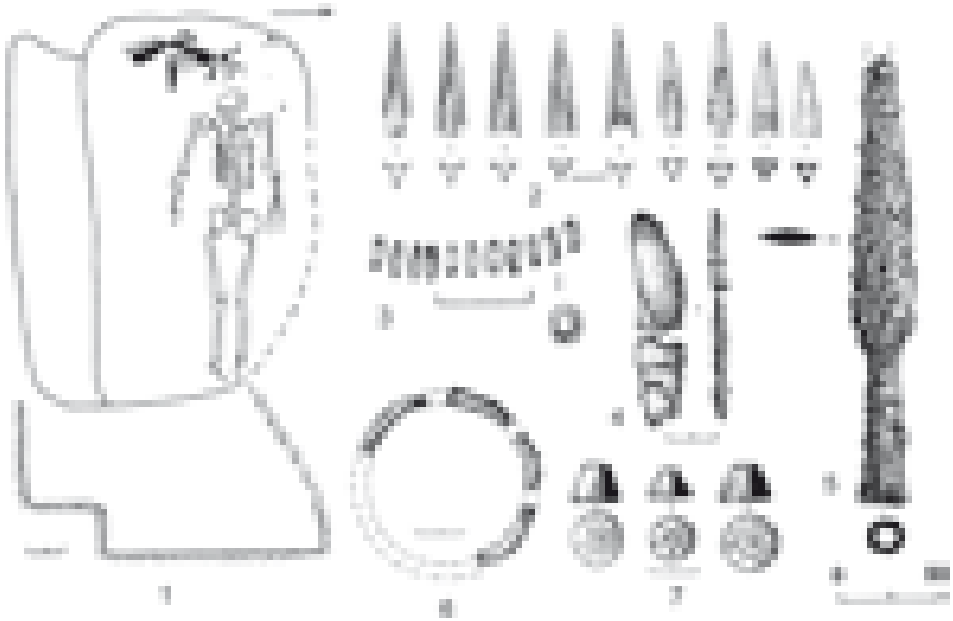

Fig. 2. The burial 3 of kurgan 54 in Mamai-Hora burial mound:
1 – plan and section of the grave; 2-7 – the set of burial implements

types (mostly arrows and a spear or a dart, rarely arrows and sling stones or sword) in 24,2% of burials, *three types* (arrows, either a spear and a sword or a dart or sling stones) in 10.5%, *four types of weapons* (arrows, a spear, a sword and sling stones) were found in only one burial (kurgan 37 of Elizavetovskiy mound), which represents 0.3% of the total number of graves.

Bows and arrows were the most popular types of small arms of female warriors. However, the degree of preservation of the two components of such a set is very different. Therefore, the remains of *wooden bows* were noted only in four graves: in one from the Steppe group (Nikopol, kurgan 20, burial 2) and in three graves from the Crimean group (village Volodymyrivka, kurgan 1, burial 4; village Frunze burial 1; village Ogonki – group of Tribatni kurgans – kurgan 2, burial 3) – respectively for a child, an adolescent and two women. However, I would like to remind that even in male graves bows are seen quite rarely. Bows are usually divided into simple (which are made of a simple solid bar) and complex or multiple components ones (made of several bars and overlays) (Lukyashko 2015, 36). The Scythians used both types of bows (Melyukova 1964, 15). This situation is also relevant for Amazons. In the child's burial (in Nikopol) the fragments did not allow to establish the shape of the bow. In the female grave (near Frunze village), based on the remains, the bow was simple; in the case of a woman from the paired tomb n.3 (village Ogonki) there was a complex segmental bow – 64.5 cm long (Fig. 4: 1); and in the grave of

Number of burials	% of weapons in a set	Number of graves	%
1		156	64.5
2		69	28.2
3		56	22.8
4		1	0.2
Total number of graves		282	100

Fig. 3. The number of weapons in the individual burials of the warriors

a teenage girl (Volodymyrivka village) – a complex sigmoid bow 55 cm long (Fig. 4: 2). In the last two cases, the bows had a spiral winding, made respectively of bark and leather. Probably, different types of bows are due to different conditions of combat – simple were used in infantry, and complex – from a horse.

There was one arrow with a bow in the child's grave, in the other three cases the bow was combined with a quiver with arrows (5, 32 and 52 specimens, respectively).

In this context, it is worth mentioning the relatively rare finds – *quivers*. These are narrow elongated cases made of wood and leather, which were usually placed near the hand (sometimes behind the head) of the deceased woman. In one case (Glynoe village, kurgan 104, burial 1) it is a product made of birch bark 55 cm long (Fig. 5). Remains of quivers have been found in 43 graves (20 in the Steppe Group, four in Crimea, nine in Transnistria, six in the Forest-Steppe and four in Don region). In two of them (group of Tribiratni kurgans, kurgan 2, grave 3; village Zhuravka kurgan 406, burial 1) the presence of a quiver is evidenced by the findings of characteristic clasps. Such cases were decorated in various ways, for example, a leather quiver (measuring 45 x 13 cm) from the burial 3,

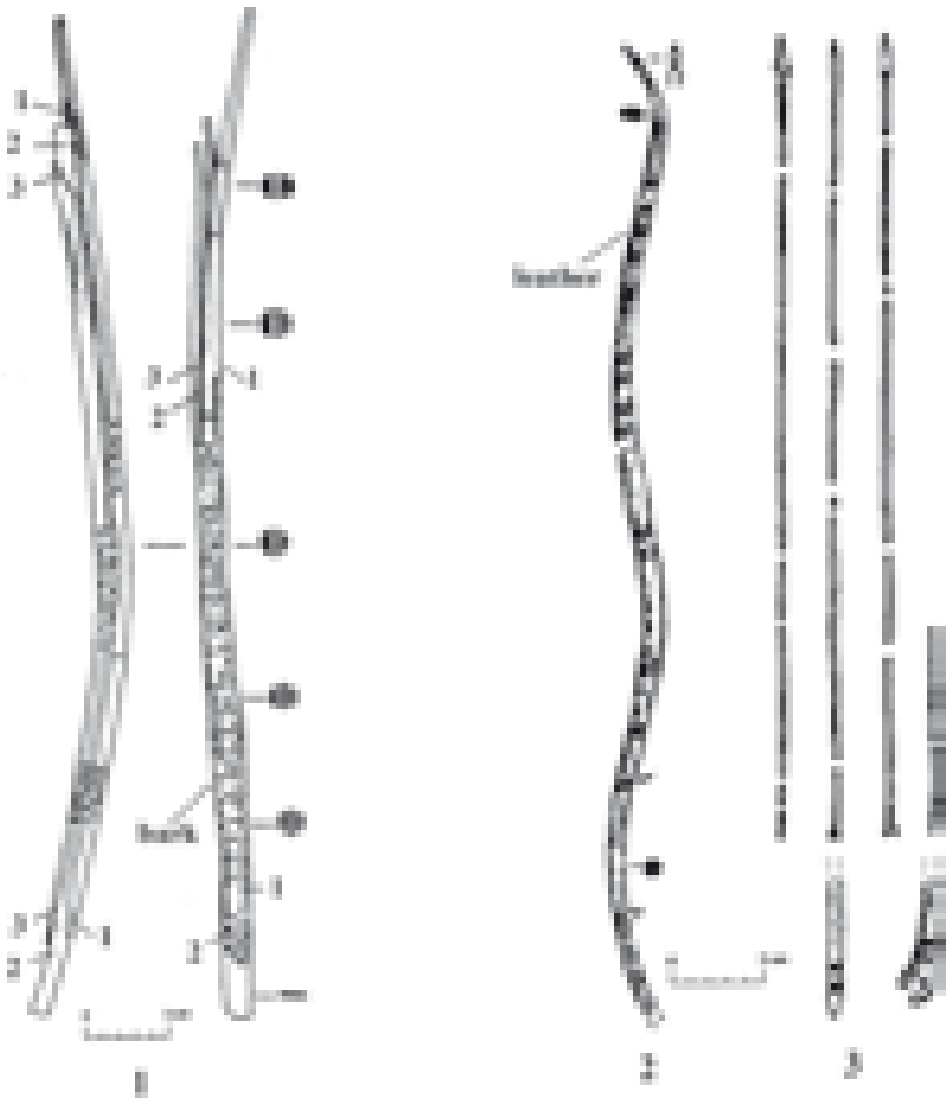

Fig. 4. The remains of wooden bows: 1 – village Ogonki (group of Tribatni kurgans) kurgan 2, burial 3; 2-3 – village Volodymyrivka, kurgan 1, burial 4 (bow and wooden arrows)

kurgan 10 near the village of Velyka Znamianka had a fur lining. The quiver from the burial 3, kurgan 38 near the village Lubimivka was preserved better than the other ones. It was a leather-covered wooden frame measuring 62×15 cm, the lower part of which was decorated with thin electrum plates. The utensils of this quiver, in addition to 135 arrows with bronze points, included an iron knife with a bone handle. Often a special compart-

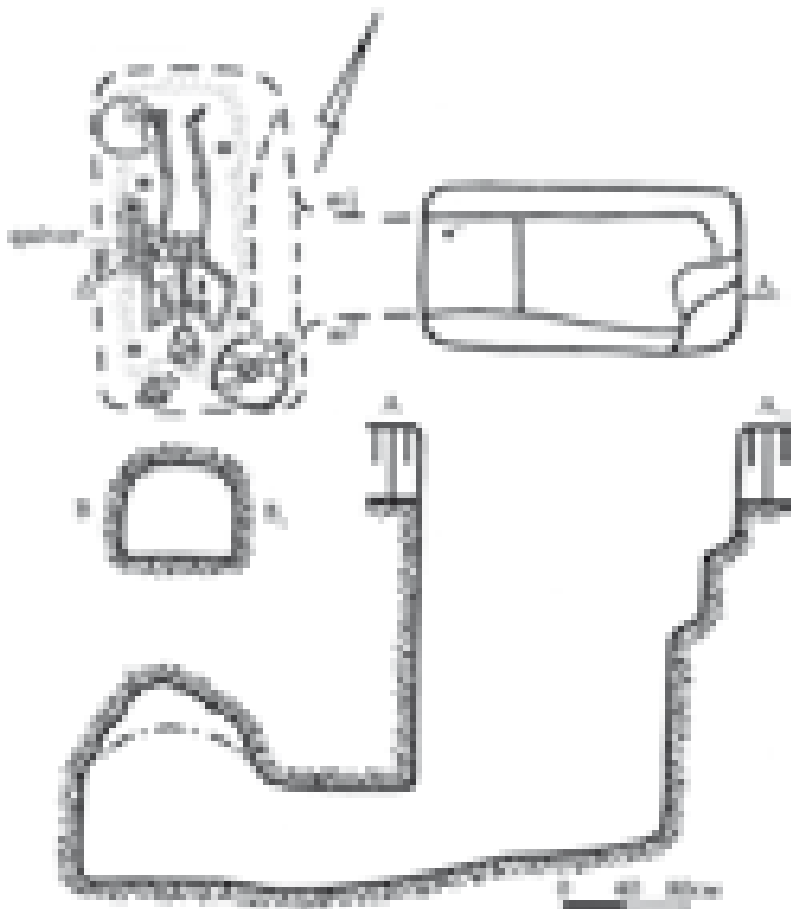

Fig. 5. The birch bark quiver from burial 1 of kurgan 104 near village Glynoe
(by: Telnov *et al.* 2016, fig. 347: 3)

ment – a pocket – was arranged for a knife in a quiver (Chernenko 1981, 43). In the necropolis near the village Glynoe (Transnistrian group) quivers are related to iron quiver awls, which are found in six female sets (Fialko 2017). No such connection has been observed in other Amazon complexes.

Arrows are represented by quiver sets, in bundles and by single specimens. They are present in 268 (95%) female burial complexes of all regional groups. Only the points remained, the shaft and their plumage were not recorded. Only in three cases in the Steppe group (Velyka Znamyanka village, kurgan 10, burial 3) and in Crimea (Volodymyrivka village, kurgan 1 burial 4; Ogonki village, kurgan 2, tomb 3) the wooden poles (up to 40-45 cm long) with colored markings were preserved (Fig. 4: 3). In the first two cases, the ends of

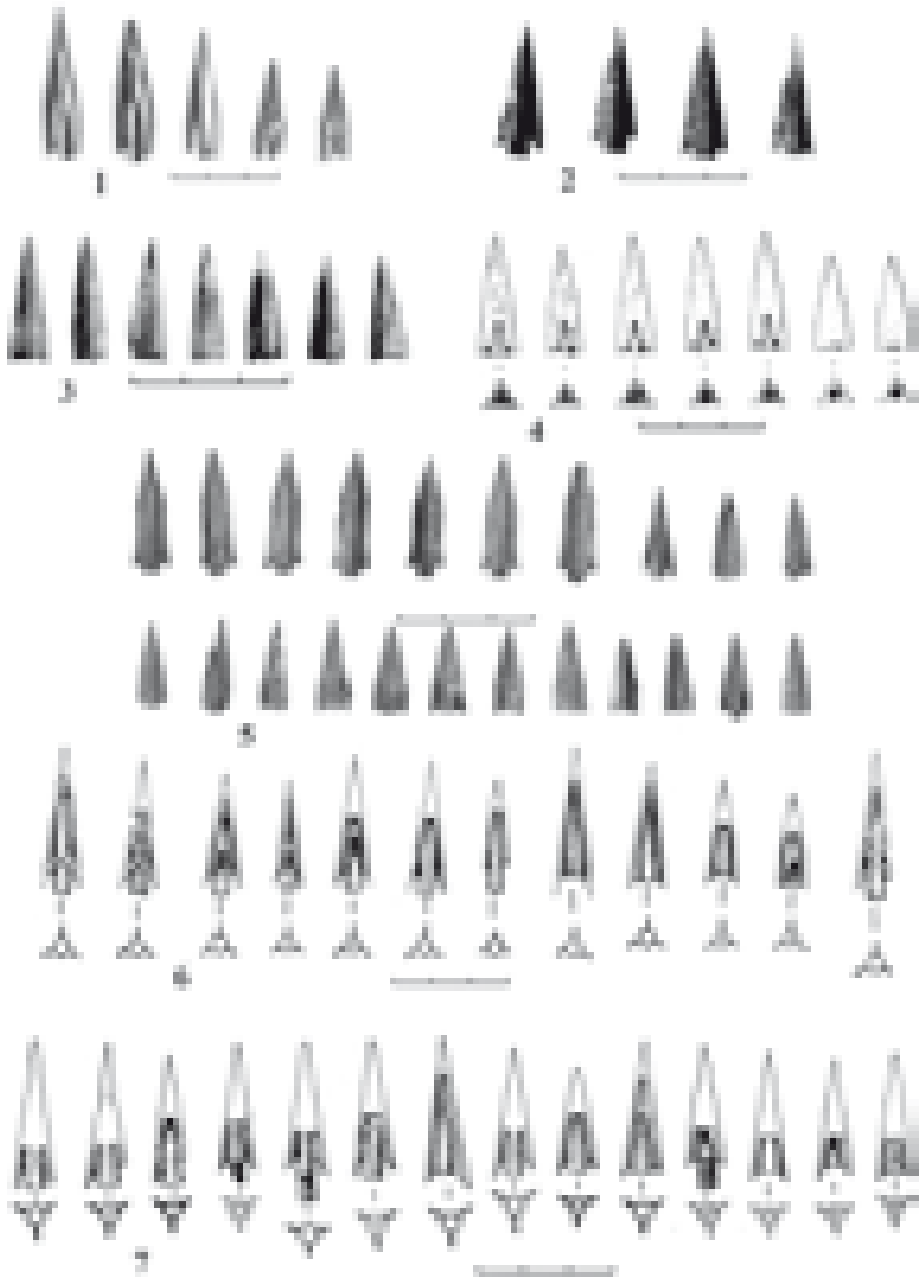

Fig. 6. The sets of arrows with bronze tips: 1 – burial 2, kurgan 6 near the village Maryivka; 2 – burial 2, kurgan 16 near the village Novopylypivka; 3 – burial 36 near the village Skelki; 4 – burial 1, kurgan V near the urban settlement Velykyi Rohachyk; 5 – burial 1, kurgan 5 near the village Shelyugi; 6 – burial 1, kurgan 1 near Horodyshe city; 7 – burial 1, kurgan 14 near the village Nikolske. Photo by O. Fialko

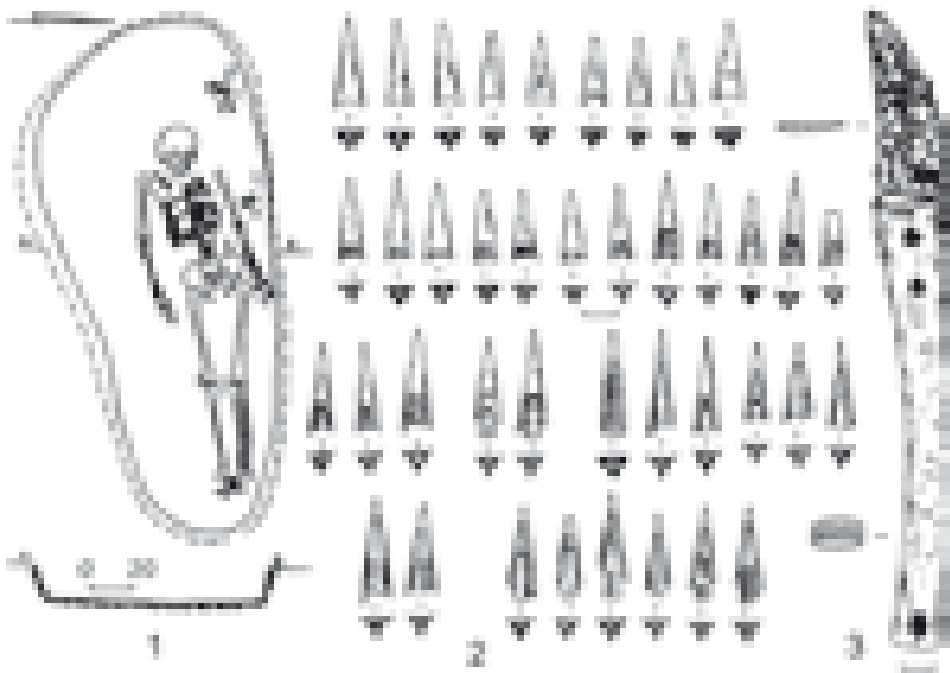

Fig. 7. The burial 44 from a burial ground near Skelki village: 1 – plan and section of the grave; 2-3 – the set of burial implements. After Popandopulo 2011, fig. 26

the poles had red and black belt-marks, in the latter – the same, but also in white and yellow colors. Sometimes short parts of the shafts remained in the socket near the arrowhead. It is possible that in some cases the arrow shafts were intentionally broken for ritual purposes.

The Scythians used arrows with tips made of bronze, iron, bone and wood. Generally, Amazons sets included arrows with *bronze* trihedral and trilobate tips (Fig. 6), typical for the sights of late 5th – early 3rd century B.C. (Melyukova 1964, 25-29). Quantitatively, trihedral points predominate (Fig. 6: 3, 4). Norms of the “ammunition” for arrows did not exist. This situation is observed for all Scythian quiver sets, regardless of the sex and social level of their owner (Hrytsiuk, 2009, 63). In the Amazons accompaniment sets different amounts of arrows were found: from a few units or several dozen to hundreds or more arrows (Fig. 7). The largest number was recorded, for example, in the burial 1, kurgan 45 near the village Lyubimivka – 98 specimens, in the burial 3, kurgan 2 near the village Zelene – 107 specimens, in the burial 2, kurgan 12 near Nosaky tract – 119 specimens, in the burial 1, kurgan 406 near the village of Zhuravka – 129 specimens, burial 1, kurgan 8 near Nove village – 130 specimens. The maximum number of arrows (135 specimens) was found in the burial 3, kurgan 38 near the village of Lyubimivka (Steppe group) and (150

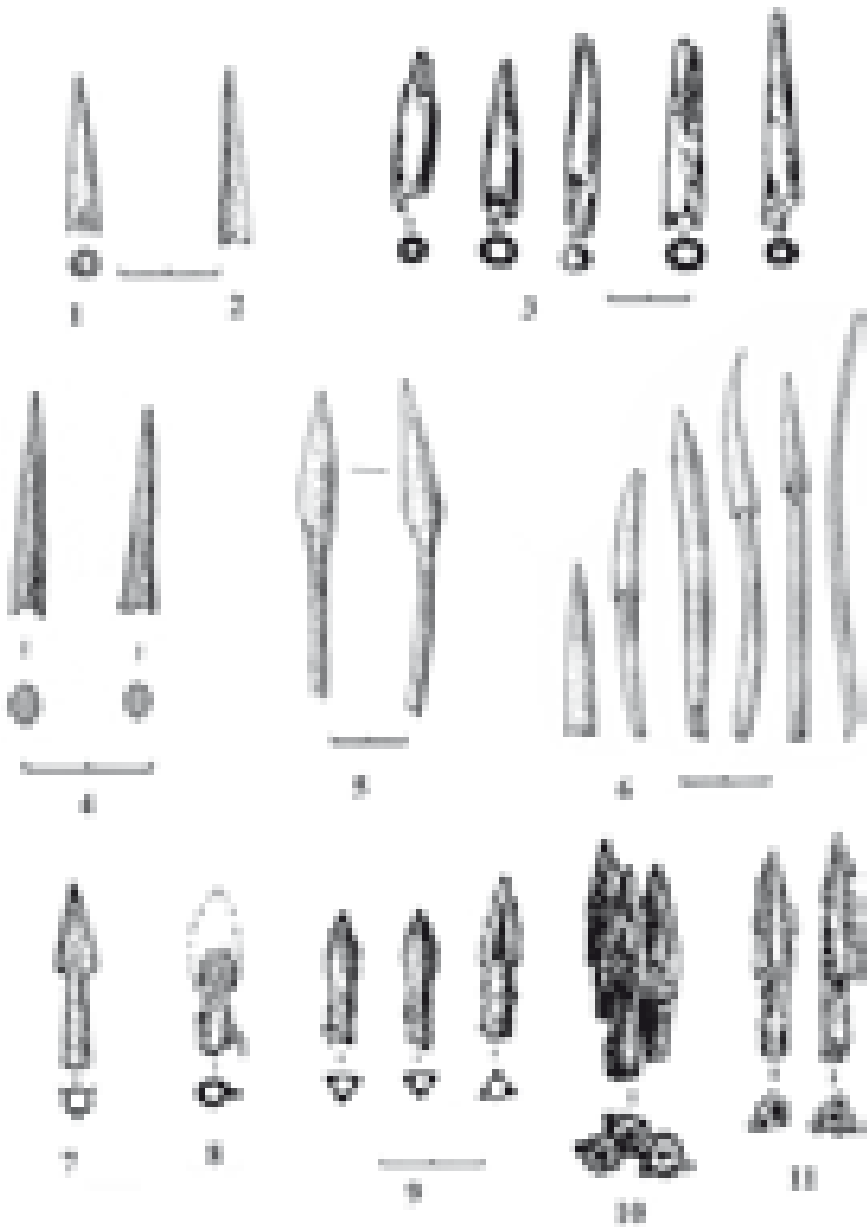

Fig. 8. The arrowheads made of other materials. Bone arrowheads: 1 – burial 1, kurgan 2 near Shiroke village; 2 – burial 2, kurgan 5 near Lvove village; 3 – burial 2, kurgan 1 near Volodymyrivka village; Wooden arrows: 4 – burial 1, kurgan 21 near Gyunivka village; 5 – burial 2, kurgan 13 of the BOF group; 6 – burial 3, kurgan 10 near Velyka Znamyanka village; Arrows with iron tips: 7 – burial 1, kurgan 2 near Shiroke village; 8 – burial 2, kurgan 1 near Kamkaly village; 9 – burial 50 near the village Skelki; 10 – burial 1, kurgan 12 near Glynoe village; 11 – burial 2, kurgan 12 near Glynoe village

specimens) in the burial 2, kurgan 6 near the village of Balabany (Transnistria) (Fialko 1987; 2011).

There are much fewer arrowheads made of other materials. *Bone arrowheads* (Fig. 8: 1-3) are recorded in sets, mostly with bronze once, in only 11 burials of all regional groups (in the Steppe in five graves, in Crimea in two, in Transnistria in two, and one grave in the Forest-Steppe and Don region each). There were from one to 18 items in one set. And in only one burial of the Crimean group (the village of Volodymyrivka, kurgan 1, burial 2), the set consisted of only five arrows with bone points. It is believed that bone points were intended for hunting.

Extremely rare are *wooden arrows* (Fig. 8: 4-6), recorded in nine burials of only two regional groups (five – in the Steppe and two – in Crimea) in combination with bronze tips arrows. And in only one burial (the village of Volodymyrivka, kurgan 1, burial 4) the set consisted of five wooden arrows. In the quiver from the burial 1, kurgan 5 near the village Nove, along with 82 bronze tips there were two wooden ones – round in cross section with small, pinned spikes (4.4 cm long). In a set of 24 bronze tips in the burial 2, of the kurgan 6 of the same burial mound, one wooden specimen was preserved. It was similar to the one described above, but slightly shorter (3.7 cm). Two integral arrows with two-bladed heads of rhombic shape come from the set of burial 2 of kurgan 13 of the BOF group (named after Bogdanovsk concentration plant). The length of their tip is about 5 cm, the total length is 8.5 and 9 cm. Such arrows are little known due to the poor preservation of wood.

Arrows with iron tips give a slightly different picture. These are usually three-bladed specimens with a long cylindrical socket (Fig. 8: 7-11). And usually, the sets here consisted of the same type of iron arrowheads. In the Steppe and Forest-Steppe groups they are found in rare complexes (six and two, respectively), in the Crimea they do not exist at all, and in Don and Transnistria regions they are much better represented. For example, in the Steppe group, three iron arrowheads were found in the burial 2 of kurgan 8 near the village of Ternivka; two specimens (together with five bronze ones) – in the burial 2 of kurgan 40 in Mamai-Hora burial mound; one specimen (among 16 bronze ones) is in the burial 6 of kurgan 10 in the Chortomyk mound. In the Forest-Steppe – one iron tip (among 62 bronze ones) was found in the burial 2, kurgan 9 near the village Staryi Merchyk. The last one, which is the best preserved, is a three-bladed tip with a long cylindrical socket. Often the iron tips belong to an earlier time than the bronze arrows in the set. It is possible that such an archaic arrowhead was used here as a certain amulet.

In Don region such arrows are noted in 16 graves (out of 27), in eight exclusively with iron arrowheads, from one to 35 items, up to 84 in one of the cases (village Kolbino, kurgan 5, burial 1). Rates are even higher in Transnistria – here iron arrowheads are noted in 31 burials (out of 50), and in 18 of them arrows are exclusively with iron points. Moreover, all these graves were discovered in one necropolis near the village Glynoe. I should also note a few points regarding the sets of arrows from the last necropolis. Firstly, the dominance of iron arrowheads of the same type (in general, a tenfold increase in this burial

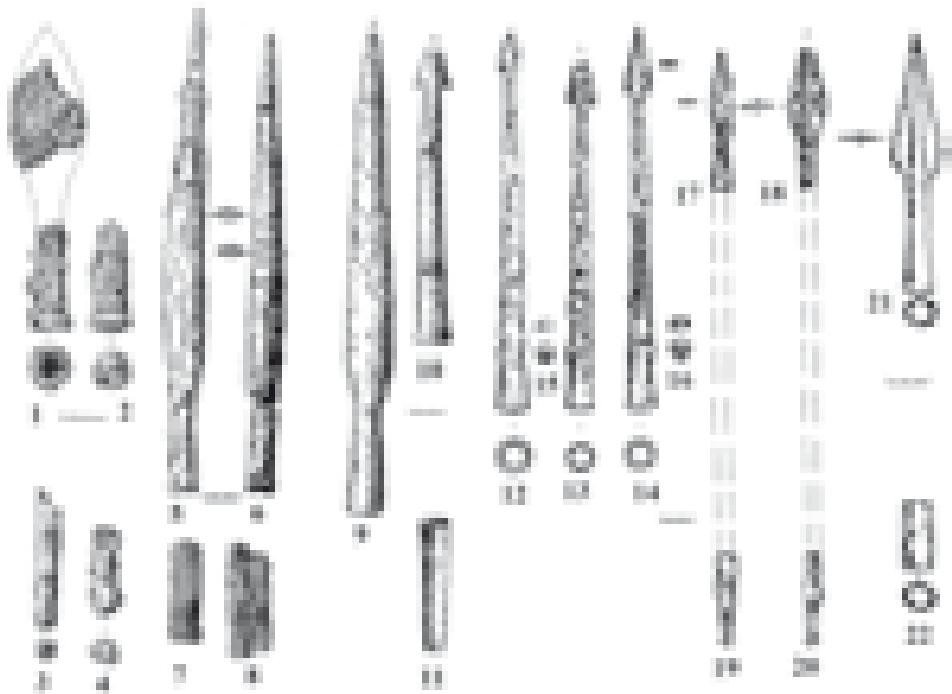

Fig. 9. Spears and darts from the graves of Scythian Amazons: 1-4 – burial 1, kurgan 10 near Velyka Znamyanka village; 5-8 – burial 2, kurgan 16 near the village Novopylypivka; 9-11 – burial 1, kurgan 1 near the village Kapulivka; 12-20 – - burial 1, kurgan 1 near the village Stebliv; 21-22 – the Dort-Oba kurgan

mound) (Telnov *et al.* 2016, 772). Secondly, such a small number of arrows in one set is surprising – from one to 11. Only in five graves this figure is slightly exceeded (in the kurgan 24 – 18 items, in the kurgan 103 – 19, in the kurgan 3 – 24, in the kurgan 45 – 28, in the kurgan 104 – 33 items). However, the number of arrows could be due to a certain social status of the deceased woman (Fialko 2015, 77). Thirdly, in the four female graves of this necropolis (kurgan 32; kurgan 38; kurgan 66 and kurgan 69), the arrows are clearly associated with injuries, as they are fixed in all cases in the chest area of the deceased. Besides no other weapons were found there. The interpretation of individual arrow finds could be quite ambiguous (Fialko 2019).

Regarding the arrows with iron tips, we can assume that their presence in the sights of two groups (in Don region and in Lower Dnipro territories) reflects the emergence of reinforced protective armor in the arms of the enemy.

The second position among the popular weapons belongs to **spears and darts**, with a quantitative predominance of the spears (3 to 1). Short spears with iron tips and end spikes or spear butt (weight fitted onto spear-shaft for balance) (Fig. 9: 1-9), with round in



Fig. 10. The burial 1 of kurgan 13 near the village Kapulivka:
1 – the plan of the grave; 2-17 – the set of burial implements

section wooden shafts were used. The latter are rarely preserved in graves, mostly in fragments. At the same time, very often in robbed complexes the presence of a spear or a dart is evidenced by the cylindric caps (ends of the spears) left or lost by robbers (Fig. 9: 3-4; 7-8; 11). It is possible to determine the length of a spear or a dart due to the location of the tip and the end spike, found in situ in the grave. For example, the full length of the spear from the burial 1, kurgan 5 near the village Nove was 2.07 m (Fialko 1987, 174). Almost the

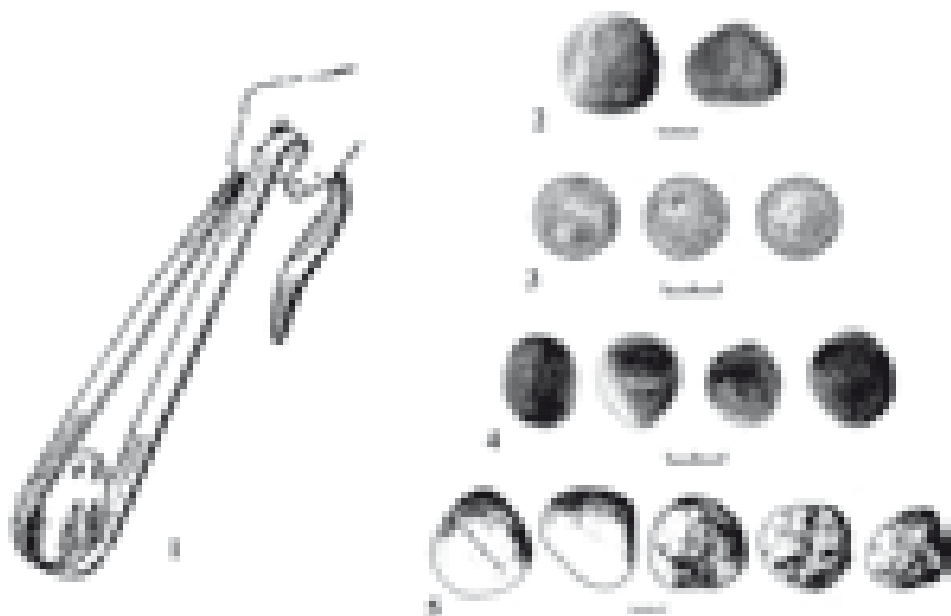

Fig. 11. The principle of slings functioning (1) and stone bullets from the graves of Scythian female warriors: 2 – burial 1, kurgan V near the urban settlement Velykyi Rohachyk; 3 – burial 3, kurgan 5 near the village Zelene; 4 – burial 12, kurgan 1 near the village Novomykolayivka; 5 – burial 7, kurgan 1 near the village Nove. Photo by O. Fialko

same length (2.1 m) were two spears from the burial of the kurgan 13 from the Stebliv burial mound (Skoryi 1997, 89). This fully corresponds to the size of ordinary Scythian spears and darts (Melyukova 1964, 43; Chernenko 1991, 133). Only one spear from the Dort-Oba kurgan (from Crimea) had a bronze tip (Fig. 9: 21), the rest had iron tips and butts. Most iron tips have sharp-leaved shape. They differ in the length of the socket, the edge of which is usually covered by a coupling (Fig. 9: 1-2). Spearheads were recorded in 83 (28%) Amazons burial complexes (including those where both, a spear and a dart were in the set). The cylindric ends by themselves (one or two) were found in 21 graves. According to the regional groups, the number of burials with spears is as follows: Steppe – 40, Crimea – 4, Transnistria – 5, Forest-Steppe – 7, Don region – 12. So almost every third female deceased was buried with a spear. The number of spears in one burial is one or two (in approximately equal proportions). In only two cases the woman had three spears (burial 2 of kurgan 6 near the village of Nove; burial 1, kurgan 22 near the village of Zolota Balka).

Darts – short spears with elongated tips of a stinger shape, were specially designed for throwing (Fig. 9: 10, 12-14). Quantitatively, they were much inferior to spears. This tendency is also characteristic for the Scythian weapons in general (Hrytsiuk 2009, 66). Darts

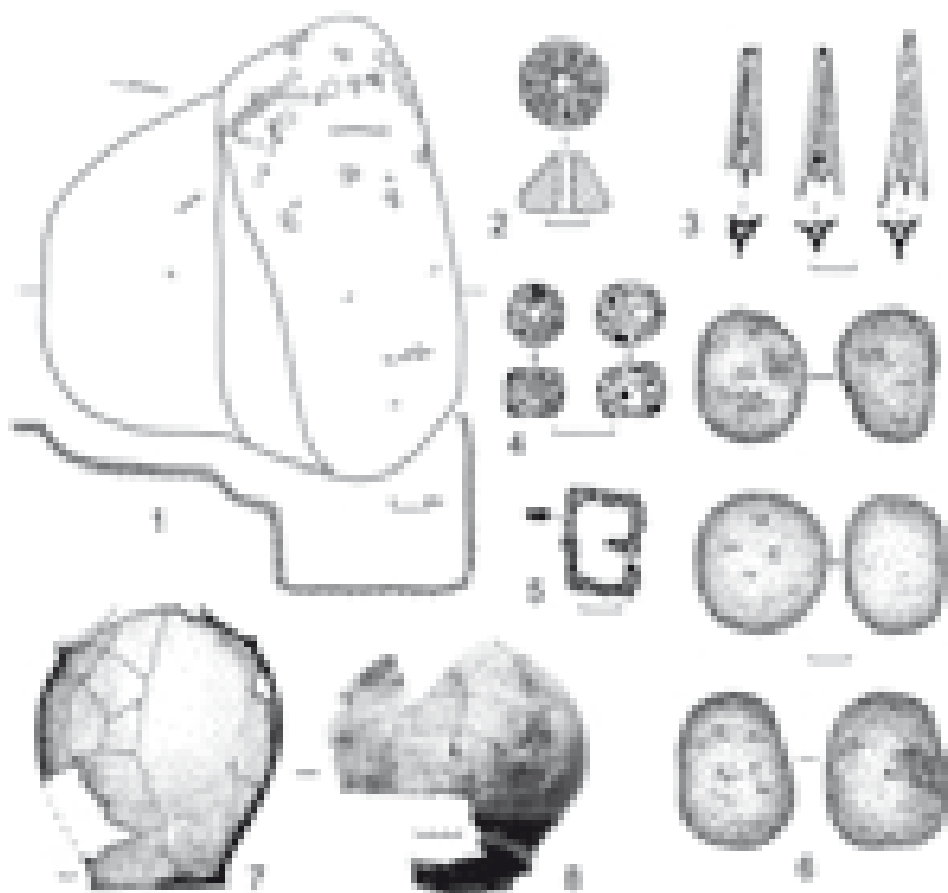

Fig. 12. The burial 14 from a burial ground near Skelki village:

1 – plan and section of the grave; 2-8 – the set of burial implements. After Popandopulo 2011, fig. 11

are noted only in 27 (9%) graves of Amazons. They were usually placed one by one in the grave. Exceptions are the burial 2 of kurgan 11 near the village Llove, burial 1 of kurgan 15 near the village Zolota Balka and burial 1 of kurgan 16 near the village Durovka (two darts found in each burial) and kurgan 13 of the Stebliv burial mound, where three darts were found in a set with spears (Fig. 9: 12-20). Only in one burial there were three darts (burial 1 from kurgan 3 near the village of Dudchany). In almost half of the cases, the darts were paired with a spear (Fig. 10). The wooden handles of most spears and darts at the lower end had a cylindrical or conical end (Fig. 9: 11). However, this part of the weapon was optional. The design features as well as tactical and technical characteristics, submitted to the functional purpose of the weapon, indicate that the Amazons preferred metal spears and darts.

The tips of spears and darts were often kept in leather or cloth covers, tightened with a lace with a vorvorka (sort of a clasp, that usually looks like a pendant button). The remains of such a cover with a bone vorvorka-button are recorded, for example, in the burial 1, kurgan 5 near the village Nove; two iron vorvorkas on dart sockets – in the burial 1, kurgan 13 near the village Stebliv (Fig. 9: 15-16).

The Amazons also used a sling (or a slingshot), another type of projectile weapon designed for long-range combat. The principle of its functioning is that the soldier twisted the sling and, by releasing one of the belts, sent a stone bullet towards the enemy (Fig. 11: 1). The sling-bullets exclusively are kept in the burials (Fig. 11: 2-5). Only in one (burial 7, kurgan 11 near the village Lvove) there were the remains of a leather belt, which could correspond to a sling stone. “Bullets” of more or less round shape were made of different types of stone and differed in size. Scythian sights are known for such stones ranging in size from a walnut to a chicken egg, or even an apple (Melyukova 1964, 68). In women’s burials such stones were rather small – 5-6 cm in diameter. Stones were found in 31 (10%) burial complexes of the Amazons (13 in the Steppe, 3 in Transnistria, 9 in the Forest-Steppe, 6 in Don region, in Crimea they are absent). There were usually one to five stones in the set (Fig. 12). And only in one case (burial 1, kurgan 1 in Elizavetovsky burial mound) was a set of 17 stones. However, the separation of the slings from the general mass of stone finds is somewhat complicated, as they are similar to those that served as heating elements. Slingshots were used by both infantry and cavalry. The unpopularity of this type of weapon in the female environment may be due to its great weight.

The earliest graves of the Amazons date from the second half of the 7th – beginning of the 6th centuries B.C. Thus, burial complexes of the Scythian Amazons both in the territories of the nomadic dwellings at the beginning of the Iron Age, and in the areas controlled by the Scythians (or border areas), date from a wide range – from the second half of the 7th to the 2nd centuries B.C. However, the main group of these tombs is dated 4th century B.C.

CONCLUSIONS

The represented review of the weapon allowed to draw the following conclusions:

1. Scythian Amazons were armed with projectile weapons – first of all, bows and arrows, relatively short spears and darts, and slingshots.
2. Weapons of hand-to-hand combat (*i.e.* stabbing and slashing types of weapon) – swords and daggers, battle axes, polearms were used much less by women.
3. Bow, that was the most popular type of weapon for the Amazons, was used both on foot and on horseback. Shooting a rider in motion on a moving target required remarkable skills. Long-term training was necessary to achieve a long-distance targeting of the enemy, as well as the accuracy of shooting (Chernenko 1981, 115; Hrytsiuk 2009, 64).

4. In general, the weapons of the female warriors fully corresponded to those in the arsenal of the Scythian army. However, the Amazons clearly preferred weapons intended for contactless combat.

References

- Chernenko E. V. 1981. *Skifskiyе luchniki*. Kiyev: Naukova dumka.
- Chernenko Ye. V. 1991. Lytsari Velykoi Skifii. In P. P. Tolochko (ed.), *Zoloto Stepu. Arkheolohiya Ukrayiny*. Kyiv, Shlezviih: Instytut arkheolohii NANU, Arkheolohichniy zemelnyi muzei Univer-sytetu Kristiana Albrekhta, 131-135.
- Fialko E. E. 1987. Skifskie kurgany u s. Novoye. In O. G. Shaposhnikova (ed.), *Drevneyshie skotovody stepey yuga Ukrayiny*. Kiev: Naukova dumka, 171-187.
- Fialko E. E. 2011. Panopliya skifskikh voitelnits. *Tyragetia s.n.*, 5/20, 1, 265-278.
- Fialko E. E. 2015. Amazonki vo vremeni i prostranstve. *Arkheolohiya i davnia istoriya Ukrayiny* 4(17), 46-99.
- Fialko E. E. 2017. Seriya pogrebeniy skifskikh voitelnits v mogilnike u s. Glinoe (Moldova). *Arkheologiya i davnia istoriya Ukrayiny* 2(23), 208-227.
- Fialko O. Ye. 2019. Zbroya v pokhovanniakh skifskiykh zhinok: mistse ta pryznachennia. In V. P. Chabai P. (ed.), *I Vsheukrainskyi arkheolohichniy zizd: materialy roboty*. Kiev: Instytut arkheolohii NANU Ukrayiny, 393-405.
- Herodotus. 1993. *Istorii v deviaty knykhakh*. A. O. Biletskyi (ed., tran.). Kyiv: Naukova dumka.
- Hrytsiuk V. M. 2009. *Viysko skifiv (ozbroennia, orkhanizatsiya viiny ta voenne)*. Kyiv, Chernivtsi: «Misto».
- Kosven M. O. 1947. Amazonki. Istoriya legendy. *Sovetskaya etnografiya* 3, 3-32.
- Latyshev V. V. 1947. Izvestiya drevnikh pisateley o Skifii i Kavkaze. *Vestnik drevney istorii* 2, 294-298.
- Latyshev V. V. 1949. Izvestiya drevnikh pisateley o Skifii i Kavkaze. *Vestnik drevney istorii* 1, 816-832.
- Lukiashko S. I. 2015. Strelkovoє vooruzheniye skifov. O vremeni poyavleniya sigmovidnogo luka v Vostochnoy Evrope. *Vesti Volgogradskogo gosudarstvennogo universiteta*. Seriya 4. Istoriya 5 (35), 36-45.
- Melyukova A. I. 1964. *Vooruzhenie skifov (= Svod Arkheologicheskikh Istochnikov D1-4)*. Moskva: Naukova Dumka.
- Petit P. 1718. *Traité historique sur les amazons, traduction du latin*. Leyde: Marchand.
- Popandopulo Z. H. 2011. *Scythian soil burial ground "Scelki"*. Zaporizhzhya: Poligraph plus.
- Skoryi S. A. 1997. *Steblev: skifskiy mogilnik v Porosye*. Kiev: Instytut arkheolohii NANU.
- Telnov N. P., Chetverikov I. A. and Sinika V. S. 2016. *Skifskiy mogilnik III-II vv. do n.e. u s. Glinoe*. Tiraspol: Stratum plus.
- Worrall S. 2014. Amazon Warriors Did Indeed Fight and Die Like Men. *National Geographic*, 29.10.2014.

