

MATERIALS AND DISCOVERIES

FASCICULI ARCHAEOLOGIAE HISTORICAE XXXIV: 2021
ISSN 0860-0007, e-ISSN: 2719-7069
DOI 10.23858/FAH34.2021.007

JAROSŁAW OŚCIŁOWSKI*

CROSSBOW PART FINDS FROM THE TERRITORY OF MAZOVIA AND DOBRZYŃ LAND

Abstract: The article discusses crossbow finds from the territory of historical Mazovia and Dobrzyń Land. These finds are mainly pieces of spanning devices and triggers. In the latter category we have a lever from the stronghold (motte) in Lekarce Nowe as well as a few bone and antler nuts from strongholds in Czersk, Pułtusk, Warsaw, and Wizna. Included among the parts of spanning devices there is a mechanism from the castle in Liw. Furthermore, spanning stirrups have been recovered from strongholds on the Vistula river in Bobrowniki and Dobrzyń. The find from Liw merits special attention. This spanning device is of the band-and-belt type, which rarely occurs in East-Central Europe. Furthermore, the bow of the stirrup from Dobrzyń is provided with a broad foot plate with an asymmetrical rib. Such a construction was of significance for spanning the crossbow. The artefacts from Mazovia and Dobrzyń Land are dated from the 2nd half of the 13th to the 15th century.

Keywords: Mazovia, Middle Ages, crossbow, draw hook, stirrup, nut, lever, stock's facing

Received: 16.04.2020 **Revised:** 04.05.2020 **Accepted:** 18.04.2021

Citation: Ościłowski J. 2021. *Crossbow Part Finds from the Territory of Mazovia and Dobrzyń Land*. "Fasciculi Archaeologiae Historicae" 34, 93-105, DOI 10.23858/FAH34.2021.007

INTRODUCTION: A CROSSBOW FROM MAZOVIA AND DOBRZYŃ LAND IN WRITTEN AND ICONOGRAPHIC SOURCES

The origins of the use of crossbows in Mazovia and Dobrzyń Land are not known from medieval written sources. There are also no medieval iconographic sources from this area depicting crossbows. The Chronicle of Wincenty Kadłubek (early 13th century) describes troops of crossbowmen (*balistis*) in the Mazovian army of Miećław. The description concerns events in the 1040s and it is not possible that the information about crossbowmen could be authentic.¹

There is some information from 1373 about Siemowit III, Duke of Mazovia selling the post of mayor of the city of Bielsk to a nobleman named Andrzej. This arrangement obligated the new mayor to send one

crossbowman to help the duke and his descendants in time of war.² In the first phase of the Great War against the Teutonic Order (1409-1411) the Mazovian duke Janusz I let the judge of Ciechanów Land command the army of 150 crossbowmen. They were supposed to defend Ciechanów.³ Some crossbow-makers from Old Warsaw were also mentioned in written sources from 1440s, e.g. Bartosz *balistifex* (1449) and Marcin called *szamostrzelnyk* or *balistrator* (a few years later). Another crossbow-maker named Marcin had a workshop at Świętojańska street.⁴ Another workshop at Freta street, including equipment and living quarters cost 40 'three score' groschen in half-groschen.⁵ Unfortunately, no facts are known about weapon manufacturers from the Dobrzyń Land area.⁶

* Institute of Archaeology and Ethnology Polish Academy of Sciences, Warsaw;  <https://orcid.org/0000-0001-5743-9311>; osciłowski@iaepan.edu.pl

¹ *Vincentii Kadłubek*, II, 14, see Polish translation: *Wincenty Kadłubek*, II, 14. Cf. Szymczak 2017, 220.

² NKDM 2000, no 286, 306-307.

³ Pacuski 2016, 57.

⁴ Szymczak 1990, 276-277.

⁵ Koczorowska-Pielińska 1983, 63 and annexes.

⁶ Szymczak 1995, 64.





Fig. 1. Area of Mazovia and Dobrzyń Land. Drawn by J. Ościłowski.

CROSSBOW PARTS FROM MAZOVIA AND DOBRZYŃ LAND

The parts of the crossbows discovered in Mazovia and Dobrzyń Land (Fig. 1) are as follows: the parts of hooks to draw a crossbow string from the village of Liw, stirrups from Bobrowniki and Dobrzyń nad Wisłą, trigger's elements: the nuts from Wizna, Pułtusk, Czersk, and Warsaw (3 specimens); a trigger lever from Lekarzycie Nowe, and two ornamented bolt rests from a crossbow stock found in Pułtusk (Fig. 2).⁷

The parts of a hook to draw a crossbow string The draw hooks

The parts of a hook for pulling a crossbow string represent one object found in Mazovia, from the castle in Liw. The hook is dated to the 13th-15th century.⁸ It

⁷ This article was written during the course of the author's preparation of a dissertation titled 'Medieval weaponry from the Mazovian area.'

⁸ It was found during excavations conducted by T. Wróblewski in 1977. Collection of the Regional Museum (Muzeum Regionalne) in Siedlce (MS, cat. no A/00110, Acc. no MRS/A/83). The basis for the conclusion about the dating of the artefact is unknown. This information was included in the museum card from 2014 (author: J. Myrcha).

is made of two bow-shaped ingots, which look like a spur or big buckle. At the ends of the arms there is a riveted iron roller connecting both parts. In the middle of the artefact there is a rectangular plate (ingot). It is in its upper part rolled up on the roller, which is riveted to the arms. The rivets are big and their heads are conical. Two hooks extend from the upper part of the bow. The artefact is 9 cm long and 5.5 cm wide (Fig. 3:a-d). The find represents a roll-belt type of draw. It is an improved version of a roll-cord type of draw.⁹ It was made of short small iron ladder with two hooks to catch the cord and roll. Under the roll there was a leather double belt. The belt, on which the roll moved when the bow was drawn, had iron fittings with holes in its upper part, which helped regulate the belt's length. To draw the crossbow, a shooter turned the crossbow nut sideways (with the lock facing the shooter) and put the crossbow on the ground. Bending down, the shooter slipped the belt fittings over the hook on the stock's back and slipped cord on the hooks of the ladder. Holding the ladder with his fingers, he bent back and by standing upright drew a cord to a nut

⁹ Egon Harmuth has reconstructed this artefact, Harmuth 1986, 158-159, Fig. 101:2.

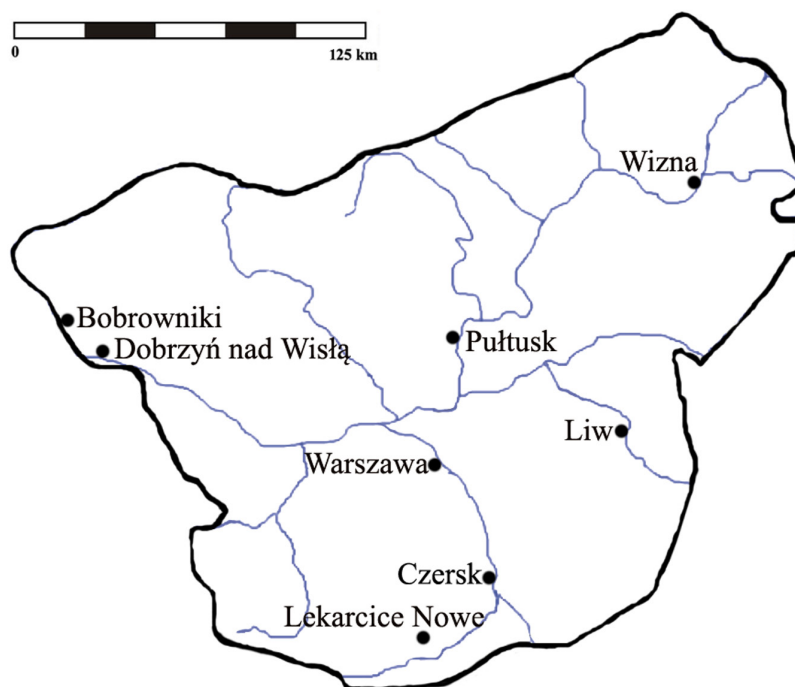

Fig. 2. Finds of crossbow elements from Mazovia and Dobrzyń Land. Drawn by J. Ościłowski.

using the power of his leg muscles¹⁰ (Figs. 4 and 5). This kind of drawing is known from the miniature placed in the *Feuerwerkbuch* from the Royal Armouries Museum in Leeds, c. 1440 (Fig. 6), from a 15th century play card with a picture of a shooter (Kunsthistorischesmuseum in Vienna), and also from the lost painting *The Siege of Malbork in 1460* (painting dated before 1488)¹¹ (Fig. 7). Artefacts with a similar structure come from what is now the Czech Republic: from Mstěnice settlement (dated to before 1468) and Skály castle (dated to before 1440).¹² According to the mentioned analogies I assume the found artefact's chronology should be narrowed to the 15th century.

The stirrups

Two stirrups are known to have been found on defensive sites in Dobrzyń Land. The first was found on the territory of the stronghold in Dobrzyń nad Wisłą.¹³

This stirrup dates to before 1409.¹⁴ It is round in shape and tapers in the upper part. The height of the stirrup is 11.6 cm, and the width in the lower part is 13.6 cm. The arms of the bow have a diameter of 0.9 cm. The short ridge has two wings (0.1-0.3 cm wide) that extend upwards. They are situated asymmetrically in respect to each other. They are 4.1 cm wide. The foot is 3.5 cm wide and 0.2 cm thick. The bow on the back is flat and the foot is wide and flat, containing a ridge (0.7-0.8 cm wide and high) (Fig. 8). The last one is situated asymmetrically (1.6 cm from one side vs. 1.1 cm from the other side of the foot),¹⁵ which probably had a function in the drawing process. This type of stirrup is characteristic for the 15th-16th century according to the typology of stirrups based on iconographic sources.¹⁶ A similar stirrup (also with a ridge) can be seen on the one-foot crossbow at the Pszczyna Castle Museum (Muzeum Zamkowe w Pszczynie). Therefore, the stirrups from Dobrzyń nad Wisłą can be dated to the first half of the 15th century.¹⁷

¹⁰ Harmuth 1986, 158-159, Fig. 101:2; Richter 2006, 112-113; Kruczek 2013, 64, Fig. 65.

¹¹ Kruczek 2013, 64, Fig. 66.

¹² Brych 2012, 34, Fig. 10:a.

¹³ The stirrup was found during the excavations conducted by J. Grześkowiak and B. Wawrzykowska in 1971. The inventory card of the District Museum in Toruń (Muzeum Okręgowe w Toruniu) defines the artefact's chronology to the 14th-15th century. The artefact comes from Trench II from 1971 (layer 1, depth 10-30 cm). Layer 1, which was turf, had been formed in the process of erosion of layers from the northern part of the stronghold, Grześkowiak 1974, 214 and 216; Wawrzykowska and Grześkowiak 1978, 284.

¹⁴ On the chronology of this stronghold chronology, cf. Grześkowiak 1974, 211-234; Wawrzykowska and Grześkowiak 1978, 275-284; Andrzejewski and Horonziak 1997, 95-105.

¹⁵ The inventory card of the District Museum in Toruń (Muzeum Okręgowe w Toruniu). Kind information from R. Uziembło's (The District Museum in Toruń).

¹⁶ Type n according to Kruczek's typology, cf. Kruczek 2013, 51, Fig. 39.

¹⁷ Kruczek 2002, 13-15; Kruczek 2013, 60, Fig. 59.



Fig. 3. Crossbow draw from Liw. Collection of the Regional Museum in Siedlce. Photo by J. Ościłowski.

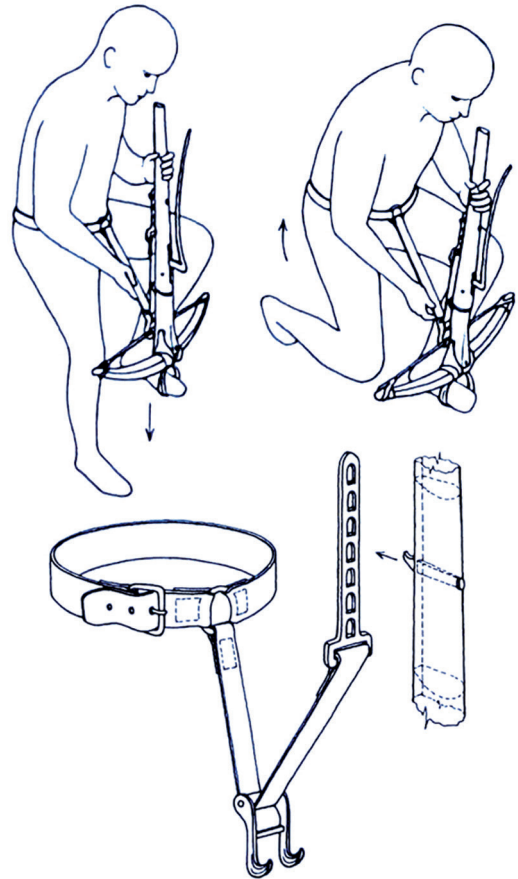

Fig. 4. A belt with a hook for pulling the string of a crossbow. After Pengl and Belcredi 2012, 42, Fig. 4.

Another crossbow, made of horn, contains a stirrup with a ridge and comes from Transylvania. It is dated back to the 15th century.¹⁸ Analogous stirrups are known from the Czech Republic, found in Havraň and Mstěnice. The find from Mstěnice is dated to the period before 1468.¹⁹ According to the aforementioned analogies and the date of the destruction of the stronghold in Dobrzyń (1409), the artefact from Dobrzyń should be dated to the beginning of the 15th century.

The stirrup from Bobrowniki contains a ridge, which is however rounder and slightly flattened from above. The stirrup is about 12 cm high and 16 cm wide. The bow is round in its section and about 0.8 cm in diameter. It broadens and makes a flat ridge, which is 6 cm long and 3 cm wide. The foot is 3 cm wide, including the bow's arms²⁰ (Fig. 9). Somewhat similar

in shape is an artefact found in a burnt-out motte in Plemięta. It dates to the period before 1414.²¹ The crossbow with stirrup of round shape is visible on *The Resurrection* from the polyptych on the Jesus' and Maria's Life from the chapel of the Teutonic Knights Castle in Grudziądz (dated to about 1390)²² and in Konrad Kyeser's treatise *Bellifortis* (c. 1405).²³ In medieval iconographic representations, round-shaped stirrups appear mainly between 1390 and 1400.²⁴ It can be assumed that the artefact from Bobrowniki can be dated to the end of the 14th century to the beginning of the 15th century.

The crossbow trigger elements The nuts

Six crossbow nuts were found in Mazovia (one each from Czersk, Pułtusk, Wizna; three from Warsaw),

¹⁸ Kruczek 2013, 61, Fig. 60. The author did not provide any sources of information or the basis for the chronology of the artefact.

¹⁹ Brych 2012, 30, Fig. 1:b, 34, Fig. 10:b.

²⁰ The dimensions according to Wojciechowski 1989, 490, Fig 5:1. The stirrup is in the collections of the Institute of Archaeology of the University of Lodz. No information about stratigraphy

and chronology of the find, see Horbacz 1983, 154-163; Horbacz 1985, 71-113; Horbacz 1995, 145-154.

²¹ Kola and Wilke 1985, 115, Table 13:3.

²² Kochanowska-Reiche 2003; Kruczek, 2013, 51, Fig. 41.

²³ Richter 2006, 3, Fig. 17; Kruczek 2013, 51, Fig. 40.

²⁴ Typed according to Kruczek's typology, cf. Kruczek 2013, 51, Fig. 39.

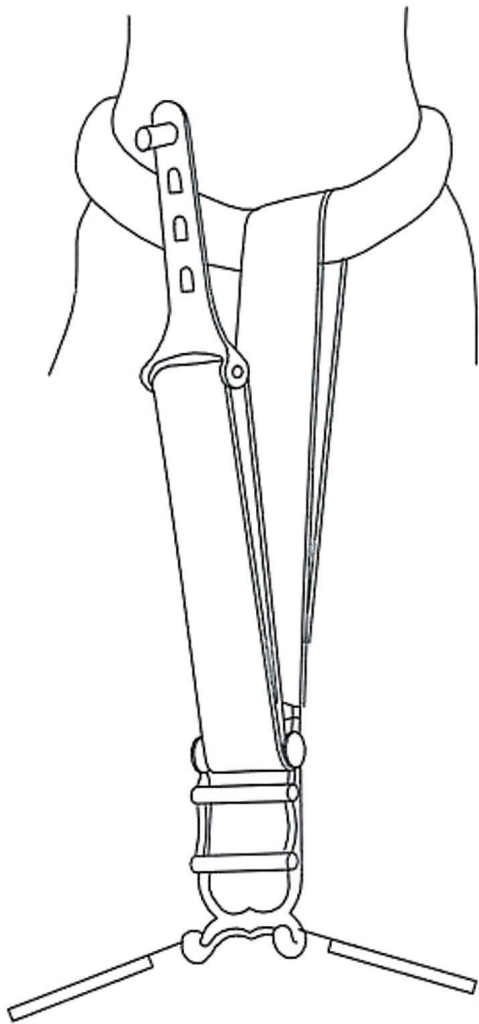

Fig. 5. A belt with a hook for pulling the string of a crossbow. After Hartmuth 1986, Fig. 101:2 with additions by Kruczek 2013, Fig. 65.

made of bones or antlers. The nut from Czersk (Fig. 10) is dated broadly from the turn of the 14th and 15th centuries to the 17th century, based on the stratigraphic configuration of the layers.²⁵ It has a hole for a pin. It is 3.1 cm in diameter, 2.1 cm thick. The axis hole is 0.5 cm in diameter.²⁶ The nut from Pułtusk is dated to the last quarter of the 13th century. It is made of red deer antler and has a metal pin and a groove for a lever. It is 0.1 cm wide outside and 0.3 mm thick inside. The roller is 3.6 cm in diameter and 2.3 cm

²⁵ According to J. Rauhut the nut was found in the votive pit (are 38, quarter A, layer 12, phase 14). The relic was earlier dated to the end of 13th century and the beginning of the 14th century, Rauhutowa 1988, 115. According to P. Urbańczyk this layer was laid down in order to level the ground after construction works at the castle wall, Urbańczyk 2016, 123-127.

²⁶ The dimensions are described based on the illustration (in probably a 1:1 scale) made by S. Nowińska, see Rauhutowa, 1988, 115, Fig. 8.

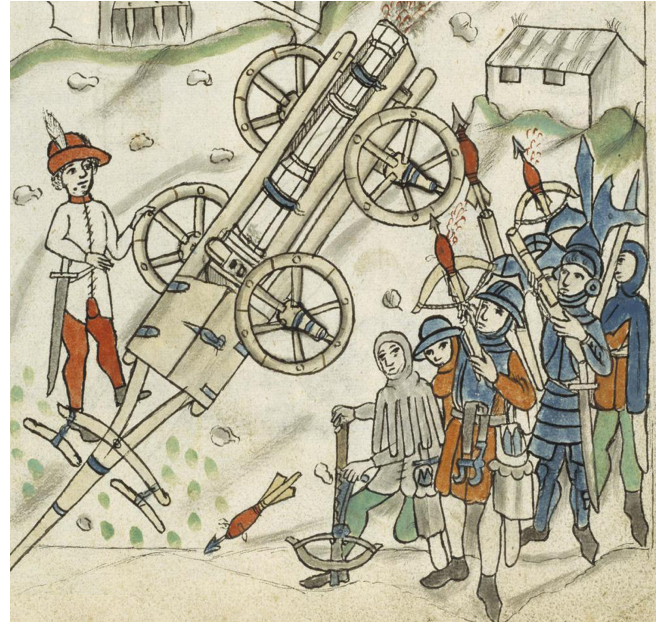

Fig. 6. *Feuerwerkbuch* from the Royal Armouries Leeds, dated to c. 1440, fol. 84r.



Fig. 7. *The Siege of Malbork in 1460*, painting dated to 1488. Based on microfilm in the Archives of the Archaeology and Ethnology Institute of the Polish Academy of Ethnology, Branch in Łódź.

thick, and the axis hole is 0.5 cm in diameter. The cut is 6 mm wide²⁷ (Fig. 11). The nut from the stronghold at Wizna is preserved in two parts. They are made of antler and have no pin, but only a groove for a lever. The roller is 3 cm in diameter and 1.6 cm thick, and

²⁷ The collections of the Regional Museum in Pułtusk. Wojciechowski 1989, 486-487, Tab 1. The information from D. Stabrowska (The Regional Museum in Pułtusk).



Fig. 8. Stirrup from Dobrzyń nad Wisłą. Collection of the District Museum in Toruń Photo J. Ościłowski.

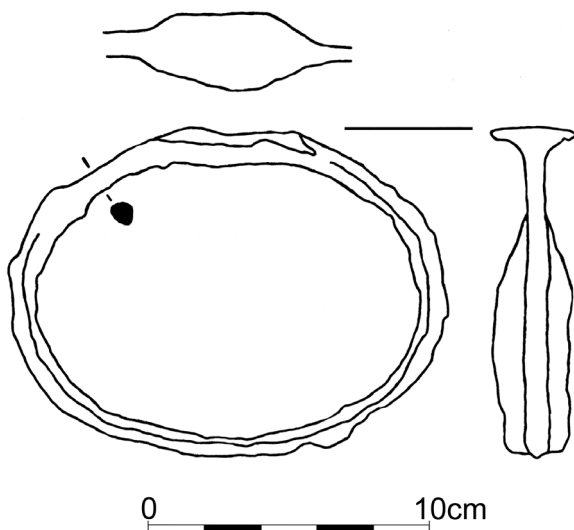

Fig. 9. Crossbow stirrup from Bobrowniki. After Wojciechowski 1989, Fig.5:1.

the axis hole is 0.3 cm in diameter. The nut is dated to the 14th-15th century (Fig. 12).²⁸ All three nuts from

²⁸ Jarzębska 1972, Table 12:2. The chronology according to Wojciechowski 1989, 486-487, Tab. 1. According to the inventory card of the Podlaskie Museum in Białystok the chronology of the

Warsaw were found on the terrain of the Castle Square (plac Zamkowy). The first find is part of the right-side surface. It is one-third of the whole nut and is shaped like a round broken shield with a hole in its middle part. This fragment is 4.08 cm in diameter and 1.27 cm thick. The hole is 0.61 cm in diameter (Fig. 13).²⁹

The second nut is preserved as part of the right-side surface, about one quarter of the whole nut. It is shaped like a round broken shield with a hole in its middle part. It has the whole arm for catching a cord. The nut is 3.4 cm in diameter. The hole is 0.43 cm in diameter. The preserved part is 0.8 cm thick (Fig. 14).³⁰

The third nut from Warsaw has preserved the whole right arm for drawing a cord, which is 1.44 cm high and 0.95 cm thick. The nut's roller is 3.55 cm in diameter. The nut has a groove (1.33 cm long) for a pin. A cutting for a lever (about 1.03 cm deep) is also visible. The preserved thickness of the nut is 1.68 cm and the axis hole is 0.44 cm in diameter³¹ (Fig. 15).

In view of the oldest source information on Warsaw, which dates back to the beginning of the 14th century, we can assume the nuts can be dated to the 14th-15th century.³²

As mentioned above, the artefact from Pułtusk has a pin, and the finds from Czersk and Warsaw have the cuts for pins. From other Polish sites we know of more than 40 nuts;³³ on most of them preserved parts or signs of a metal pin, or an outline of a hole for a pin, are visible.

According to the assumptions of Payne-Gallwey and K. Wachowski, when the string was released, the lever end jumped off the nut, exposing the lower part of the nut to damage, so a pin was added to the mechanism.³⁴ All the artefacts from Mazovia

nut has been assigned to the 12th-15th century, related to the period of the functioning of the castle town.

²⁹ The nut was found next to the bridge. There is a lack of information about the layer's chronology. The inventory card of the Museum of Warsaw (Muzeum Warszawy), prepared by J. Garus.

³⁰ The nut was found in the moat. There is a lack of information about the layer's chronology. Based on the inventory card of the Museum of Warsaw (Muzeum Warszawy), prepared by J. Garus.

³¹ The nut was found in the ruins of the castle's north-west wing. There is a lack of information about the layer's chronology. The inventory card of the Museum of Warsaw (Muzeum Warszawy), prepared by J. Garus.

³² See Suchodolska 2007, 187-210; Jurek 2013, 297-299.

³³ Wojciechowski 1989, 481-486; Cnotliwy 1992, 511-512; Rębkowski 1996, 337; Cnotliwy 1999, 172-173; Wachowski 1999, 184-186; Kruppé and Milewska 2014, 100, Fig. 87, Pl. 29:3; Marek 2014, 29-31, 142, cat. nos. 23-25, Fig. 6:e,f; Nawrot and Kucia 2017, 181-183; Marek 2018, 619, Fig. 479:b-c; Michalak 2019, 173-175, 244, Pl. 88; Miścicki 2020, 298, Fig. 8; Olczak et al. 2020, 110-111, Fig. V.13, V.14; 150, Fig. V.33:4.

³⁴ Payne-Gallwey 1903, 95; Wachowski 1982, 191.

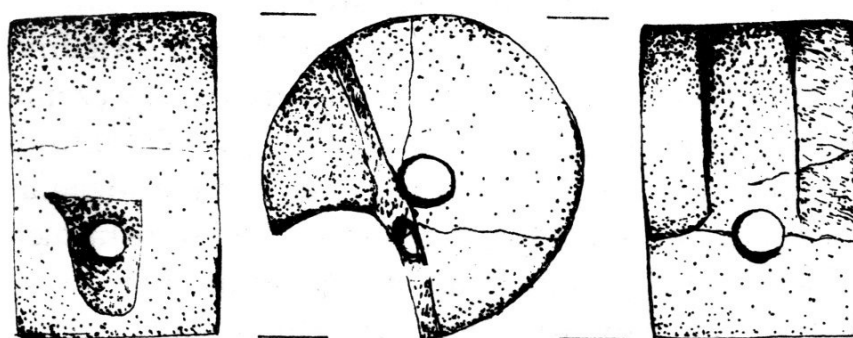

Fig. 10. Crossbow nut from Czersk. After Rauhutowa 1988, Fig. 8, drawn by S. Nowińska.

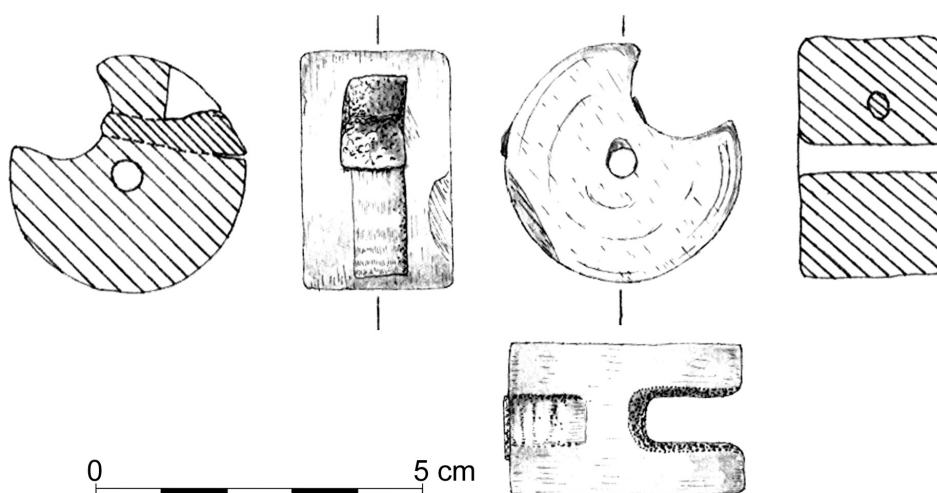

Fig. 11. Crossbow nut from Pułtusk from collections of the Regional Museum in Pułtusk. Drawn by Z. Polak.

have axis holes a feature that in Harmuth's opinion is characteristic of Central European nuts in opposition to those from Western Europe, which often do not have holes.³⁵ Generally speaking, the nuts from the territory of Poland are mostly dated to the period between the latter half of the 13th century and the 16th century.³⁶ The bigger nuts, 3-4 cm in diameter (including the nuts from Mazovia), are dated to the 14th-15th century.³⁷ This chronology should be assumed for the nut from Czersk.

The lever

A lever is another drawing element of a crossbow. This artefact was found in Lekarzice Nowe (Fig. 16) on the terrain of the conical stronghold which functioned

in the 2nd half of the 13th century.³⁸ From the terrain of Poland there are also finds from Plemięta (two finds),³⁹ Siedlątków,⁴⁰ Zbrojewsko,⁴¹ Lubniewice⁴² and from unknown location.⁴³ The artefact from Lekarzice Nowe has preserved pins placed in the upper arms, which served to mount them in the stock. These pins were used as a catch, enabling the lever to turn. Taking the probably deformed upper arm of the lever from Lekarzice Nowe into consideration, the lever most similar to it in its structure is a lever without preserved pins from Plemięta (dated before 1414) and another from

³⁸ Dragan 1978, Table II:2, according to Wojciechowski's quote Wojciechowski 1989, 485, footnote 16; Marciniak 2019, 99. About research of the stronghold in Lekarzice Nowe and its chronology, see Cieślak-Kopyt et al. 1994, 75-76.

³⁹ Kola and Wilke 1985, 115, Pl. 13:1-2.

⁴⁰ Kamińska 1968, 82, Pl. 11:1.

⁴¹ Wojciechowski 1989, 489.

⁴² Michałak 2019, 175, 245, cat. no. 165, Pl. 89:1.

⁴³ Wojciechowski 1989, 489.

³⁵ Harmuth 1986, 86, Michałak 2019, 174.

³⁶ Wojciechowski 1989, 486-487, Tab. 1.

³⁷ Serdon 2005, 152, Fig. 66; Mucha 2007, 29, according to Marek 2014, 31.



Fig. 12. Crossbow nut from Wizna from collections in the Podlaskie Museum in Białystok. Photo J. Ościłowski.



Fig. 13. Crossbow nut from Warsaw I from collections in the Museum of Warsaw. Photo J. Ościłowski.

an unknown site. Levers from Křivoklát castle (dated before 1422)⁴⁴ and a partly preserved lever from Skály castle (dated before 1440)⁴⁵ are also similar to it. Other fragments of triggers are known from Vilnius Castle, some dated to the latter half of the 14th century to the first half of the 15th century, and others dated to the first half of the 15th century.⁴⁶ All of the trigger fragments have the upper and bottom arm connected together with a link at a right, or slightly obtuse, angle. The chronology of the levers according to gathered data is between the mid-13th century and

the beginning of the 15th century. The artefact from Lekarcice Nowe is considered to be the oldest lever find in Poland. Pictures of levers are frequently seen in medieval European art.⁴⁷

Bolt rest

The bolt rests were overlays made of antler, that served to make the bolts impossible to slide down.⁴⁸ They are known from Pułtusk.⁴⁹ The first facing was

⁴⁴ Brych 2012, 35, Fig. 12:a.

⁴⁵ Brych 2012, 39, Fig. 1:5.

⁴⁶ The chronology of the lever is defined according to the layer in which it was found, Rackevičius 2006, 221-222, Fig. 6:2; Rackevičius 2007, 66, Fig. 6.

⁴⁷ Walicki 1961, Fig. 148, 150; Wąsowicz 1967, Fig. 7; Kalmár 1971, Fig. 11 on page 138; Wojciechowski 1989, 489; Richter 2006, 3, Fig. 17, 61, Fig. 46, 62, Fig. 48, 110, Fig. 85-86, 111, Fig. 88, 113, Fig. 90, 114, Fig. 92, 133, Fig. 100-101, 141, Fig. 104, 144, Fig. 107.

⁴⁸ Wojciechowski 1989, 493.

⁴⁹ Wojciechowski 1989, 493, Fig. 8:2-3.



Fig. 14. Crossbow nut from Warsaw II from collections in the Museum of Warsaw. Photo J. Ościłowski.



Fig. 15. Crossbow nut from Warsaw III from collections in the Museum of Warsaw. Photo J. Ościłowski.

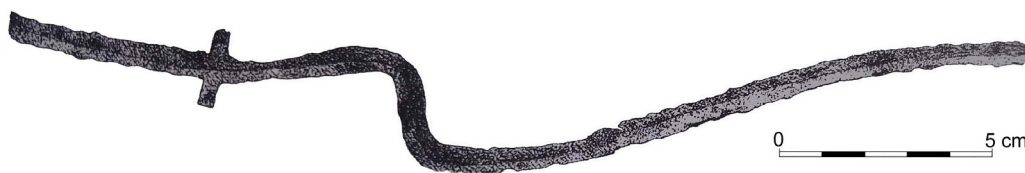

Fig. 16. Crossbow lever from Lekarzice Nowe. After Marciniak 2019, 102.

made of red deer antler. The preserved fragment is the front part – 6.4 cm long and 2.7 cm wide. The rectangular plate is slightly lifted at the front. Its front part is 0.85 cm thick (at the most) and its back part is 0.6 cm thick. The plate has four holes to fix to a stock. The holes are 0.45 cm in diameter. The plate's axis is the groove (slide) for a bolt. This groove is 0.5 cm wide and 0.25 cm deep (Fig. 17). The second find is also a fragment of the front part and has preserved the place where it narrows into the thin element. The upper chipped part of the find has visible signs of the holes which were used to fix the artefact to a stock, and it is visibly thicker on one end. The plate itself is 2 cm thick, 0.7 cm thick in its bottom narrow part. The preserved part is 8.1 cm long⁵⁰ (Fig. 18). Both facings

have cuts on their bottom sides, which were fixed to a stock. On the first facing the cuts are shaped like diagonal checks, and on the second facing the cuts are oblong shaped. These cuts probably served to better fix the elements on a stock with the use of glue.⁵¹

The chronology was defined between the latter half of the 13th century and the end of the 15th century.⁵² Slides from Poland were also found in Krosno Odrzańskie, Szczecin, Wrocław, four in Międzyrzecz (including one semi-finished product), and a few artefacts and semi-finished products in Człuchów.⁵³

⁵¹ Michalak 2019, 173. On the facing from Wrocław there are probably visible remnants of original glue, cf. Marek 2018, 618.

⁵² Polak 1988, 136.

⁵³ Cnotliwy 2014, 231-232, 383, Fig. 45, 384, Fig. 46; Marek 2018, 618-619, Fig. 479:d; Michalak 2019, 172-173, 244, cat. nos. 152-156, Pl. 87; Miścicki 2020, 292-297, Fig. 3-7.

⁵⁰ Information from D. Stabrowska (The Regional Museum, Pułtusk) and Z. Polak (The Museum of Warsaw).

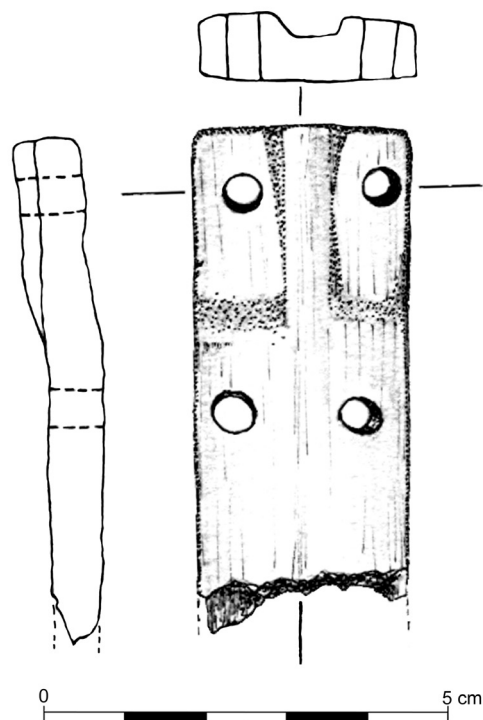

Fig. 17. Crossbow facing from Pułtusk I from collections of the Regional Museum in Pułtusk (Muzeum Regionalne w Pułtusku). Drawn by Z. Polak.

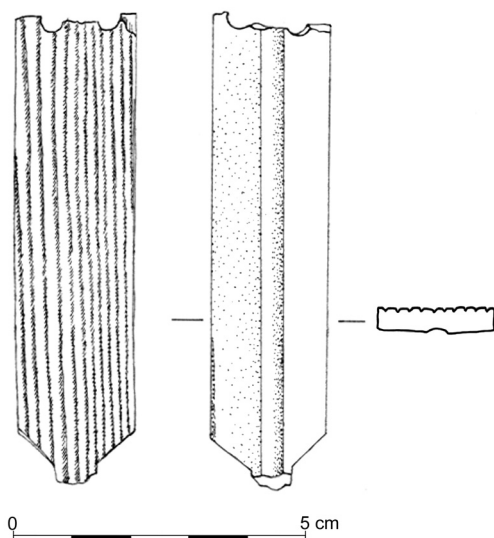

Fig. 18. Crossbow facing from Pułtusk II from collections of the Regional Museum in Pułtusk (Muzeum Regionalne w Pułtusku). Drawn by Z. Polak.

According to Mazáčkova typology, both finds from Pułtusk can be rated as type 2 – a bolt rest with a thicker front part (the thicker part is 3-4 cm long). They are dated to the 14th-15th century.⁵⁴ Two bolt rests from

Międzyrzecz also belong to this type and are dated to 14th century⁵⁵ and six from Człuchów are dated to the latter half of the 14th to the first half of the 15th century.⁵⁶ The artefacts (plate and other fragments) from Vilnius Castle and its vicinity (Lithuania) are also dated to the latter half of the 14th to the first part of the 15th-16th centuries⁵⁷ and those from Grodno (Belarus) are dated to the end of the 14th-15th century.⁵⁸

Conclusions

The oldest finds of crossbow parts from the terrain of Mazovia and Dobrzyń Land come from the Late Middle Ages. The lever from Lekarzice Nowe and the nut from Pułtusk are dated to the latter half of the 13th century. These artefacts are dated based on the layers' chronology (Pułtusk) and archaeological site (Lekarzice Nowe) and they represent types mostly characteristic of the 14th-15th century, which can help in precisely defining the chronology of both sites. Most of the rest of the finds are dated to the 14th-15th century (including the bolt rest from Pułtusk and the nuts from Wizna, Warsaw, and probably those from Czersk). More precisely dated is the stirrup from Bobrowniki (end of the 14th to the beginning of the 15th century) and the stirrup from Dobrzyń nad Wisłą (beginning of the 15th century). In my opinion, the draw hook from Liw should be dated to the 15th century. In fact, we do not have any finds which could be dated to the 12th century or to the first half of the 13th century. For this reason, at this stage of research we cannot determine the origin of the crossbows from Mazovia and Dobrzyń Land discussed in this paper. It is likely that further excavations and publications of materials discovered during the course of this or previous research will make it possible to clarify this data.

Acknowledgements

I would like to thank Urszula Sowina and Kazimierz Pacuski for their valuable comments and assistance in translating the Latin written sources.

⁵⁵ Michalak 2019, 172-173, 244, cat. nos. 153-154, Pl. 87:2-3.

⁵⁶ Miścicki 2020, 292-296, Fig. 3:1-2, 4:2-3, 5-6.

⁵⁷ The chronology of the arrow-groove plates is defined according to the layers' stratigraphy, and indirectly based on the latest finds of household ceramics, Rackevičius 2006, 216-218, 225, Fig. 3:2; Rackevičius 2007, 61-62, Fig. 3.

⁵⁸ The chronology of the arrow-groove plates is defined according to analogous finds from Wilno and Brześć (15th century), Plavinskiy et al. 2018, 81-82.

⁵⁴ Mazáčkova 2012, 357-359, Michalak 2019, 173.

Sources

- NKDM – *Nowy Kodeks Dyplomatyczny Mazowsza 3 (Dokumenty z lat 1356–1381)*, I. Sułkowska-Kuraś, S. Kuraś (eds.), Warszawa 2000.
- Vincentii Kadlubek – Magistri Vincentii dicti Kadlubek Chronica Polonorum*, ed. M. Plezia, Monumenta Poloniae Historica, s. n. XI, Kraków 1994.
- Wincenty Kadlubek – *Mistrz Wincenty Kadlubek, Kronika Polska*. Transl. and elab. B. Kurbis, Wrocław 2003.

References

- Andrzejewski A., Horonziak J. 1997. *Sprawozdanie z ratowniczych badań archeologicznych przeprowadzonych w Dobrzyniu n/Wisłą, woj. wrocławskie, na tzw. Górze Zamkowej w 1996 roku*. “Łódzkie Sprawozdania Archeologiczne” 3, 95-105.
- Bieniak J. 1986. *Kształtowanie się terytorium Ziemi Dobrzyńskiej w średniowieczu*. “Zapiski Historyczne” 51(3), 7-45.
- Brych V. (ed.) 2012. *Arma diaboli. O kuši a střelcích*. Praha.
- Cieślak-Kopyt M., Micke I., Skubicha E., Twardowski W. 1994. *Radomskie – alfabet wykopalisk. Przewodnik archeologiczny*. Radom.
- Cnotliwy E. 1992. *Szesnastowieczna kusza ze Szczecina*. “Kwartalnik Historii Kultury Materialnej” 40(4), 511-520.
- Cnotliwy E. 1999. *Wczesnośredniowieczne przedmioty z poroża i kości z Kruszwicy na Kujawach*. “Studia Archeologiczne” 31, 153-242.
- Cnotliwy E. 2014. *Archeologia Zamku Księżąt Pomorskich w Szczecinie*. Szczecin.
- Dragan B. 1978. *Badania weryfikacyjne gródka stożkowatego w Lekarcicach Nowych, gm. Promna, woj. radomskie*. Łódź. Typescript in Pracownia Konserwacji Zabytków in Radom.
- Galička I. 2006. *Sztuka gotycka*. In: H. Samsonowicz (ed.), *Dzieje Mazowsza 1*. Pułtusk, 533-557.
- Grygiel R., Jurek T. 1996. *Doliwowie z Nowego Miasta nad Wartą, Dębna i Biechowa. Dzieje rezydencji i ich właścicieli*. Łódź.
- Grześkowiak J. 1974. *Materiały z badań wykopaliskowych przeprowadzonych w 1969 roku na Górze Zamkowej w Dobrzyniu nad Wisłą, pow. Lipno*. “Acta Universitatis Nicolai Copernici. Archeologia” 4, Nauki Humanistyczno-Społeczne 60, 211-232.
- Harmuth E. 1986. *Die Armbrust: Ein Handbuch*. Graz.
- Horbacz T. J. 1983. *Warownia w Bobrownikach*. “Z Otchłani Wieków” 49(3), 154-163.
- Horbacz T. J. 1985. *Z badań nad zamkiem bobrownickim w ziemi dobrzyńskiej*. “Ziemia Kujawska” 7, 71-113.
- Horbacz T. J. 1995. *Zamek w Bobrownikach, dzieje i konserwacja, zarys problematyki*. In: O. Krut-Horonziak, L. Kajzer (eds.), *Stolica i region. Włocławek i jego dzieje na tle przemian Kujaw i Ziemi Dobrzyńskiej. Materiały z sesji naukowej (9-10 maja 1994 roku)*. Włocławek, 145-154.
- Jarzębska J. 1972. *Grodzisko w Wiźnie, pow. Łomża, w świetle badań prowadzonych w latach 1968-1970*. Typescript in Pracownia Konserwacji Zabytków in Warszawa.
- Jurek T. (ed.). 2013. *Słownik historyczno-geograficzny ziemi warszawskiej w średniowieczu*. Warszawa.
- Kalmár J. 1971. *Régi magyar fegyverek*. Budapest.
- Kamińska J. 1968. *Siedlątków, obronna siedziba rycerska z XIV w.* “Prace i Materiały Muzeum Archeologicznego i Etnograficznego w Łodzi. Seria Archeologiczna” 15, 16-88.
- Karłowska-Kamzowa A. 2004a. *Malarstwo ścienne w Wielkopolsce, na Kujawach i Mazowszu*. In: A. S. Labuda, K. Secomska (eds.), *Malarstwo gotyckie w Polsce. Synteza*. Warszawa, 111-116.
- Karłowska-Kamzowa A. 2004b. *Malarstwo książkowe na Mazowszu i Kujawach*. In: A. S. Labuda, K. Secomska (eds.), *Malarstwo gotyckie w Polsce. Synteza*. Warszawa, 459-465.
- Kochanowska-Reiche M. 2003. *Mistyczne Średniowiecze / The mystic Middle Ages*, L. Majewski (book design), J. Holzmann (English transl.), Skarby Muzeum. Olszanica.
- Koczorowska-Pielińska E. 1983. *Rzemiosło Starej i Nowej Warszawy do 1525 r.* In: B. Grochulska, W. Pruss (eds.), *Z dziejów rzemiosła warszawskiego*. Warszawa, 27-88.
- Kola A., Wilke G. 1985. *Militaria z grodziska w Plemiętach. Broń strzelcza*. In: A. Nadolski (ed.), *Plemięta. Średniowieczny gródek w ziemi chełmińskiej*. Warszawa, Poznań, Toruń, 107-128.

- Kruczek J. 2002. *Kusze. Katalog zbiorów*. Pszczyna.
- Kruczek J. 2013. *Kusze i ich twórcy*. Pszczyna.
- Kruppé J., Milewska M. 2014. *Dzieje zamku w Pucku*. Warszawa.
- Labuda A. S. 2004. *Malarstwo tablicowe w Wielkopolsce, na Kujawach i Mazowszu*. In: A. S. Labuda, K. Secomska (eds.), *Malarstwo gotyckie w Polsce. Synteza*. Warszawa, 311-332.
- Labuda A. S., Secomska K. (eds.) 2004. *Malarstwo gotyckie w Polsce. Katalog zabytków*. Warszawa.
- Marciniak W. 2019. *Szlakiem grodzisk powiatu białobrzesckiego. Przewodnik archeologiczny*. Radom.
- Marek L. 2014. *Europejski styl. Militaria z Elbląga i okolic*. Studia Archeologiczne 47. Acta Universitatis Wratislaviensis 3543. Wrocław.
- Marek L. 2018. *Militaria*. In: J. Piekalski, K. Wachowski (eds.), *Rytm rozwoju miasta na kulturowym pograniczu. Studium strefy Placu Nowy Targ we Wrocławiu*. Wratislavia Antiqua 23. Wrocław, 563-711.
- Mazáčková J. 2012. *Militária z hradu Rokštejn v širším středoevropském kontextu / Military equipment of the castle Rokštejn in wider centraleuropean context*. <https://theses.cz/id/7h7jky/>. Masarykova univerzita, Filozofická fakulta. Brno.
- Michalak A. 2019. *Arma Confinii. Przemiany późnośredniowiecznej broni na rubieżach Śląska, Wielkopolski, Brandenburgii i Łużyc*. Zielona Góra.
- Miścicki M. 2020. *Pozostałości krzyżackiego warsztatu kuszniczego na zamku w Człuchowie*. "Kwartalnik Historii Kultury Materialnej" 68(3), 289-313.
- Mucha B. 2007. *Kusza – średniowieczna broń strzelcza w Polsce na tle Europy*. Typescript in the archive of the Archaeology Institute of the University of Wrocław. Wrocław.
- Muzolf B. 1994. *Wielokulturowy zespół archeologiczny na Górze Birów w Pozdamczu, gm. Ogrodziniec, woj. Katowickie*. "Łódzkie Sprawozdania Archeologiczne" 1, 131-147.
- Nawrot J., Kucia A. 2017. *Orzech kuszy i grot beltu z Krakowa*. "Acta Militaria Mediaevalia" 13, 181-186.
- Olczak H., Paczobut N., Kiziukiewicz N. 2020. *Wyniki badań wykopaliskowych przeprowadzonych na suraskim grodzisku w 1936 r.* In: D. Krasnodębski, H. Olczak (eds.), *Suraz – średniowieczny gród na pograniczu mazowiecko-rusko-litewskim*. Warszawa, 75-151.
- Pacuski K. 2016. *Ciechanów średniowieczny na tle dziejów Mazowsza w świetle źródeł pisanych*. In: A. K. Sobczak (ed.), *Ciechanów. Szkice z historii miasta*. Ciechanów, 45-61.
- Payne-Gallwey R. 1903. *The Crossbow. Its Construction, History and Management*. London.
- Plavinskiy N. A., Kizyukevich N. A., Plavinskiy V. A. 2018. *Nakhodka detaley arbaletov na territorii Zamkovoy Gory v Grodno*. In: O. V. Dvurechenskiy (ed.), *Voyennaya arkeologiya. Sbornik materialov nauchnogo seminara 4*. Moskva, 77-88.
- Rackevičius G. 2002. *Arbaletas ir lankas Lietuvoje XIII-XVI a.* Vilnius.
- Rackevičius G. 2006. *Vilnius Crossbow Workshops in the late Middle Ages (Second Half of the 14th Century – First Half of the 15th Century)*. "Quaestiones Medii Aevi Novae" 2, 211-226.
- Rackevičius G. 2007. *The Crossbow – The Weapon of the Invaders and the Defenders of Vilnius castle (the late 14th – early 15th centuries)*. "Fasciculi Archaeologiae Historicae" 20, 59-70.
- Rauhutowa J. 1988. *Czersk we wczesnym średniowieczu w świetle badań z lat 1974–1983*. In: G. Labuda, S. Tabaczyński (eds.), *Studia nad etnogenezą Słowian i kulturą Europy wczesnośredniowiecznej 2*. Wrocław, 107-116.
- Rębkowski M. 1996. *Wyroby z rogu i kości, bursztynu, kamienia, szkła oraz gliny*. In: M. Rębkowski (ed.), *Archeologia Średniowiecznego Kołobrzegu 1: Badania przy ulicy Ratuszowej 9-13*. Kołobrzeg, 337-344.
- Richter H. 2006. *Die Hornbogenarmbrust. Geschichte und Technik*. Ludwigshafen.
- Serdon V. 2005. *Armes du diable. Arcs et arbalètes au Moyen Âge*. Rennes.
- Suchodolska E. 2007. *Źródła pisane do dziejów Zamku książąt mazowieckich w Warszawie*. "Kronika Zamkowa" 1-2(53-54), 187-210.
- Sygetyńska H. 2006. *Sztuka i rzemiosło artystyczne*. In: H. Samsonowicz (ed.), *Dzieje Mazowsza 1*. Pułtusk, 559-571.
- Szymczak J. 1990. *Organizacja produkcji i ceny uzbrojenia*, In: A. Nadolski (ed.) *Uzbrojenie w Polsce średniowiecznej 1350-1450*. Łódź, 208-382.
- Szymczak J. 1995. *Rzemiosło zbrojeniowe i zasoby uzbrojenia na Kujawach i w ziemi dobrzyńskiej w średniowieczu*. In: O. Krut-Horonziak, L. Kajzer (eds.), *Stolica i region. Włocławek i jego dzieje na tle przemian Kujaw i Ziemi Dobrzyńskiej. Materiały z sesji naukowej (9-10 maja 1994 roku)*. Włocławek, 61-68.
- Szymczak J. 2017. *Rycerz z bronią zaczepną*. Warszawa, Bellerive-sur-Allier.

- Urbańczyk P. 2016. *Fazy użytkowania Wzgórza Zamkowego w Czersku ustalone na podstawie badań z lat 1974-1983*. In: P. Urbańczyk, M. Trzeciecki (eds.), *Czersk Wzgórze Zamkowe. Badania 1974-1983*. Origines Polonorum 10. Warszawa, 69-130.
- Wachowski K. 1982. *Średniowieczna broń miotająca na Śląsku w świetle znalezisk z Ostrówka w Opolu*. "Archeologia Polski" 27(1), 167-202.
- Wachowski K. 1999. *Militaria*. In: C. Buśko, J. Piekalski (eds.), *Ze studiów nad życiem codziennym w średniowiecznym mieście. Parcele przy ulicy Więziennej 10-11 we Wrocławiu*. Wratislavia Antiqua 1. Wrocław, 183-186.
- Walicki M. 1961. *Malarstwo polskie. Gotyk, renesans, wczesny manieryzm*. Warszawa.
- Wawrzykowska B., Grześkowiak J. 1978. *Badania ratownicze na Górze Zamkowej w Dobrzyniu nad Wisłą, pow. Lipno*. "Komunikaty Archeologiczne" 1, 275-284.
- Wąsowicz T. 1967. *Legenda śląska*. Wrocław.
- Wojciechowski T. 1989. *Znaleziska fragmentów kusz na ziemiach polskich*. "Kwartalnik Historii Kultury Materialnej" 37(3-4), 481-495.

