

STANISŁAW LEWKOWICZ

## Zmiany chemiczne w wodzie i akumulacyjnej warstwie gleb stawów użyźnianych ściekami cukrowniczymi

### Chemical changes in the water and accumulation stratum of soils in ponds fertilized with beet-sugar factory wastes

Wpłynęło 15 marca 1972 r.

**Abstract** — The processes of self-purification of sugar factory wastes in fish ponds (1967—1968) as well as the primary production of phytoplankton were investigated. The time of mineralization of the wastes lasted from 3—6 months and depended on the concentration or dilution of organic matter in them. During the time the waste waters were in the ponds 4 stages were distinguished: 1) heterotrophy, 2) hyperautotrophy, 3) transition, 4) stabilization.

In the examined ponds a complete disintegration of organic matter introduced with the sewage was established, as no accumulation of organic matter was found in the pond soils towards the end of the vegetative season. Fish yield was several times higher in ponds fertilized with sugar factory wastes than in control ponds.

Due to the campaign character of the sugar industry, great amounts of wastes are released into the rivers in a relatively short period of time. These waters cause such enormous changes in the water environment that, at that time, smaller rivers turn into ordinary sewers (Michalski 1951) and lakes and larger rivers show a considerable increase in organic and mineral matter (Schiemenz 1902, Stangenberg 1958, Stangenberg-Oporowska, Solski 1964).

Beet sugar factory wastes may influence the receiver in various ways. Decantation of mineral and organic compounds makes the bottom slimy and leads to the formation of deposits. The greatest physico-chemical changes in the receiver are caused by a high content of organic matter in the waste waters, which, disintegrating slowly, pollute the river water at a great distance from where they were released in. Often a secondary pollution takes place, caused by a sudden disintegration of bacteria and

fungi developing in the vicinity of the inlet into the receiver (Star-mach 1960). Secondary pollution may cause, in the warm seasons of the year, also sudden disintegration of the bottom sediments.

There are serious difficulties in purification of the sugar wastes. Because of the campaign character of the beet sugar industry certain biological methods of purification cannot be applied to any great extent; the low temperature during the beet sugar campaign (from  $+3.7^{\circ}\text{C}$  in November to  $-2.3^{\circ}\text{C}$  in January) complicates biological purification of these wastes. They are usually purified in sedimentation basins and on filtration fields where mineral and organic suspensions are sedimented.

The possibility of purifying and utilizing sugar campaign industrial wastes in fish ponds was mentioned for the first time by Pytlik (Pytlik, Votava, Beneš 1954, Pytlik 1957, Pytlik et al. 1957). His method consists in accumulating the wastes in fish ponds and, after self-purification, in populating the ponds with carp. He advised liming in the amount 50—75 q/CaO/ha in order to accelerate the mineralization process of the wastes and to prevent acidic fermentation. In his opinion the duration of mineralization was from 3 to 3.5 months and after the autumn flooding with wastes the pond could be stocked with carp in the spring.

The possibility of utilizing organic wastes for the fertilization of ponds was already known earlier. For the most part ponds were fertilized with municipal sewage (Demoll 1926, Kisskalt, Ilzhofer 1937). The method consisted in purifying the crude sewage in the pond in oxygen conditions. As the sewage contained great amounts of organic matter it proved necessary to mix it with large amounts of pure water. The degree of dilution had to be often corrected because of the various chemical composition of the sewage. Another method of carp breeding in ponds filled with municipal sewage was applied near Moscow (Mejen 1932). This method consisted in building ponds connected one with another in order to permit the sewage to pass successively through each pond. In the first ponds disintegration of organic matter and liberation of mineral compounds took place in anaerobic conditions. These processes caused, in successive ponds, a mass development of phytoplankton. Owing to the latter's intensive photosynthesis in the final ponds the aerobic conditions permitted the stocking of these ponds with fish.

In Poland investigations on fish breeding in ponds filled with sewage were carried out by Wolny (1962 a, 1962 b). These concerned municipal sewage with a low content of organic matter after biological purification and differing from the wastes which are the subject of the present paper.

A great advantage of Pytlik's method is that the self-purification of sugar campaign wastes takes place directly in the fish ponds in a season of the year which, from the fishery point of view, (autumn and winter) is unproductive.

In Czechoslovakia investigations on the self-purification of sugar factory wastes in fish ponds were carried out by Sladeček and co-workers (1958), special attention being paid to the succession of phyto- and zooplankton in the accumulation pond. Pytlík's method was applied in several beet sugar factories in the Ukraine (Sivko, Lachnovič 1967, Prosjanyj et al. 1965, Makina 1967, Antipčuk, Makina, Francuzova 1969), the main stress being laid on the influence of liming on the rate of the mineralization process and the effect of wastes on the development of the zooplankton and benthos as a nutritive basis for fish. Ilčenko and Matvenko (1969) suggested the possibility of accelerating the process of sewage mineralization by inoculating the sewage with some species of algae.

Liming of the waters, so strongly emphasized by Pytlík, did not give explicit results in all these investigations. In the Soviet studies the time required for the self-purification process was longer than that recorded in Czechoslovakia. With respect to sewage with a high contamination charge dilution may prove necessary in order to shorten the period of self-purification and make these ponds usable for fishery purposes.

The present paper constitutes a part of complex investigations carried out on the initiative of Assistant Prof. Stanisław Wróbel by the Laboratory of Water Biology of the Polish Academy of Sciences in Cracow and concerns the self-purification process of beet-sugar factory wastes in fish ponds. The paper aims at elaborating the following problems: determination of the mineralization of wastes with various contents of organic matter, the transformation and dynamics of the more important mineral components in the pond water, the primary production of phytoplankton and the oxygen conditions in the ponds connected with it, the influence of wastes on the physico-chemical properties of the pond bottom and the consequent effect of the wastes in the second year of exploitation of the pond.

### Investigation terrain and method

Experiments carried out in the years 1967—1968 in four productive ponds of the „Mnich” pond complex belonging to the Experimental Fishery. Farm of the Laboratory of Water Biology of the Polish Academy of Sciences at Golysz in the district of Cieszyn. The ponds of the „Mnich” complex were built on silt soils of water origin (Pasternak 1959). The ponds were supplied with water from the River Bajerka, the water being poor in mineral compounds of phosphorus and nitrogen which only in spring amounted to 2 mg N-NO<sub>3</sub>/l (Sowa 1959, Wróbel 1965 b). Particularly small is the amount of calcium, not exceeding 20 mg Ca/l and potassium — 2 mg K/l. Owing to the low concentration of electrolytes, including mineral

nutrient compounds in the inflowing waters, this complex is characterized by the lowest production of fish in all the ponds at Gołysz.

The ponds of the „Mnich” complex are situated about 1 km from the sugar factory at Chybie (fig. 1). The ponds Polny III and Łąkowy were flooded with beet sugar factory wastes from the 1966/67 sugar campaign (Table I). The wastes were taken from the collector running along the „Mnich” complex of ponds by means of an electric pump, and let in at one point near the dam in the deeper part of the ponds.

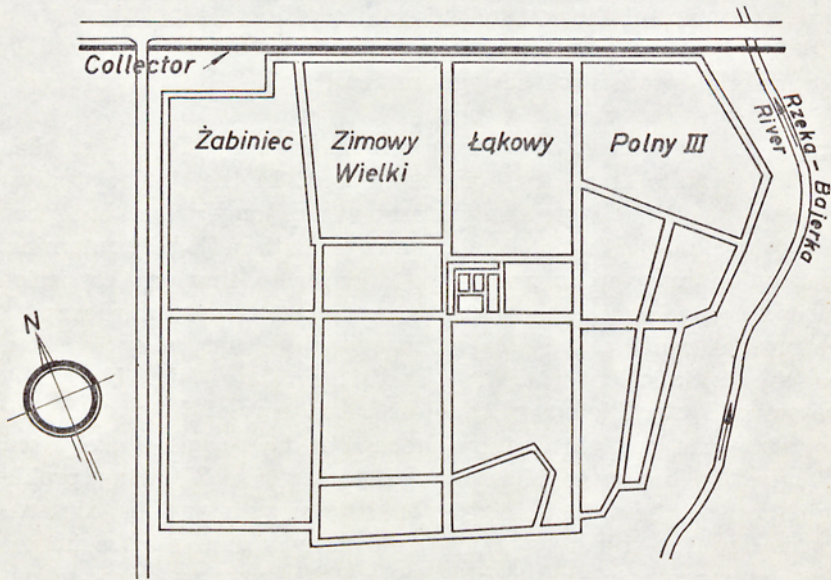

Ryc. 1. Plan sytuacyjny kompleksu stawowego „Mnich”

Fig. 1. Site plan of the „Mnich” pond complex

Waste waters brought into the pond were not homogeneous and originated from various production departments thus varying greatly in composition (Table II). The wastes were mixed with domestic sewage, constituting 10 to 15 per cent of the total amount of sewage released into the ponds. During the first two months wastes were taken directly from the factory but in February, after the campaign had ended, they were taken from filtration fields.

The greatest variability during the inflow of sewage occurred in the amounts of organic matter. Both oxidability and COD were higher in the first two months and much lower when the sewage was taken from filtration fields.

The sewage was released into the pond in such a way as to obtain a different concentration of organic matter in two ponds. The pond Polny III was flooded with wastes with a high degree of pollution taken directly from the beet sugar factory; only in the final phase of flooding did small

Tabela I. Charakterystyka stawów rybnych użytkowanych jako zbiorniki akumulacyjne przy oczyszczaniu ścieków cukrowniczych  
 Table I. Charakter of fish ponds used as accumulation reservoirs in purifying sugar factory wastes

Staw Pond	Polny III	Żaków	Zimowy Wielki	Żabiniac
Powierzchnia ha	9.0	8.1	8.0	10.0
Średnia głębokość m	1.3	1.1	0.9	0.8
Okres napełniania stawów ściekami Time of filling with wastes	15.XII.1966 - 45.II.1967	2.I.1967 - 20.II.1967	30.XI.1967 - 15.I.1968	30.XI.1967 - 15.I.1968
Rodzaj ścieków Kind of wastes	Mieszane bez oczyszczania na polach filtracyjnych Mixed without purification on filtration fields	Mieszane po oczyszczeniu na polach filtracyjnych Mixed after purification on filtration fields	Mieszane bez oczyszczania na polach filtracyjnych Mixed without purification on filtration fields	Mieszane bez oczyszczania na polach filtracyjnych Mixed without purification on filtration fields
Rozcieńczenie Dilution	Bez rozcieńczenia Without dilution	Rozcieńczone With dilution	Rozcieńczone With dilution	Rozcieńczone With dilution
Użytkowanie stawu Use of pond	2 lata 1967 - 1968 2 years	Jeden rok (1967) w 1968 staw napełniony wodą czystą One year (1967) in 1968 pond filled with pure water	Jeden rok (1968) One year	Jeden rok (1968) One year
Wapnowanie Liming	7.5 t/ha	1.0 Na cz.śc wypływną stawu In shallow parts of pond	2.8	Nie wapnowano Without liming

amounts of wastes come from filtration fields. In the pond Łąkowy most of the wastes come from filtration fields, while only in the initial phase was the pond filled with small amounts of wastes taken directly from the sugar factory. In order to obtain a greater differentiation in the chemical composition of the wastes the pond Łąkowy was 1/8 floded with clean water before being filled with wastes; a reserve was left so that after filling it up in the ratio of wastes and clean water was 4 : 1.

Tabela II. Charakterystyka fizyko-chemiczna ścieków doprowadzanych do stawów Polny III i Łąkowy

Table II. Physico-chemical character of wastes released into the ponds Polny III and Łąkowy

Czynniki Factors	Data Date	1966			1967			
		6.XII	13.XII	20.XII	6.I	23.I	2.II	10.II
Temperatura Temperature	°C	6,0	8.5	12.5	16.5	2.6	2.0	2.5
pH		6.5	5.6	6.6	6.7	6.6	6.8	7.0
Alkaliczność ogólna Total alkalinity	me/l meq/l	15.5	16.6	15.8	28.3	27.4	16.0	8.8
Twardość ogólna Total hardness	°n °g	48.0	52.0	41.0	74.0	75.0	43.0	23.5
Azot amonowy Ammonia nitrogen	N mg/l	-	-	-	30.4	7.0	3.8	1.3
Azot ogólny Total nitrogen	N mg/l	-	-	41.0	72.9	45.6	21.3	9.3
Sód Sodium	Na mg/l	-	-	-	-	36.0	33.0	56.0
Potas Potassium	K <sub>2</sub> O mg/l	-	-	-	-	95.0	70.0	68.5
Utleniałość Oxidability	O <sub>2</sub> mg/l	147.2	271.2	232.5	232.5	152.0	46.5	26.6
ChZT COD	O <sub>2</sub> mg/l	1820	2280	1368	2049	2130	852	315

The ponds Zimowy Wielki and Żabiniec were filled with wastes during the 1967/68 sugar campaign. Wastes were introduced directly from the sugar factory, filtration fields not being used.

The chemical content of the wastes released into the ponds were not homogeneous (Table III), their chemical properties being similar to those in the preceding year.

The mixed sewage with which the ponds were filled consisted of the surplus of various kinds of recirculated waters and wastes after treatment in the Nolte biological purification plant.

a) Mixed sewage before purification on filtration fields. These wastes were characterized by a slightly acid reaction and a high degree of pollution with mineral and organic matter (Table IV). Nitrogen and phosphorus were found in greater amounts in organic compounds. Small amounts of nitrate and nitrite, undergoing rapid reduction in these conditions, might have originated from the beet flume wastes.

b) Mixed sewage after purification on filtration fields. These wastes were returned to the sugar factory and used as industrial water.

Tabela III. Charakterystyka fizyko-chemiczna ścieków doprowadzanych do stawów Żabiniec i Zimowy Wielki

Table III. Physico-chemical character of wastes released into the ponds Żabiniec and Zimowy Wielki

Czynniki Factors	Data Date	1967			1968
		4.XII	7.XII	18.XII	4.I
Temperatura Temperature	°C	19.9	25.0	16.3	17.0
pH		5.0	6.2	6.8	6.1
Alkaliczność ogólna Total alkalinity	me/l meq/l	12.0	11.8	23.2	16.0
Twardość ogólna Total hardness	Ca Mg	44.5	43.5	93.0	54.0
Mętność Turbidity	SiO <sub>2</sub> mg/l	1475	1550	3400	2000
Azotyny Nitrite nitrogen	N mg/l	Ślady Traces	0.22	0.10	0.20
Azotany Nitrate nitrogen	N mg/l	0.343	0.15	0.137	0.41
Azot amonowy Ammonia nitrogen	N mg/l	10.8	14.5	17.0	4.0
Azot ogólny Total nitrogen	N mg/l	37.34	32.01	46.16	34.21
Fosfor mineralny Phosphate phosphorus	P mg/l	1.27	0.88	7.01	0.33
Fosfor ogólny Total phosphorus	P mg/l	7.17	7.66	15.16	7.50
Sód Sodium	Na mg/l	25.0	25.0	29.0	30.0
Potas Potassium	K <sub>2</sub> O mg/l	165.0	138.0	247.0	174.0
Utlenialność Oxidability	O <sub>2</sub> mg/l	296.0	307.0	232.0	1368.0
ChZT COD	O <sub>2</sub> mg/l	1751.0	1536.0	1680.0	2904.0
BZT BOD <sub>5</sub>	O <sub>2</sub> mg/l	1120	960	1040	1000

A great influence of filtration fields upon the physico-chemical properties of the wastes passing through them is observed. The reaction changed from acid to alkaline, turbidity and oxidability decreased 4 times, and the content of organic matter (COD and BOD<sub>5</sub>) about twice. The total amount of nitrogen and phosphorus decreased in the same degree as organic matter. The content of sodium and potassium as well as the total amount of calcium and magnesium decreases at a lower degree than that of organic matter.

It results from the presented data that the wastes from „Chybie” sugar factory contain a great charge of organic matter and cannot be released directly into the receiver. All kinds of wastes should be subjected, before being released into the receiver, to further biological treatment in accumulation reservoirs which in the case of the „Chybie” sugar factory are in the form of filtration fields and fish ponds.

Water for analysis was sampled at one point about 50 m distant from the outlet box, an average sample from the whole water column being taken. Only for some analyses was water sampled every 50 cm in vertical

Tabela IV. Charakterystyka fizyko-chemiczna ścieków mieszanych przed i po oczyszczeniu na polach filtracyjnych  
 Table IV. Physico-chemical character of mixed wastes before and after purification on filtration fields

Czynnik Factors	Data Date		Przed oczyszczeniem na polach filtracyjnych Before purification on filtration fields				Po oczyszczeniu na polach filtracyjnych After purification on filtration fields			
			1967		1968		1967		1968	
	11. I	21. XI	18. XII	4. I	18. I	11. I	21. XI	18. XII	4. I	18. I
Temperatura Temperature	17.8	23.8	27.5	26.0	20.8	2.9	5.0	0.4	2.1	2.8
pH	6.2	5.7	6.2	6.3	6.3	6.7	6.8	6.9	6.8	6.6
Alkaliczność ogólna. Total alkalinity	22.0	20.0	30.2	23.8	25.8	26.0	22.0	23.2	19.4	20.6
Twardość ogólna Total hardness	94.0	92.0	121.0	83.0	93.0	84.0	73.0	69.5	56.6	68.5
Mętność Turbidity	-	3800	4250	2700	4625	-	800	900	900	1300
Azotyny Nitrite nitrogen	0.075	0.01	Ślady Traces	0.05	0.02	Ślady Traces	Ślady Traces	Ślady Traces	Ślady Traces	Ślady Traces
Azotany Nitrate nitrogen	0.26	0.18	0.17	0.14	0.17	Ślady Traces	Ślady Traces	Ślady Traces	Ślady Traces	Ślady Traces
Azot amonowy Ammonia nitrogen	-	2.00	11.50	4.25	1.25	-	3.5	4.25	10.0	5.0
Azot ogólny Total nitrogen	60.26	51.15	69.61	40.51	48.35	32.70	19.15	22.51	24.79	25.49
Fosfor mineralny Phosphate phosphorus	2.28	3.13	8.48	1.63	3.26	2.04	2.48	1.71	2.15	2.57
Fosfor ogólny Total phosphorus	12.71	13.04	17.60	12.55	14.02	6.52	6.19	6.85	6.68	7.99
Sód Sodium	61.0	36.0	57.0	32.0	37.0	58.0	26.0	36.0	32.0	31.0
Potas Potassium	170.0	202.0	247.0	207.0	275.0	155.0	116.0	122.5	165.0	155.0
Ujemnałość Oxidability	465.0	443.0	472.0	533.0	486.0	89.1	83.3	70.85	109.8	113.7
ChZT COD	2960.0	3356.0	2903.0	2756.0	2312.0	1776.0	1818.0	1436.0	1126.0	1505.0
BZT5 BOD5	1280	1120	1840	1600	1440	1040	640	900	800	1040



section by means of a Ruttner type bathometer. Samples were collected between 8 and 9 a. m. In 1967 the water was sampled every 10 days and in 1968 every two weeks. At the time of a lower rate of biological processes in winter, samples were collected at longer time intervals.

In collecting samples from the bottom sediments the pond was divided into a shallow and a deeper part as great differentiation in the physico-chemical properties of the soil is often encountered in these two parts. From each part an average sample was collected from about 20 points. In the pond Polny III, where at one time samples were collected when the pond was filled up, a Morduchaj-Boltovski type probe was used. This permitted the collection of samples without disturbing the top layers of the bottom sediments.

The majority of analyses were made according to the usually applied methods given for water by Just and Hermanowicz (1964) and for soils by Lityński, Jurkowska, and Gorlach (1962).

For determination of the COD the dichromate method was applied, using  $\text{AgSO}_4$  as a catalyser (in most cases of analysis after evaporation). For wastes with a high content of organic matter no evaporation was applied, only the same ratio of  $\text{H}_2\text{SO}_4$  to water 1 : 1 being maintained. Combustion was carried out at 180 °C for 5 minutes.

Total phosphorus was determined according to the Einsele method (Czensńy 1961). The chlorophyll in the phytoplankton was determined in acetone extract applying Soviet No 5 membrane filters.

Extinction was measured on a Spekol photocolormeter at a wavelength of 663 nm. The calibration curve was drawn on the basis of Sandoz „a” standard chlorophyll. Primary production was measured by means of the oxygen method of light and dark bottles.

### **Self-purification processes of wastes in the light of the physico-chemical parameters of the water**

In order to accelerate the process of mineralization of the waters released into the pond Polny III, the pond was limed with slaked lime in the amount of 7.5 t per 1 ha, 2.5 t of it being spread on the bottom of the pond before flooding and the rest thrown on to the water in March and April. During the first month a considerable decrease in  $\text{BOD}_5$  and COD (fig. 2) was observed, this being caused by sedimentation of organic and mineral suspension (fig. 3), a process favourably influenced by winter stagnation. The dilution effect caused by the thawing ice cover should also be taken into consideration, this possibly causing a fall in the content of organic matter amounting to 10 to 15 per cent (the pond had completely thawed in the last days of February). Oxidability and turbidity of the

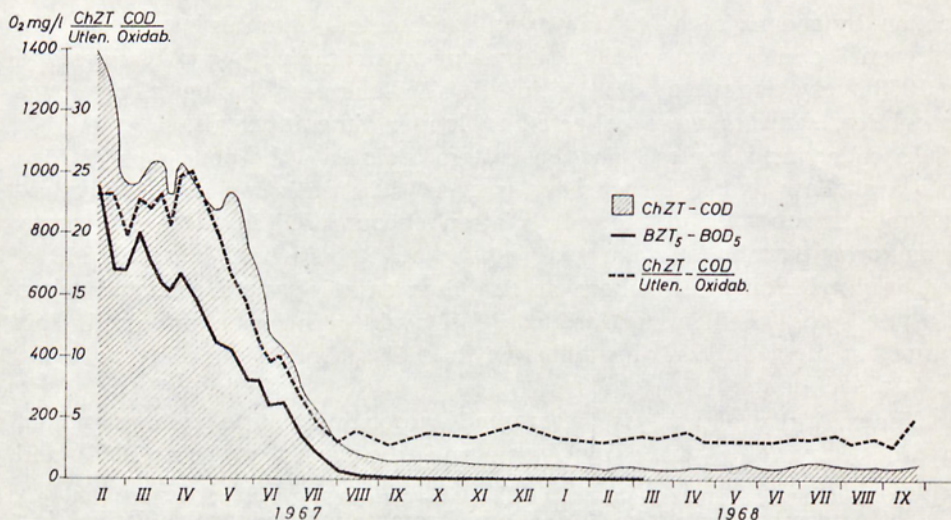

Ryc. 2. Chemiczne i biologiczne zapotrzebowanie tlenu wody w stawie Polny III  
 Fig. 2. BOD<sub>5</sub> and COD of the water of the pond Polny III

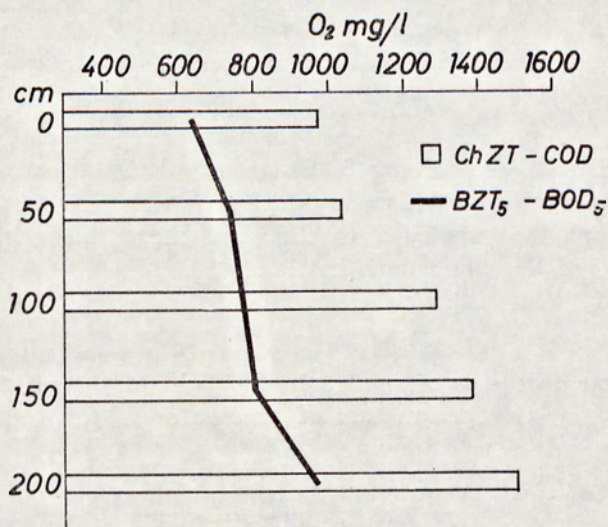

Ryc. 3. Chemiczne i biologiczne zapotrzebowanie tlenu podczas stagnacji zimowej w wodach stawu Polny III

Fig. 3. BOD<sub>5</sub> and COD during winter stagnation in the water of the pond Polny III

wastes in the phase of mineralization cannot be treated as an indicator of the amount of organic matter in the waters (fig. 4). Organic matter in sugar factory wastes is oxidized only slightly by permanganate. In the first three months oxidability constituted less than 5 per cent of the matter oxidized by bichromate of potassium (fig. 2). Z d y b n i e w s k a (1969) and

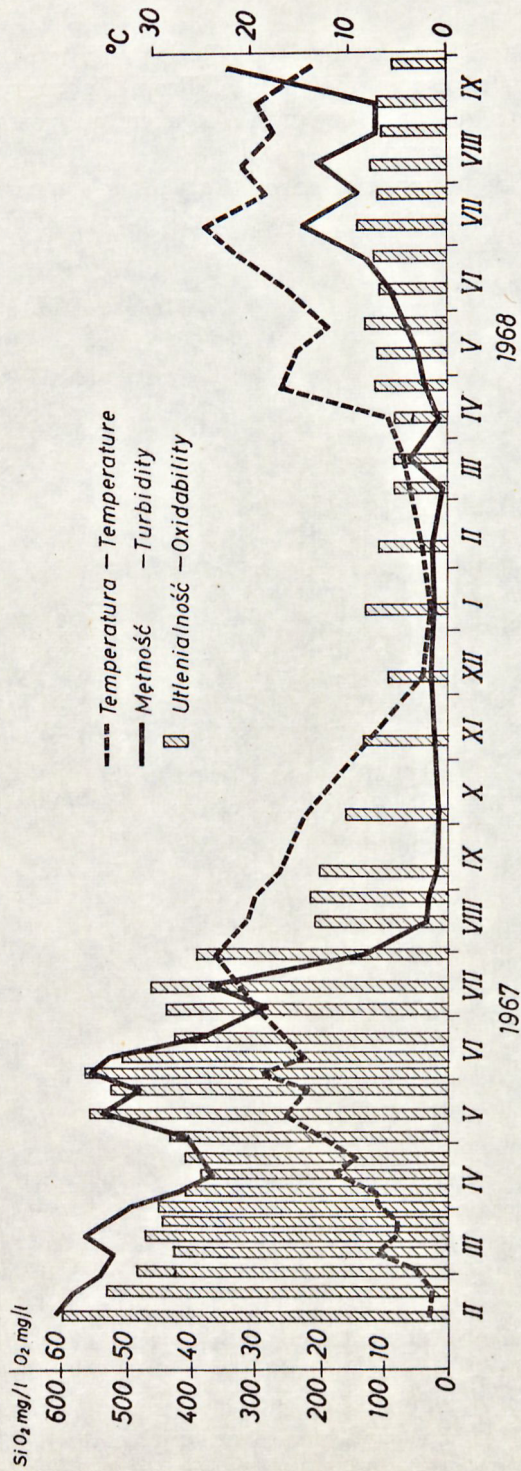

Ryc. 4. Temperatura, mętność i utleniałość wody w stawie Polny III  
 Fig. 4. Temperature, turbidity and oxidability of the water of the pond Polny III

Koła czkowski and Meybaum (1962) also mention the low degree of oxidability of wastes by permanganate. From February to June no pronounced differences in oxidability with a concomitant remarkable fall in BOD<sub>5</sub> and COD were observed.

Towards the end of mineralization of the wastes a mass development of plankton algae and concomitant photosynthetic oxygenation of the water

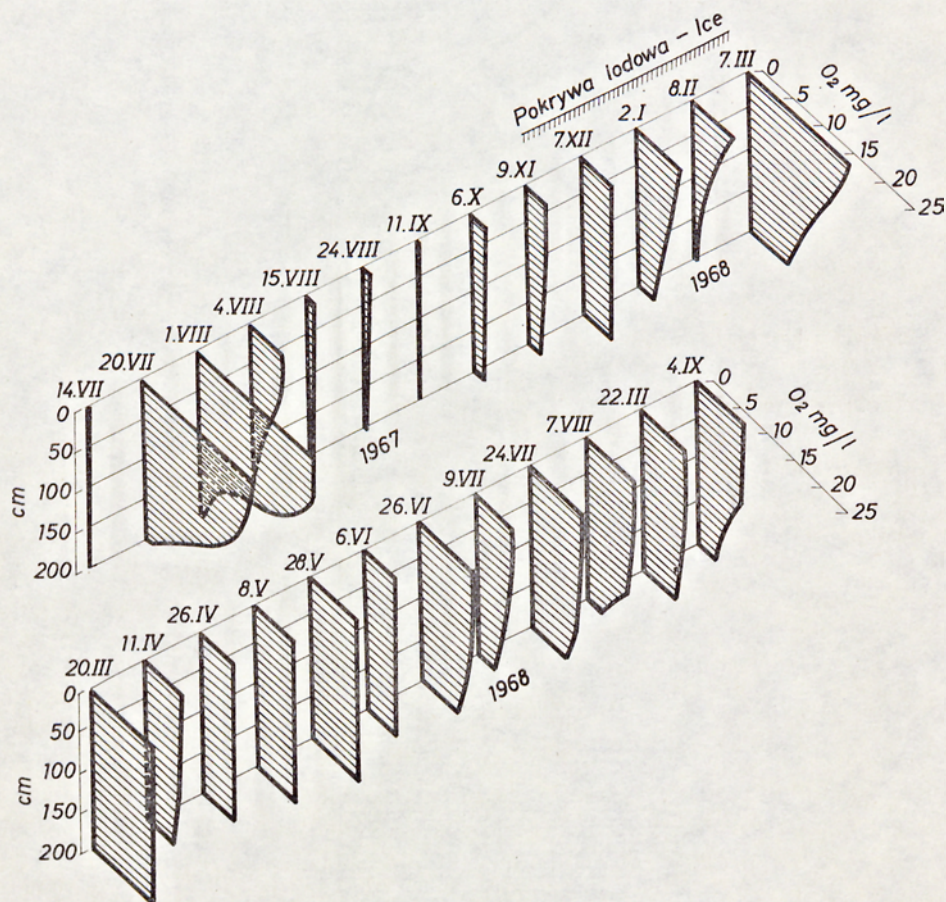

Ryc. 5. Zawartość tlenu w wodzie stawu Polny III

Fig. 5. Oxygen content in the water of the pond Polny III

with a low BOD<sub>5</sub> changed the prevailing anaerobic conditions to aerobic ones (fig. 5). In the pond Polny III the first amounts of oxygen dissolved in the water were found in the last days of July with a COD below 200 mg O<sub>2</sub>/l and BOD<sub>5</sub> below 50 mg O<sub>2</sub>/l. In this period of time trace amounts of oxygen were found in the surface layers, whereas a distinct differentiation in the vertical profile of the two kinds of organic matter — that of waste origin at the bottom and the newly formed one at the surface due to the

development of algae (fig. 6). In the first aerobic period turbidity and oxidability depended on the amount of plankton algae. The mentioned factors, as well as the chlorophyll content, reached the highest values at the surface, whereas the highest COD was recorded at the bottom. As production prevailed over destruction in the surface layers decomposition of the waste substance took place in deeper layers, so that at the beginning of August the COD, turbidity, and oxidability curves were parallel, indicating that the mineralization of these waters was complete. A pronounced physico-chemical stratification, resulting from great turbidity and the colour of the water, is a characteristic feature of strongly eutrophic ponds (Uhlmann 1965, Wróbel 1965 a, Stahl, May 1967).

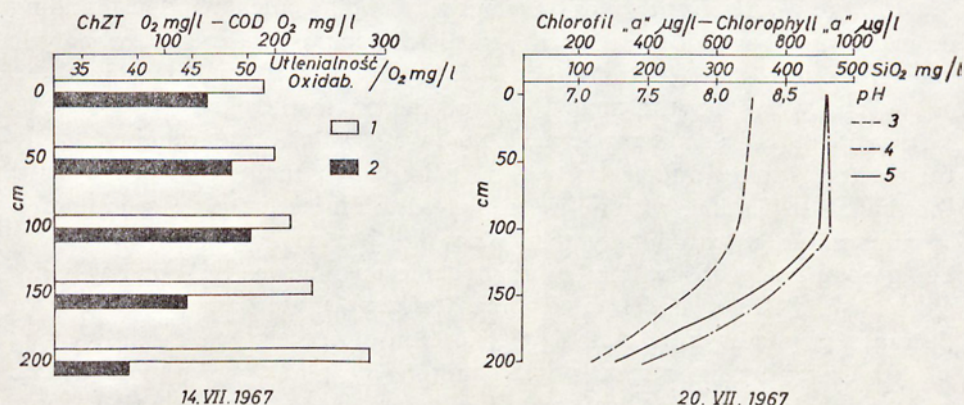

Ryc. 6. Uwarstwienie substancji organicznych, mętności, chlorofilu i odczynu wody w końcowej fazie mineralizacji ścieków w stawie Polny III. 1 — ChTZ; 2 — utlenialność; 3 — pH; 4 — mętność; 5 — chlorofil

Fig. 6. Stratification of organic matter, turbidity, chlorophyll and water reaction in the final phase of mineralization of wastes in the pond Polny III. 1 — COD; 2 — oxidability; 3 — pH; 4 — turbidity; 5 — chlorophyll

The long period of self-purification of wastes did not permit the stocking of this pond with carp, hence the purified waters were kept in this pond for another year. After completion of the mineralization process of wastes the content of organic matter in the water depended on the development of the phytoplankton and decomposing bottom sediments. A mass development of water fleas, characteristic of waste water ponds (Uhlmann 1965, Kryutchkova 1968), caused in August and September a filtering off of algae from the water and a decrease in turbidity with a simultaneously high oxidability caused by decomposition of plant and animal organisms. This state lasted till spring 1968 at which time the pond was stocked with carp. In 1968 the content of organic matter in the water varied, depending on the photosynthesis of algae, its magnitude being similar to that of organic substance in the water of minerally fertilized ponds.

During the period of anaerobic decomposition of the wastes, mineral nitrogen occurred only in the form of ammonium (fig. 7). For the two first months in the period of bacterial decomposition and small participation of plankton forms a small decrease in organic nitrogen was recorded, ammonium nitrogen remaining almost on the same level. In May and June a great biological sorption of ammonium nitrogen took place and organic nitrogen increased at an intensified development of *Euglenophyta* and *Volvocales* (Kyselowa 1973). In July and at the beginning of August, after the change from anaerobic to aerobic conditions, a considerable elimination of nitrogen took place as a result of the development of phytoplankton. Together with the occurrence of photosynthesizing organisms, two different zones developed: a trophogenic one where binding of mineral nitrogen by plankton organisms took place and a tropholytic one where nitrogen was liberated. Disintegration of remnants of plankton organisms, which have a small ratio of carbon to nitrogen (Stangenberg 1949, Serenkov, Pachonova 1960), influenced favourably the accumulation of mineral nitrogen in the water. In the case of intensive thermal stratification, with an incomplete diurnal circulation, accumulation of ammonium nitrogen may take place in the tropholytic layer (fig. 8), being completely absent in the trophogenic one. Since this pond was not stocked with fish a sudden development of zooplankton and a concomitant decrease in photosynthesis and deterioration of the oxygen condition took place. The filtering off of phytoplankton by plankton animals caused a decrease in the biological sorption of nitrogen; this caused some disturbance of the balance between nitrogen uptake by plants and its transition from the disintegrating sediments into the water. Thus, an increase in ammonium nitrogen concentration in the water to the magnitude of the first period of self-purification of the waste waters took place in winter. When the water temperature and the content of organic matter were low an increase in oxygen content took place in the surface layer (photosynthesis of the top layers under the ice cover); this made nitrification possible, in spite of great oxygen deficiency in the layers close to the bottom. From the time of intensification of the nitrification process a fall in mineral nitrogen in the water was observed. Losses of mineral nitrogen could be caused by biological sorption during assimilation of algae and denitrification in which nitrates were the basic hydrogen acceptor; losses of nitrogen in the form of  $N_2$  (Fewson, Nicholas 1961, Feuillade, Laurent 1969) are possible. Denitrification in the water layers at the bottom could in the winter months, i. e. January and February, be of greater importance than assimilation of nitrates in upper water layers. In March another intensification of photoplankton development, amelioration of oxygen conditions, and acceleration of nitrification processes took place. In the summer and autumn months the developing phytoplankton eliminated mineral nitrogen compounds, these being found

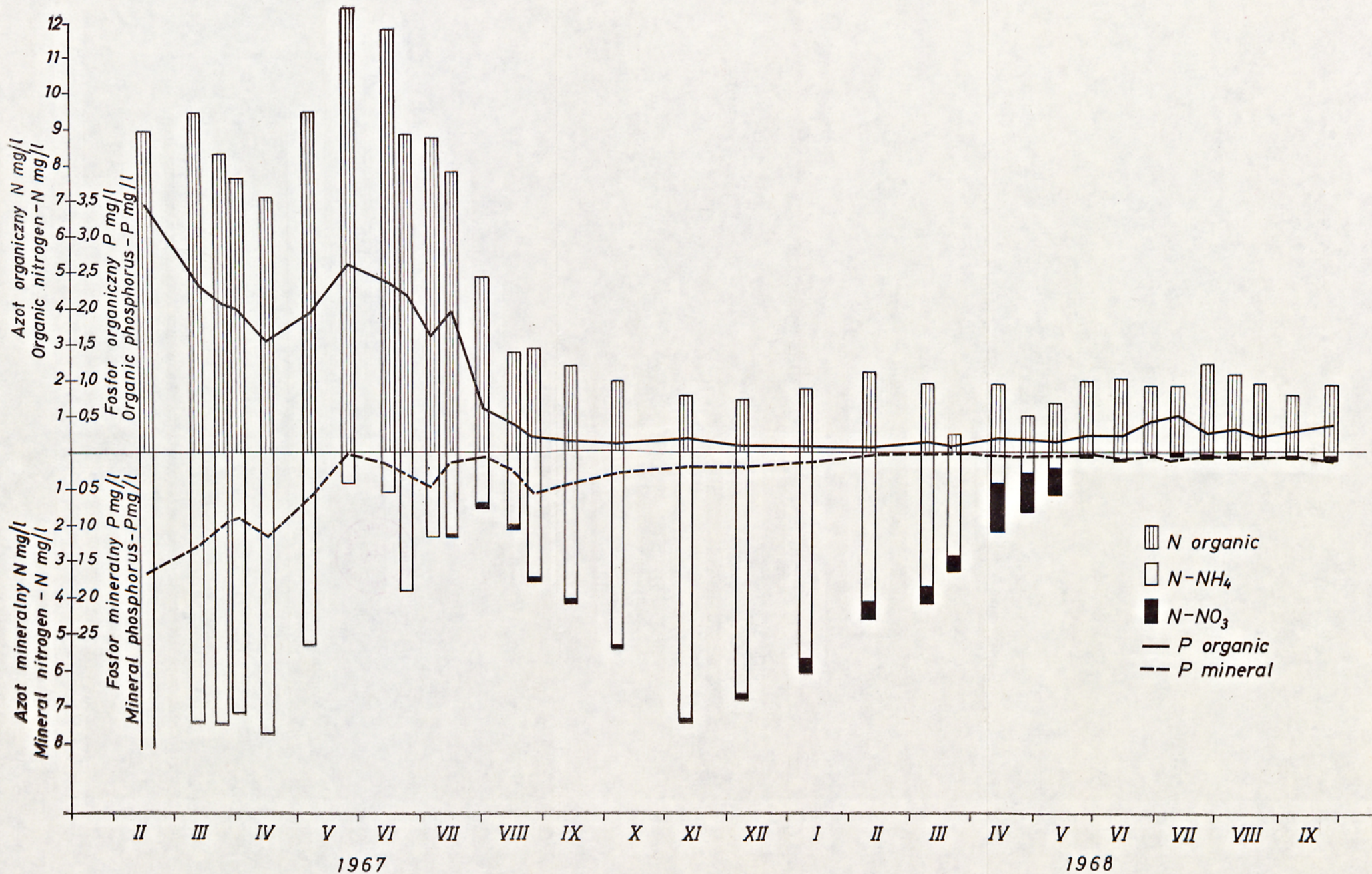

Ryc. 7. Azot i fosfor w wodzie stawu Polny III  
 Fig. 7. Nitrogen and phosphorus in the water of the pond Polny III

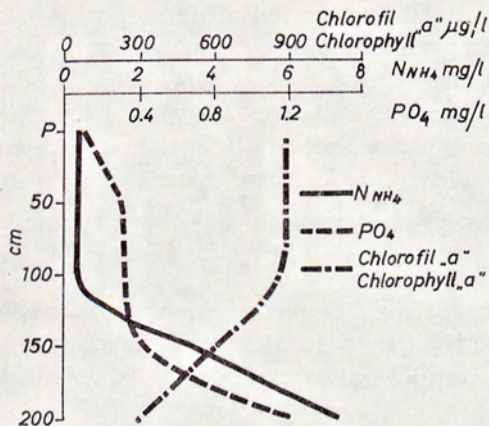

Ryc. 8. Zawartość mineralnych form azotu i fosforu w wodzie stawu Polny III w okresie wysokiej fotosyntezy fitoplanktonu (20.VII.1967)

Fig. 8. Mineral forms of nitrogen and phosphorus content in the water of the pond Polny III in the period of high photosynthesis of the phytoplankton (20.VII.1967)

at that time in trace amounts. Nitrogen was found in organic form and its amounts varied in dependence on the phytoplankton biomass.

In the period of anaerobic decomposition of wastes changes in the content of mineral and organic forms of phosphorus were similar to those of nitrogen (fig. 7). During intensive photosynthesis, when the anaerobic conditions changed into aerobic ones, elimination of organic and mineral compounds of phosphorus was highest. By the end of August and in September and increase in mineral forms of phosphorus occurred (with an oxygen content below  $0.5 \text{ mg O}_2/1$ ) after which till March, the phosphorus content in organic and mineral form decreased constantly, conversely to the high content of mineral nitrogen. When elimination of nitrogen from the water takes place mainly biologically, with phosphorus, as in the present case, physico-chemical sorption by sediments can be of considerable importance. Phosphorus could be absorbed from the water not only biologically but also by loamy minerals (Pasternak 1966) and precipitated in insoluble phosphoro-ferric compounds (Einsele 1938, Ohle 1938, Mortimer 1941/42). With an basic reaction a large part of the phosphorus can be precipitated from the wastes in the form of calcium phosphate (Fitzgerald, Rohlich 1964). After the pond had been stocked with fish in 1968 an increase in phosphorus, mainly in organic form, took place. This was connected with renewed development of phytoplankton.

In the first weeks after flooding the pond an increase in the reaction in the alkaline direction took place. This indicates favourably proceeding



disintegration processes of organic matter (fig. 9). The produced organic acids, characteristic of the first period of decomposition, become more and more stabilized during the methane fermentation, this being associated with an increase in pH (Chmielowski 1966).

Strong hardness and alkalinity of the wastes released into the ponds distinctly influenced the reaction of the water at the time of maximum photosynthesis. In minerally fertilized ponds the water often showed a reaction above pH 10 (Wróbel 1965a, Fereńska, Lewkiewicz 1966), this reaction often remaining at the same level for a long period of time.

In the pond Polny III no water reaction above pH 8.4 was recorded throughout the investigation period. During anaerobic decomposition the decrease in hardness and alkalinity proceeded slowly, with the exception

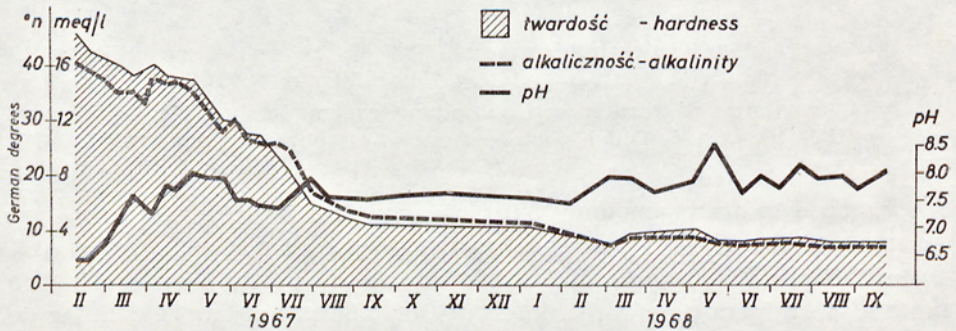

Ryc. 9. Odczyn, alkaliczność i twardość ogólna wody w stawie Polny III

Fig. 9. pH-value, alkalinity and total hardness of the water of the pond Polny III

of the first period following flooding of the ponds with wastes. A considerable decrease in hardness in the first period could have been caused by the establishing of a balance between the calcium and magnesium contents in the bottom layer and the water in the ponds (Brest 1925) and the dilution of the wastes due to thawing of the ice.

Analysis of the water showed a 50 times lower calcium and magnesium content in the ice than in the wastes under the ice cover of these ponds. The greatest decrease in hardness and alkalinity of polluted pond water was observed during the short transitory period between the anaerobic purification and the aerobic one. A mass development of photosynthesizing algae and increased free and bound  $\text{CO}_2$  uptake caused precipitation of calcium carbonate. After this stage alkalinity and hardness of the water in the pond varied only in a small range.

In the water of the ponds of Poland the sodium and potassium content varied within a wide range in dependence on the quality of the subsoil and inflow of polluted waters. For the most part the sodium content varied

from 4—12 mg/l and that of potassium from 4—8 mg/l (Stangenberga-Oporowska 1967 a, 1967 b, Pasternak 1966, 1967, Wróbel 1965 b). In the ponds of the Experimental Farms of the Polish Academy of Sciences the potassium content rarely exceeded 3 mg/l (Wróbel 1962, 1965b), with a slightly lower sodium content.

The content of sodium and potassium in the wastes released into the pond deviated greatly from the content of these elements in ponds not fertilized with wastes. After flooding the pond with wastes a rapid fall in the amount of these elements took place which could have been caused by dilution due to thawing of the ice cover (fig. 10). Unlike calcium, sodium

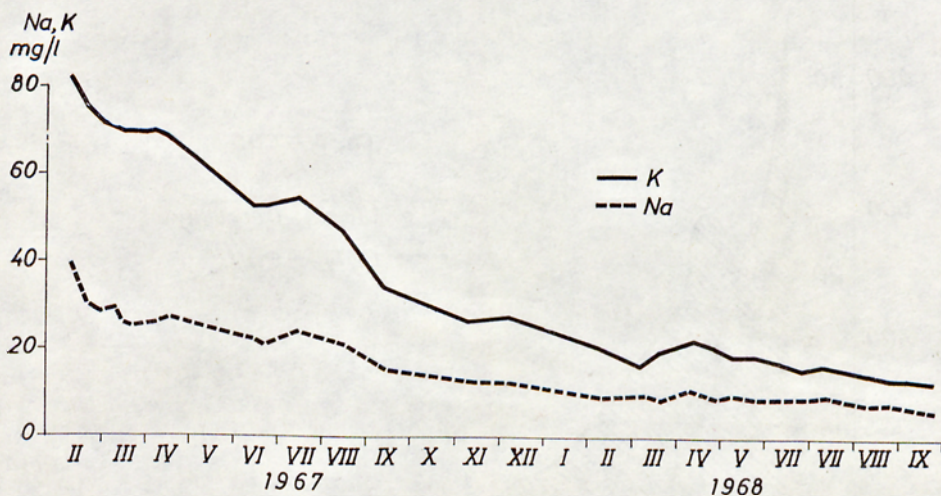

Ryc. 10. Zawartość sodu i potasu w wodzie stawu Polny III

Fig. 10. Sodium and potassium content in the water of the pond Polny III

and potassium did not show any dependence on the intensity of the biological processes. All the time the ponds were flooded a fall in the content of these elements in the water was observed. Greater variations in the sodium and potassium content were caused, among other factors, by changes in the water level in the ponds owing to evaporation and rainfall, as Stangenberga-Oporowska mentioned (1967 b). A great decrease in the content of these elements was observed between 12th May and 5th June when the water level, due to rainfall, was raised by about 10 cm and in the middle of August when the pond was additionally filled with river water.

In the pond Łąkowy the wastes contained a greater amount of organic and mineral matter than in the pond Polny III. A considerable fall in BOD<sub>5</sub> and COD in the first period of mineralization (sedimentation during winter stagnation) in the water of the pond Łąkowy was followed by a slight increase in the amount of organic matter (fig. 11) resulting from

turbulent currents in the pond and thawing of the ice cover. Between the 1st and 15th April the pond was brought to its full level by adding clean water. The small amount of river water introduced had no great influence on the decrease in the amount of organic matter in the pond. Oxidability of the water, similarly to that in the pond Polny III, amounted initially to only 5 per cent of the COD value. With self-purification of

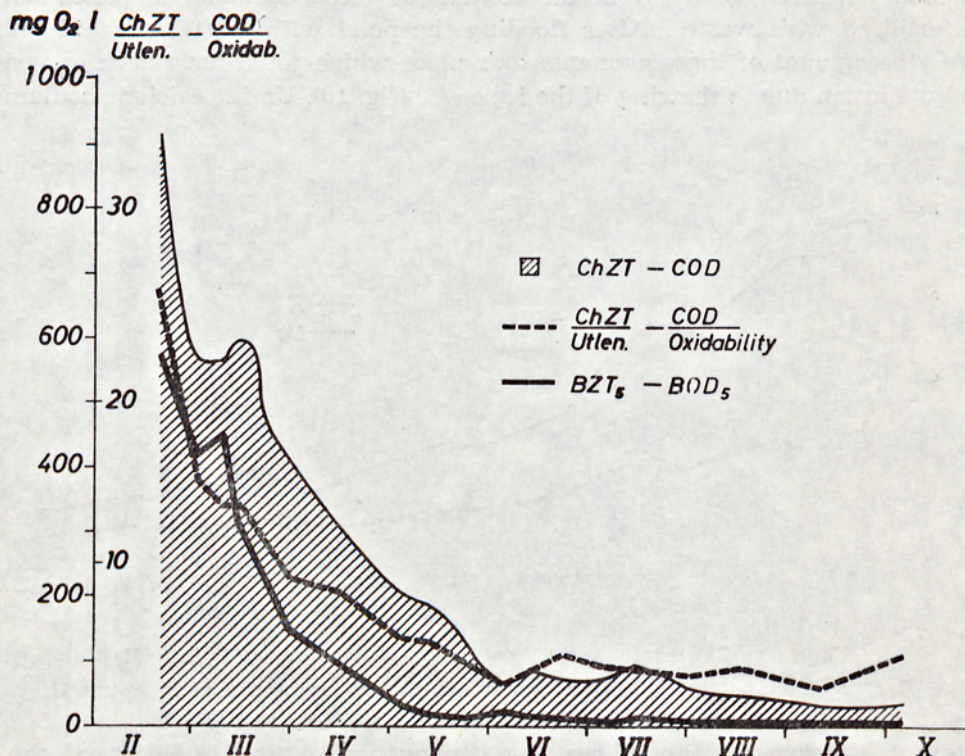

Ryc. 11. Chemiczne i biologiczne zapotrzebowanie tlenu w wodzie stawu Łąkowy w 1967 r.

Fig. 11. COD and BOD<sub>5</sub> in the water of the pond Łąkowy in 1967

the wastes their oxidability increased (fig. 12) and after transition from anaerobic to aerobic conditions (12th May) oxidability constituted 20 to 40 per cent of the COD, similar values being obtained in ponds into which no wastes were released (Wróbel 1962, Fereńska, Lewkowicz 1966, Lewkowicz, Wróbel 1971).

At the beginning of June the pond was stocked with carp and until it was fished the content of organic matter in the pond varied in dependence on the intensity of production of organic matter by the phytoplankton.

The decrease in the amount of organic matter in the pond Łąkowy, due to dilution of wastes, permitted reduction of the mineralization period

by more than 2 months in comparison with the pond Polny III. The great amount of lime applied to the bottom of Polny III had no great influence on the mineralization process, as was the case in investigations carried out in Byelorussia and the Ukraine (Sivko, Lachnovič 1967, Prosjanyj, Makina, Francuzova 1965).

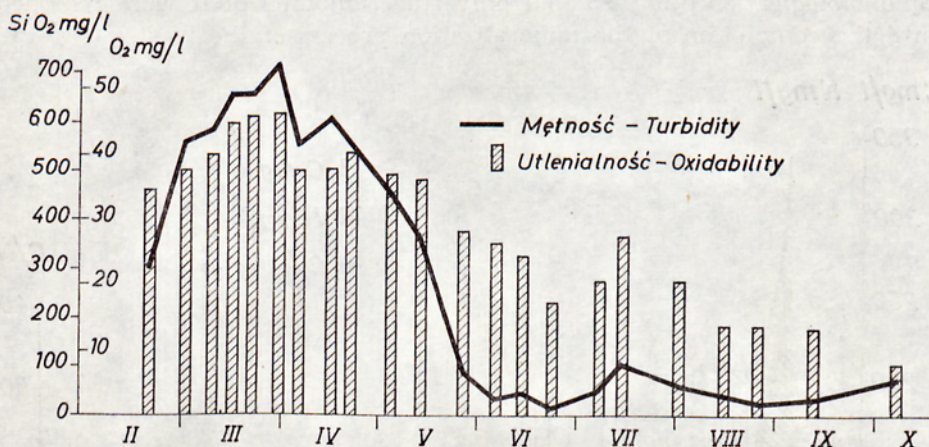

Ryc. 12. Mętność i utleniałość wody w stawie Łąkowy III w 1967 r.

Fig. 12. Turbidity and oxidability of the water of the pond Łąkowy in 1967

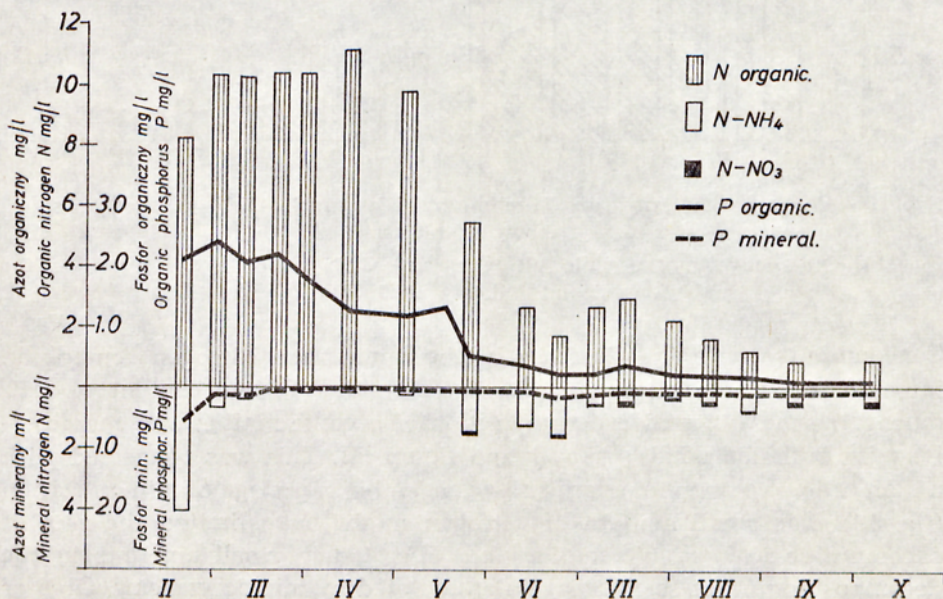

Ryc. 13. Azot i fosfor w wodzie stawu Łąkowy w 1967 r.

Fig. 13. Nitrogen and phosphorus in the water of the pond Łąkowy in 1967

The dynamics of the nitrogen content in the pond Łąkowy developed in a slightly different way from those in the pond Polny III. A lower content of organic matter in the wastes permitted a more rapid mineralization of the wastes, omitting the initial phase of first stage of weak development of plankton organisms (Kyselowa 1973). Already in the first months following flooding ammonium nitrogen underwent rapid biological sorption, so that only trace amounts of it were recorded until the completion of the mineralization process of the wastes (fig. 13).

Cmg/l Nmg/l

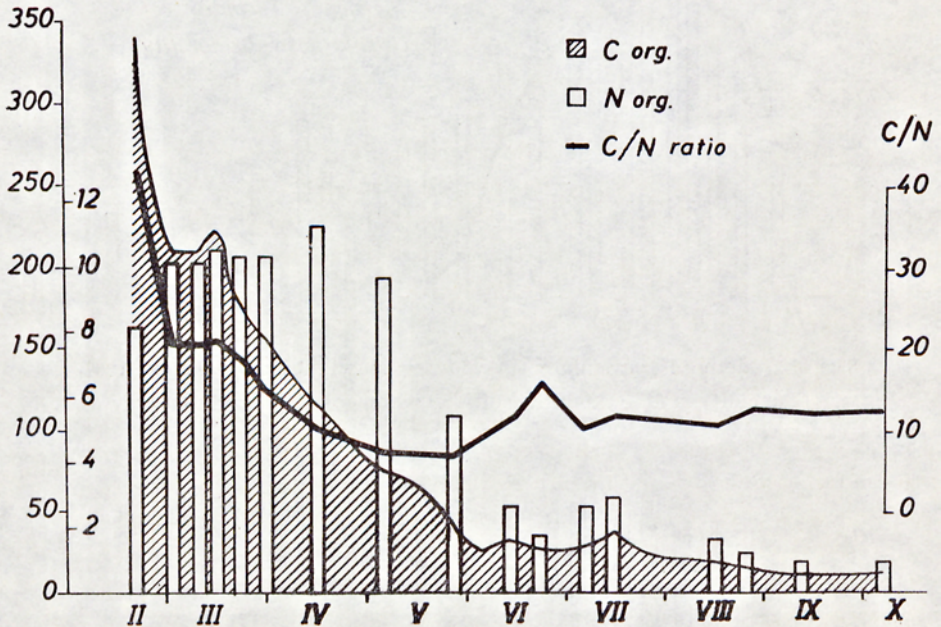

Ryc. 14. Węgiel organiczny, azot organiczny i stosunek C:N w wodzie stawu Łąkowy w 1967 r.

Fig. 14. Organic carbon, organic nitrogen, and C:N ratio in the water of the pond Łąkowy in 1967

Concomitantly with the decrease in the ammonium nitrogen content an increase in organic nitrogen content took place. A low content of  $\text{NH}_4$  during the most intensive decomposition of organic matter was characteristic for both the ponds Łąkowy and Polny III. This was connected with a high ratio of carbon to organic nitrogen in the first stage of mineralization (fig. 14). The small amount of nitrogen might have limited the rate of decomposition of organic matter and, liberated in small amounts in the decomposition processes, was again assimilated by microorganisms. Greater amounts of nitrogen were observed towards the end of the process of mineralization of the wastes in anaerobic conditions with a low ratio of

carbon to nitrogen. Losses in total nitrogen were at this time very small. From the moment the ponds were flooded with wastes till the time when dissolved oxygen appeared in the water (2.5 months) they amounted to 20 per cent.

The period of high photosynthesis of algae, at the end of May and beginning of June, when a considerable fall in the nitrogen content in the water was observed, was followed by another increase in ammonium nitrogen in conditions of high oxygen deficiency. After stocking the pond with carp an increase in photosynthesis of algae and a concomitant biological sorption of mineral nitrogen and a rise in the content of organic nitrogen were observed. Nitrate and nitrite nitrogen was also found in small amounts.

During the whole period of investigation the content of total phosphorus in the pond Łakowy showed a decreasing tendency (fig. 13) and changes in the content of organic and mineral phosphorus depended on the content of organic matter in the water. During increased photosynthesis of the phytoplankton the participation of organic phosphorus in the water increased, whereas with a higher rate of decomposition of organic matter the participation of mineral phosphorus increased.

Changes in the reaction and alkalinity of the water in the pond Łakowy proceeded similarly as in the pond Polny III (fig. 15). Only during the time of high photosynthesis of the phytoplankton did the water reaction attain the value pH 9.00, this being connected with a lower hardness of the water in this pond. A higher concentration of ferrum occurred only in the initial stage of self-purification of the wastes. The lowest ferrum content was observed during the period of high photosynthesis of the phytoplankton with an increase in the water reaction and a fairly high oxygen content. At the end of the season an increase in ferrum content in the water was again observed, this being connected with a fall in reaction and a low oxygen content in the water.

Changes in sodium and potassium content in the pond Łakowy were similar to those in the pond Polny III. A considerable fall in the content of these elements in the first half of April was caused by clean water released into the pond (fig. 16). Elimination of sodium and potassium did not proceed uniformly for each element; during this whole time a more rapid elimination of potassium than of sodium was observed.

In 1968 the pond Łakowy was filled with clean water from the River Bajerka. The content of organic matter and mineral compounds of phosphorus and nitrogen (Table V) did not differ from that in non-fertilized ponds of the Farm at Gołysz (Lewkowicz, Wróbel 1971). The greater amounts of nitrates found at the beginning of the season came from the waters of the River Bajerka. The oxygen content in the bottom layers was in 1968 equal to or even higher than in the layers (fig. 17); this indicates an oligotrophic character of the pond (Wróbel 1965 a).

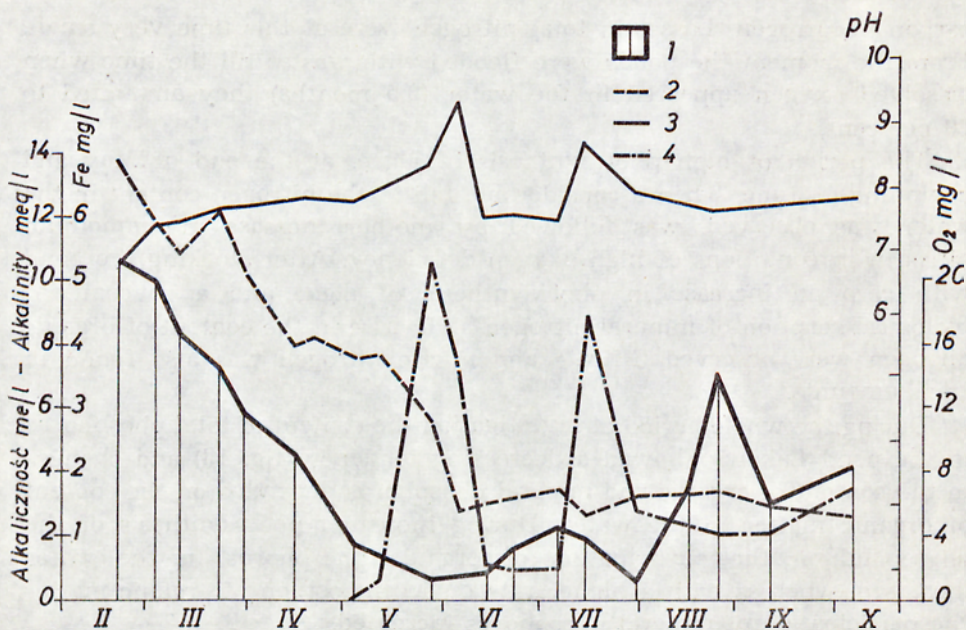

Ryc. 15. Odczyn wody, alkaliczność i zawartość żelaza w wodzie stawu Łąkowy w 1967 r. 1 — żelazo ogólne, 2 — alkaliczność, 3 — pH, 4 — tlen rozpuszczony

Fig. 15. pH-value, alkalinity, and iron content in the water of the pond Łąkowy in 1967. 1 — total iron; 2 — alkalinity; 3 — pH; 4 — dissolved oxygen

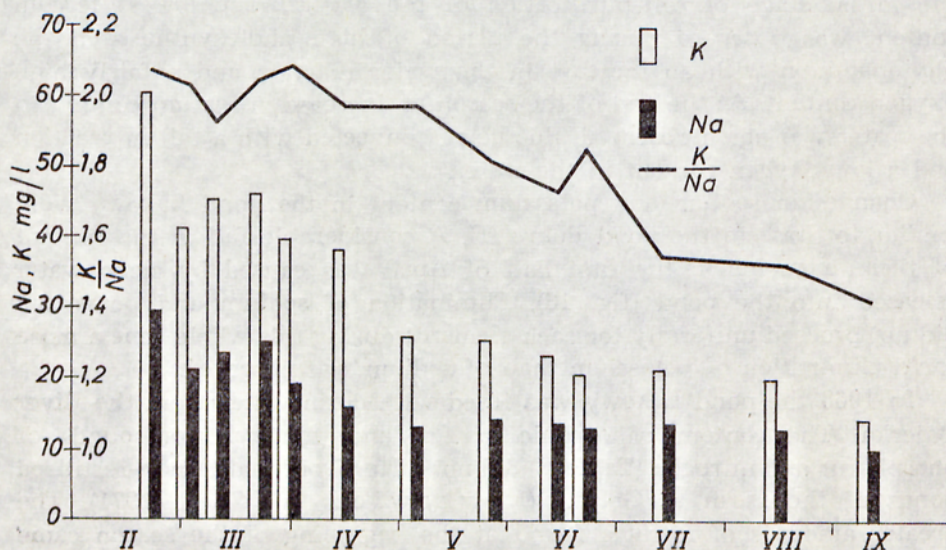

Ryc. 16. Zawartość sodu i potasu w wodzie stawu Łąkowy w 1967 r.

Fig. 16. Sodium and potassium content in the water of the pond Łąkowy in 1967

In 1968 experiments were carried out in two accumulation ponds Zimowy Wielki and Żabiniec in which wastes were diluted with pure water. During filling of the ponds with wastes clean water was added in proportions. The wastes in the pond Zimowy Wielki were diluted in such a way that the content of organic matter in the waters was about 1/4 higher than that in the pond Żabiniec. The pond with a higher content of organic matter was subjected to intensive liming in order to observe the influence of liming on the rate of mineralization of the organic matter.

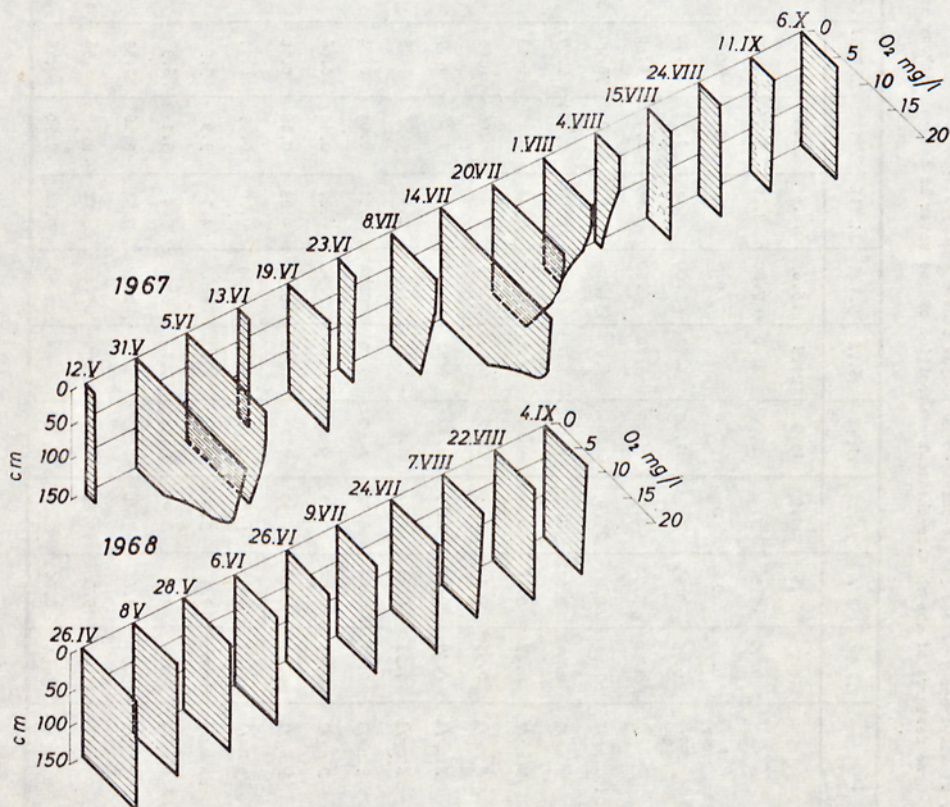

Ryc. 17. Zawartość tlenu w wodzie stawu Łąkowy w latach 1967 i 1968

Fig. 17. Oxygen content in the water of the pond Łąkowy in the years 1967 and 1968

Immediately after flooding the pond with wastes a considerable fall in the content of organic matter in the water was recorded (Table VI, VII) similarly as in the accumulation ponds in 1967. In order to accelerate the process of mineralization of the wastes in the pond Zimowy Wielki the pond was limed from the 2nd to the 5th May in the amount of 2.8 t CaO/ha. Liming was carried out in the final stage of mineralization with COD amounting to 360 mg/l. No influence of liming on the rate of mineralization of organic matter was observed and transition from anaerobic to aerobic



Tabela V. Niektóre cechy składu fizyko-chemicznego wody w stawie łąkowy w 1968 r.  
 Table V. Some features of the physico-chemical composition of the water in the pond łąkowy in 1968

Czynnik Factors	Data Date	26. IV	8. V	23. V	11. VI	26. VI	9. VII	24. VII	6. VIII	22. VIII	5. IX	24. IX
Temperatura Temperature	°C	18.0	15.6	11.9	15.3	21.8	25.6	18.6	21.5	18.2	19.8	13.8
pH		9.10	7.90	7.40	8.00	8.10	7.80	8.20	7.75	8.00	7.65	7.90
Alkaliczność węglanowa Phenolphthalein alkalinity	me/l	0.15	0	0	0	0	.0	0	0	0	0	0
Alkaliczność ogólna Total alkalinity	me/l	0.75	0.93	1.25	1.40	1.72	2.00	2.00	1.95	2.10	2.22	2.14
Twardość ogólna Total hardness	on °g	3.50	3.70	4.35	4.90	5.70	6.00	6.50	6.15	6.80	6.95	6.55
Mętność Turbidity	SiO <sub>2</sub> mg/l	32.5	80.0	27.0	64.0	66.0	131.5	62.0	80.0	58.0	31.0	380.0
Azotyny Nitrite nitrogen	N mg/l	0.018	0.012	0.007	0.004	0.003	0.004	0.004	0.004	0.003	0.004	0.008
Azot amonowy Nitrate nitrogen	N mg/l	0.47	0.16	0.035	0.06	0.12	0.065	0.13	0.11	0.13	0.13	0.14
Azot amonowy Ammonia nitrogen	N mg/l	0.35	0.10	0.05	0.12	0.05	0.05	0.05	0.05	0.05	0.06	0.15
Azot organiczny Organic nitrogen	N mg/l	0.49	0.67	0.65	1.42	0.93	1.07	2.19	1.49	1.07	0.78	1.39
Azot ogólny Total nitrogen	N mg/l	1.33	0.94	0.74	1.60	1.10	1.19	2.37	1.65	1.25	0.97	1.69
Fosfor mineralny Phosphate phosphorus	P mg/l	0.02	0.02	0.02	0.02	0.02	0.04	0.01	0.04	0.04	0.02	0.10
Fosfor organiczny Organic phosphorus	P mg/l	0.13	0.08	0.11	0.19	0.18	0.30	0.27	0.12	0.06	0.18	0.31
Fosfor ogólny Total phosphorus	P mg/l	0.15	0.10	0.13	0.21	0.20	0.34	0.28	0.16	0.10	0.20	0.41
Żelazo Iron	Fe mg/l	0.01	0.03	0.17	0.09	0.20	0.34	0.20	0.09	0.11	0.09	0.42
Sód Sodium	Na mg/l	4.0	4.1	3.9	4.0	4.8	4.6	4.3	3.9	3.9	3.6	3.7
Potas Potassium	K <sub>2</sub> O mg/l	4.0	4.6	5.0	5.2	5.1	5.8	5.4	5.1	6.3	6.2	6.3
Utlenialność Oxidability	O <sub>2</sub> mg/l	5.90	5.62	7.40	8.31	6.30	9.42	7.54	8.16	7.58	7.56	6.51
ChZT COD	O <sub>2</sub> mg/l	15.04	15.38	19.27	19.86	25.00	27.48	25.00	23.08	25.56	15.62	35.82
Tlen rozpuszczony Dissolved oxygen	O <sub>2</sub> mg/l	10.24	8.00	8.00	8.15	8.48	7.50	9.28	7.90	8.16	8.16	8.80



Tabela VI. Niektóre cechy składu fizyko-chemicznego wody w stawie Zimowy Wielki  
 Table VI. Some features of the physico-chemical composition of the water in the pond Zimowy Wielki

Czynnik/ Factor	18.I	8.II	7.III	20.III	30.III	11.IV	26.IV	8.V	23.V	11.VI	26.VI	9.VII	24.VII	6.VIII	22.VIII	5.IX	24.IX
Temperatura Temperature	2.8	2.1	2.7	3.9	10.7	5.2	17.6	15.3	11.3	14.2	22.7	26.1	19.5	21.4	18.2	20.1	14.2
pH	6.10	6.15	6.45	7.10	7.60	7.40	7.40	7.40	7.35	7.70	7.90	7.50	7.30	7.70	8.00	7.60	7.60
Alkalizność ogólna Total alkalinity	11.00	10.20	9.75	9.50	9.50	9.40	9.00	7.60	7.40	5.60	4.28	4.20	4.04	3.42	3.42	3.48	3.34
Twardość ogólna Total hardness	31.0	28.4	28.3	25.2	25.5	24.8	25.5	19.2	16.5	13.9	10.8	10.1	9.8	8.6	9.0	9.0	9.0
Mętność Turbidity	400	590	186	400	600	475	1050	620	688	260	170	76	58	58	170	48	13
Azotowy Nitrite nitrogen	Ślady Traces	Ślady Traces	Ślady Traces	Ślady Traces	Ślady Traces	Ślady Traces	Ślady Traces	Ślady Traces	Ślady Traces	Ślady Traces	Ślady Traces	0.004	0.003	0.010	0.055	0.012	0.024
Azotanowy Nitrate nitrogen	Ślady Traces	Ślady Traces	Ślady Traces	Ślady Traces	Ślady Traces	Ślady Traces	Ślady Traces	Ślady Traces	Ślady Traces	Ślady Traces	0.11	0.08	0.15	0.11	0.19	0.16	0.14
Azot amonowy Ammonia nitrogen	8.75	6.75	8.30	2.90	0.30	0.45	0.90	0.20	0.20	0.90	0.55	1.80	3.20	2.35	0.98	1.50	1.50
Azot organiczny Organic nitrogen	8.61	7.25	6.35	8.86	13.14	9.63	11.14	12.26	12.12	7.64	5.61	5.34	3.64	1.85	3.50	2.70	1.58
Azot ogólny Total nitrogen	17.36	14.00	14.65	11.76	13.48	10.08	12.14	12.46	12.32	8.54	6.27	7.22	5.90	4.31	4.73	4.37	3.24
Fosfor mineralny Phosphate phosphorus	1.89	1.76	1.70	0.62	0.20	0.33	0.06	0.06	0.04	0.06	0.03	0.41	0.57	0.11	0.04	0.10	0.12
Fosfor organiczny Organic phosphorus	1.37	0.75	0.95	1.73	3.22	1.69	2.09	1.90	1.96	0.97	0.67	0.44	0.18	0.33	0.29	0.29	0.37
Fosfor ogólny Total phosphorus	3.26	2.51	2.65	2.35	3.42	2.02	2.15	1.96	2.00	1.03	0.70	0.85	0.75	0.44	0.33	0.39	0.49
Żelazo Iron	6.20	6.50	9.13	7.50	3.00	7.70	2.96	2.15	2.85	1.32	1.12	2.10	2.84	0.67	0.31	0.70	0.31
Sód Sodium	18.0	15.7	20.0	12.0	16.0	12.8	14.0	14.0	13.5	13.5	12.8	12.8	11.2	10.0	9.5	8.8	7.5
Potas Potassium	105.0	87.8	78.0	72.0	75.0	69.5	71.5	63.5	62.5	58.5	53.0	51.0	43.2	35.2	33.0	30.2	28.5
Włóknistość Oxidability	58.0	47.2	36.9	39.5	57.7	53.3	52.2	54.6	55.3	52.2	30.5	27.0	18.6	17.6	17.1	15.8	10.8
ChZT COD	931.0	794.0	734.9	628.8	615.3	503.4	434.1	320.0	290.5	187.2	128.1	88.6	61.8	53.8	66.2	53.1	40.3
BZT5 BOD5	800	560	540	384	346	288	180	163	53	-	29.4	11.2	5.1	11.2	-	-	-
Tlen rozpuszczony Dissolved oxygen	0	0	0	0	0	0	0	0	0	4.48	7.31	2.51	1.17	6.51	10.51	5.71	5.71

Tabela VII. Niektóre cechy składu fizyko-chemicznego wody w stawie Żabiniec  
 Table VII. Some features of the physico-chemical composition of the water in the pond Żabiniec

Czynnik Factors	Data Date	18.I	8.II	7.III	20.III	30.III	11.IV	26.IV	8.V	23.V	11.VI	26.VI	9.VII	24.VII	6.VIII	22.VIII	5.IX	24.IX
Temperatura Temperature	°C	2.8	1.9	2.5	4.2	10.3	5.0	17.5	15.8	11.5	14.9	22.3	26.2	19.2	21.3	18.4	19.9	14.0
pH		6.1	6.2	6.6	7.2	7.8	7.6	7.65	7.8	7.35	7.3	7.7	7.6	7.7	7.6	7.8	7.6	7.8
Alkaliczność ogólna Total alkalinity	mg/l	9.80	8.00	8.10	7.25	7.56	7.25	7.50	4.84	4.00	3.48	3.48	3.42	3.02	2.74	2.90	2.88	2.82
Twardość ogólna Total hardness	on og	28.0	21.9	22.6	19.0	19.6	18.5	18.5	12.1	10.1	8.9	9.0	8.9	8.45	7.65	8.00	8.05	7.80
Miętność Turbidity	SI0 <sub>2</sub> mg/l	375	423	136	400	428	530	495	155	61.5	31	48	225	175	190	234	200	330
Azotyny Nitrite nitrogen	N mg/l	Ślady Traces	Ślady Traces	Ślady Traces	Ślady Traces	Ślady Traces	Ślady Traces	Ślady Traces	Ślady Traces	0.002	0.003	0.003	0.002	0.006	0.004	0.005	0.01	0.01
Azotany Nitrate nitrogen	N mg/l	Ślady Traces	Ślady Traces	Ślady Traces	Ślady Traces	Ślady Traces	Ślady Traces	0.14	0.14	0.08	0.11	0.08	0.08	0.15	0.11	0.13	0.12	0.15
Azot amonowy Ammonia nitrogen	N mg/l	7.00	5.00	4.1	0.7	0.2	0.5	0.9	0.2	0.2	1.05	1.90	0.10	0.10	0.10	0.06	0.06	0.15
Azot organiczny Organic nitrogen	N mg/l	9.24	5.27	8.45	8.63	7.64	7.34	8.34	4.98	2.46	2.03	1.32	2.98	2.56	2.42	2.18	1.78	2.09
Azot ogólny Total nitrogen	N mg/l	16.35	10.39	12.63	9.33	7.95	7.92	9.39	5.32	2.74	3.19	3.30	3.16	2.82	2.63	2.38	1.97	2.40
Fosfor mineralny Phosphate phosphorus	P mg/l	1.30	1.17	0.59	0.13	0.05	0.03	0.04	0.02	0.02	0.07	0.07	0.02	0.02	0.03	0.06	0.05	0.07
Fosfor organiczny Organic phosphorus	P mg/l	1.63	0.79	1.44	1.27	1.85	0.95	1.26	0.60	0.37	0.34	0.39	0.60	0.29	0.31	0.25	0.32	0.30
Fosfor ogólny Total phosphorus	P mg/l	2.93	1.96	2.03	1.40	1.90	0.98	1.30	0.62	0.39	0.41	0.46	0.62	0.31	0.34	0.31	0.37	0.37
Żelazo Iron	Fe mg/l	5.6	5.3	7.1	4.0	1.15	1.95	0.85	0.9	0.34	1.20	1.02	0.53	0.43	0.31	0.40	0.42	0.47
Sód Sodium	Na mg/l	17	12.3	16.5	11.0	12.7	13.2	12.2	12.0	10.0	9.5	10.25	10.5	10.25	8.50	8.75	7.25	6.75
Potas Potassium	K <sub>2</sub> O mg/l	101	74	65	58.5	60.0	55.5	58.0	50.0	48.0	40.0	30.75	30.75	33.50	24.50	23.75	23.00	22.25
Utlenialność Oxidability	O <sub>2</sub> mg/l	48.6	35.7	36.3	39.5	46.8	42.7	49.0	39.0	21.3	18.7	15.7	23.9	16.6	16.3	15.8	16.1	11.8
ChZT COD	O <sub>2</sub> mg/l	823	555	599	472	419	295	225	151	95	56.7	53.1	73.3	54.4	49.2	57.1	51.6	50.8
BZT <sub>5</sub> BOD <sub>5</sub>	O <sub>2</sub> mg/l	608	391	346	224	192	96	32	24	-	8.53	8.23	18.23	23.52	13.60	-	-	-
Tlen rozpuszczony Dissolved oxygen	O <sub>2</sub> mg/l	0	0	0	0	0	0	0.25	6.40	2.08	1.76	4.16	6.40	10.08	7.09	7.89	6.35	7.63

conditions took place 1 month after liming (fig. 18). In aerobic conditions a much greater concentration of mineral compounds, especially nitrogen and phosphorus content, was observed in the pond Zimowy Wielki than in the pond Żabiniec. Differences in the content of mineral compounds between these two ponds were caused by a lower degree of dilution of the wastes in the pond Zimowy Wielki as well as by the fact that autotrophic processes in the pond Żabiniec started much earlier, this permitting a better utilization of mineral compounds. In the pond Żabiniec an increased

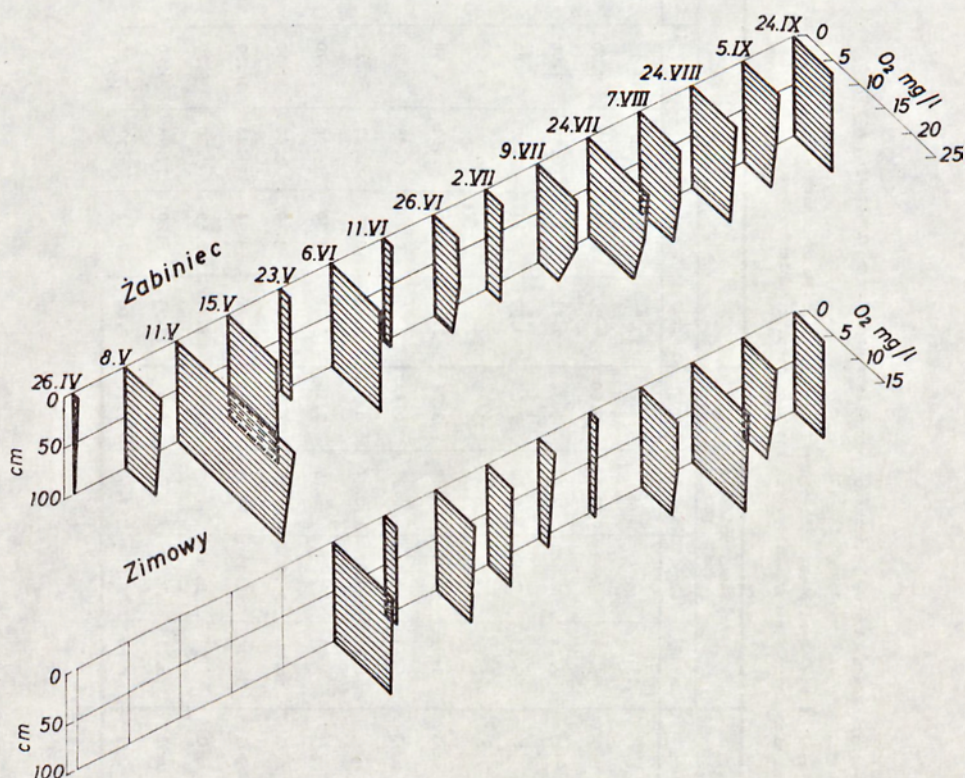

Ryc. 18. Zawartość tlenu w wodzie stawów Zimowy Wielki i Żabiniec

Fig. 18. Oxygen content in the water of the ponds Zimowy Wielki and Żabiniec

concentration of mineral forms of nitrogen and phosphorus was observed only during intensive decomposition of organic compounds in June. From July on a certain state of balance between synthesis and decomposition of organic matter in the pond was established, giving a low content of nutrient mineral substances in the water.

In the pond Zimowy Wielki a high concentration of mineral phosphorus and nitrogen was observed in July, this being connected with a preponderance of processes of decomposition of organic matter over its production with a mass development of *Daphnia magna*.

Tabela VIII. Niektóre cechy składu fizyko-chemicznego wody stawów używanych i nieużywanych łożyskami okorniczymi kompleksu stawowego "Maich"

Table VIII. Some features of the physico-chemical composition of the water of ponds fertilized and not fertilized with sugar factory wastes from the pond complex "Maich"

Czynnik Factors	Staw Pond	Stawy łożyskowe Waste ponds				Stawy bez łożysków Ponds without wastes				
		Łąkowy	Polny	Żabiniec	Zimowy	Kasprzycza	Gości	Leśny W.	Leśny IV	Leśny I
Temperatura Temperature	°C	13,8	14,0	14,0	14,2	13,9	14,2	13,9	14,1	14,4
pH		7,90	7,95	7,80	7,60	7,30	7,30	7,40	7,20	7,10
Alkalizność ogólna Total alkalinity	meq/l	2,14	2,54	2,82	3,34	1,11	0,80	0,80	1,08	0,83
Twardość ogólna Total hardness	°g	6,55	7,40	7,80	8,90	3,50	2,90	2,80	3,80	2,90
Mętność Turbidity	SiO <sub>2</sub> mg/l	380	340	320	13	124	10	300	10	8
Azot ogólny Total nitrogen	N mg/l	1,69	2,22	2,40	3,24	2,24	1,68	2,52	0,98	0,70
Fosfor ogólny Total phosphorus	P mg/l	0,41	0,46	0,37	0,49	0,55	0,20	0,49	0,28	0,16
Żelazo Iron	Fe mg/l	0,42	0,67	0,47	0,31	0,43	0,07	0,47	0,40	0,05
Sód Sodium	Na mg/l	3,70	6,50	6,75	7,50	4,20	4,70	4,90	5,70	6,40
Potas Potassium	K <sub>2</sub> O mg/l	6,30	15,50	22,25	28,50	4,00	4,10	4,60	4,10	3,40
Wapń Calcium	Ca mg/l	35,74	36,45	36,45	38,24	16,80	13,94	11,44	18,58	13,58
Magnez Magnesium	Mg mg/l	6,72	9,98	11,28	15,18	4,77	3,69	5,20	5,20	4,34
Utlenialność Oxidability	O <sub>2</sub> mg/l	6,51	8,06	11,78	8,99	13,33	6,20	17,98	6,20	3,72
Tlen rozpuszczony Dissolved oxygen	O <sub>2</sub> mg/l	8,80	8,56	7,63	5,71	8,00	7,04	9,12	7,04	8,32

Nitrates and nitrites occurred in small amounts and only towards the end of the vegetative season was an increase in the content of these compounds observed in the pond Zimowy Wielki.

The course of changes in alkalinity, hardness, and content of sodium and potassium was similar to that observed in 1967.

Before emptying the ponds in September 1968 an analysis of the water in the ponds of this complex fertilized and not fertilized with beet sugar factory wastes (Table VIII) was carried out. The influence of the wastes was reflected in the increase in pH of the water, alkalinity, and hardness, as well as in the sodium and potassium content.

### Primary production of phytoplankton

In 1967 phytoplankton production was measured only in the pond Łąkowy (fig. 19). In the pond Polny III the applied method of measuring primary production was unsuccessful because of a very low oxygen content in the water. In the pond Łąkowy the magnitude of primary production could not be established in the initial stage of mass production of the

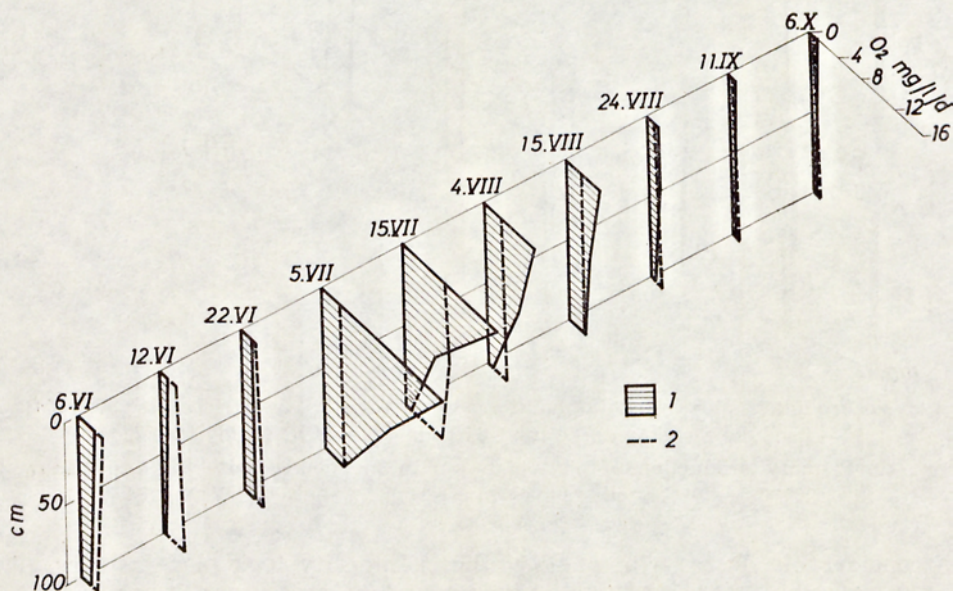

Ryc. 19. Produkcja pierwotna fitoplanktonu w stawie Łąkowy w 1967 r. 1 — produkcja całkowita O<sub>2</sub> mg/1/24 godz.; 2 — biologiczne zapotrzebowanie tlenu O<sub>2</sub> mg/1/24 godz.

Fig. 19. Primary production of phytoplankton in the pond Łąkowy in 1967. 1 — total production O<sub>2</sub> mg/1/24 h; 2 — BOC O<sub>2</sub> mg/1/24 h.

phytoplankton, but judging from the oxygen content in the water it must have been very high. In June a fall in production appeared, caused by a mass decay of phytoplankton, and for some weeks decomposition of organic matter prevailed over synthesis. In July another mass development of phytoplankton was recorded. Photosynthesis amounted, at that time, to 18 mg O<sub>2</sub>/l/d in the top layers of the water. In the autumn months

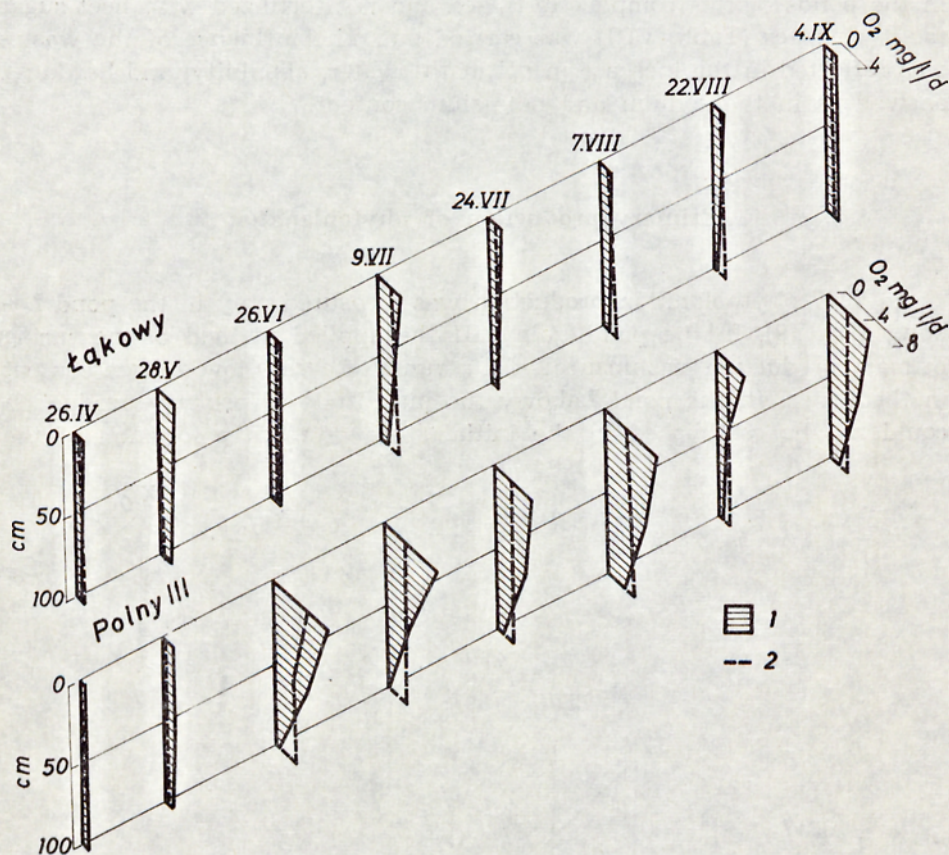

Ryc. 20. Produkcja pierwotna fitoplanktonu w stawach Polny III i Łąkowy w 1968 r. 1 — produkcja całkowita O<sub>2</sub> mg/1/24 godz.; 2 — BOC O<sub>2</sub> mg/1/24 godz.

Fig. 20. Primary production of phytoplankton in the ponds Polny III and Łąkowy in 1968. 1 — total production O<sub>2</sub> mg/1/24 h.; 2 — BOC O<sub>2</sub> mg/1/24 h.

a considerable decrease in photosynthesis intensity took place as a result of the limiting effect of physical factors, mainly light and chemical ones, i.e. nutrient salts.

In 1968 primary production was measured in 4 ponds. In the pond Łąkowy the primary production was very low all the time and did not exceed 4 mg O<sub>2</sub>/l/d (fig. 20). Its magnitude was similar to that in non-fertilized ponds (Lewkowicz, Wróbel 1971). Due to low turbidity

of the water no great differences between photosynthesis in the top and bottom layers of the water were observed. The rate of primary production in the pond Łąkowy indicated small influence of the wastes on the development of phytoplankton in the second year of exploitation of the ponds. In the pond Polny III intensity of photosynthesis formed differently. A high content of mineral compounds caused intensive

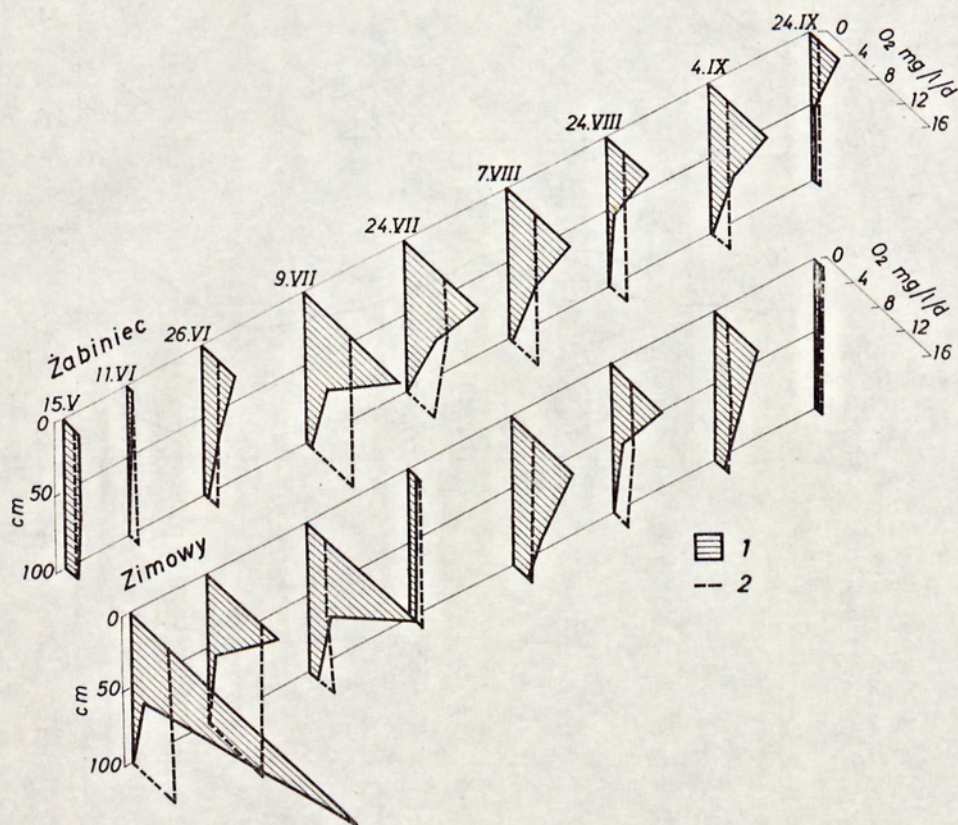

Ryc. 21. Produkcja pierwotna fitoplanktonu w stawach Żabiniec i Zimowy Wielki. 1 — produkcja całkowita  $O_2$  mg/1/24 godz.; 2 — biologiczne zapotrzebowanie tlenu  $O_2$  mg/1/24 godz.

Fig. 21. Primary production of phytoplankton in the ponds Żabiniec and Zimowy Wielki. 1 — total production  $O_2$  mg/1/24 h.; 2 — BOC  $O_2$  mg/1/24 h.

development of phytoplankton in this pond in 1968. After the pond was stocked with carp a great elimination of zooplankton took place; this, in turn, contributed to the intensification of photosynthetic processes. From June till the end of the vegetation season photosynthesis developed on the level of strongly eutrophic, minerally fertilized ponds with distinctly differentiated trophogenic and tropholytic layers.



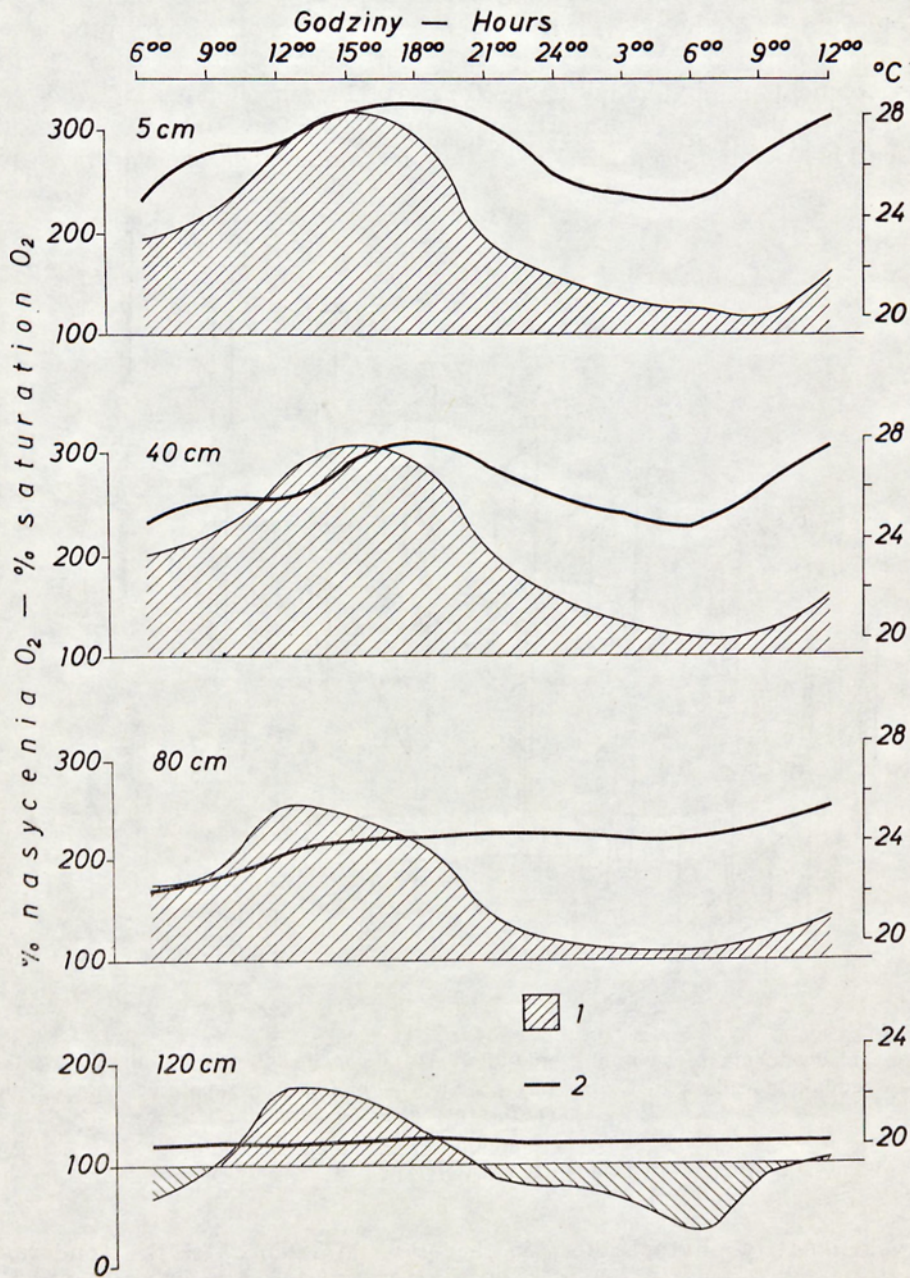

Ryc. 22. Zmiany dobowe zawartości tlenu w wodzie stawu Zimowy Wielki. 1 — procent nasycenia  $O_2$ ; 2 — temperatura

Fig. 22. Daily changes of oxygen content in the water of the pond Zimowy Wielki. 1 — percentage of saturation  $O_2$ ; 2 — Temperature

In the ponds Żabiniec and Zimowy Wielki, purifying the 1967/68 sugar campaign wastes, photosynthesis of algae was higher than that in ponds filled with wastes in the previous year (fig. 21).

In the pond Żabiniec, due to a higher dilution of the wastes autotrophic processes started at an earlier date than in the pond Zimowy Wielki. Photosynthesis of algae, however, was not measured in the initial period; it must, however, have been high because of the high degree of saturation of the water with oxygen (fig. 18). Measurements of primary production started on 15th May at the time of increased decomposition of organic matter with a low primary production. A new development of phytoplankton appeared in June and lasted till the end of the vegetation season. This resulted in primary production being on the level of highly eutrophicated ponds.

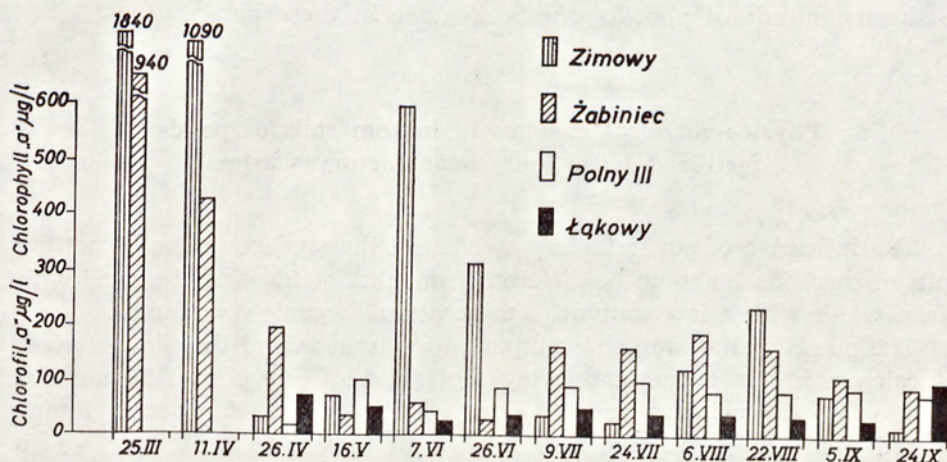

Ryc. 23. Zawartość chlorofilu w wodzie stawów w 1968 r.

Fig. 23. Chlorophyll content in the water of the ponds in 1968

The pond Zimowy Wielki was characterized by the greatest variations in intensity of phytoplankton photosynthesis. In this pond the initial period of intensive photosynthesis of the phytoplankton was observed in which the primary production in the top layers exceeded 30 mg O<sub>2</sub>/l/d. About the middle of July a considerable fall in photosynthesis caused by a mass development of *Daphnia magna* occurred. In the subsequent period the magnitude of the primary production was similar to that in the pond Żabiniec.

In all the investigated ponds transition from anaerobic to aerobic conditions was always connected with a very high photosynthesis of the phytoplankton. The initial supersaturation with oxygen was followed by a sudden fall in oxygen content connected with a rapid decay of phytoplankton. The course of changes in the intensity of photosynthesis of

phytoplankton in this period is illustrated by investigations on the daily content of oxygen carried out in the pond Zimowy Wielki (fig. 22). In spite of similar weather conditions a much smaller oxygen amount was found on the second day than in the analogous period on the previous day. Three days after completion of the investigations the oxygen content in the pond fell at all water levels below 50 per cent saturation.

Systematic investigations on the chlorophyll content in the ponds were carried out only in 1968. The highest chlorophyll content was recorded in the ponds Żabiniec and Zimowy Wielki in anaerobic conditions connected with a sudden development of *Volvocales* and *Euglenophyceae* (fig. 23). The role of these algae in the self-purification process of wastes has not been fully elucidated because of their mixotrophic character. In the aerobic period the chlorophyll content in the water was proportional to the magnitude of photosynthesis of algae in these ponds.

### Physico-chemical changes in bottom soils of ponds fertilized with beet sugar factory wastes

The influence of sugar factory wastes on the surface layers of bottom soils of carp ponds should be different from that of flooding the pond with clean water with a low content of mineral and organic compounds.

The ponds of the „Mnich” complex are characterized by a low content of calcium in the accumulative layer of the bottom soil and by an acid reaction of the primary rock (Pasternak 1959, 1965). Hence, liming caused a much greater increase in fish in these ponds (Starmach 1958).

Before fertilization with sugar factory wastes the soil of the examined ponds showed an acid reaction and high hydrolytic acidity with a low degree of saturation of the sorption complex with bases (Tables IX—XI). Differences occurring between the investigated ponds were caused by differences in the amounts of lime applied in these ponds in previous years and sometimes also by their utilization. In ponds of this type flooded with water poor in electrolytes a fairly intensive washing out of mineral compounds takes place (Wróbel 1959, Pasternak 1958). Polny III and Łakowy were relatively young ponds exploited for 3—4 years, whereas the pond Zimowy Wielki had been reconstructed. The oldest of these ponds Żabiniec showed the lowest pH value of the soil, especially in the shallow part, and the lowest degree of saturation with bases. In the deeper part of the pond Zimowy Wielki sediments showed a neutral reaction and a low content of calcium carbonate, this being caused by intensive liming of the pond in previous years.

A higher ratio of carbon to nitrogen occurred in the ponds exploited for

Tabela IX. Właściwości fizyko-chemiczne osadów w stawie Polny III  
 Table IX. Physico-chemical properties of sediments in the pond Polny III

Stanowisko Sampling point	Część Wpływna Shallower part of pond						Część głębsza Deeper part of pond					
	0 - 1 om		0 - 10 om		0 - 10 om		0 - 1 om		0 - 10 om		0 - 10 om	
	1966	1967	1968	1966	1967	1968	1966	1967	1968	1966	1967	1968
Poziom Layer												
Rok Year	1966	1967	1968	1966	1967	1968	1966	1967	1968	1966	1967	1968
pH	6.00	7.35	7.35	6.00	7.10	7.10	6.25	7.35	7.30	5.95	7.00	7.15
Kwasowość, hydrolityczna Hydrolytic acidity meq/100g gleby meq/100g of soils	3.86	0.93	0.74	3.94	2.08	1.64	3.15	1.07	0.74	3.29	2.15	1.34
Suma zasad wymienialnych Total exchangeable bases meq/100g gleby meq/100g of soils	7.64	14.00	16.40	6.88	9.53	11.59	8.98	15.80	16.80	7.64	9.33	10.78
Pojemność sorpcyjna Korpcion capacity meq/100g gleby meq/100g of soils	11.50	14.93	17.14	10.82	11.61	13.23	12.13	16.87	17.54	10.93	11.48	12.08
Stopień nasycenia zasadami Degree of base saturation %	66.43	93.77	95.79	63.59	82.09	87.60	74.03	93.66	95.78	69.90	81.28	89.24
CaCO <sub>3</sub> %	0.00	3.14	2.44	0.00	0.44	0.80	0.00	2.15	1.76	0.00	0.14	0.30
Węgiel organiczny Organic carbon %	1.875	2.468	1.560	1.573	1.521	1.502	1.406	1.918	1.904	1.088	1.004	1.100
Azot organiczny Organic nitrogen %	0.209	0.252	0.171	0.165	0.148	0.141	0.168	0.220	0.205	0.120	0.106	0.134
C : N	8.97	9.79	9.12	9.53	10.28	10.65	8.37	8.72	9.29	9.07	9.47	8.21

a longer time, this being mainly connected with the origin of the organic matter. Organic matter originating from higher plants shows a higher ratio of carbon to nitrogen than that originating from phytoplankton (Stangenberg 1949).

Liming the wastes in the ponds Zimowy Wielki and Polny III and liming the bottom of the pond Łakowy immediately before flooding makes it difficult to draw any conclusions as to the influence of a high content of calcium in the waste waters on the bottom sediments. Only in the pond Żabiniec was liming not applied; Łakowy was treated with only small amounts of lime, and moreover, only on one half of the pond (the shallow one). Increase in the sediment reaction, changes in hydrolytic acidity, and increase in the total bases in the pond Żabiniec and in both parts of the pond Łakowy indicate a great influence of the wastes themselves. In the pond Polny III, the most intensively treated with lime, the content of calcium in the waters (calculated from hardness) equalled the amount of calcium introduced during liming. In the pond Polny III, which was not emptied for a period of two years, a higher saturation of the soil with bases and lower hydrolytic acidity were observed in the second year than in the first one.

In the pond Łakowy, also observed for two years, the development of bottom soil properties under the influence of wastes was different from that in the pond Polny III, a certain effect being exerted by letting out the water after the first year of exploitation and refilling with clean water in the second year. In the first year the difference between these two ponds was only in the amount of calcium carbonate deposited on the bottom, this being caused both by the lower hardness of diluted wastes in the pond Łakowy and the smaller amount of lime used for liming this pond. In the second year of exploitation the reaction and hydrolytic acidity did not show any serious changes in the top layer of the bottom due to the presence of carbonates; the sum of exchangeable bases on the other hand, decreased considerably, this being caused by a decrease in the sorption capacity of the sediment.

In the pond Zimowy Wielki the effect of wastes and liming on the bottom sediments was in the first year of exploitation similar to that in the ponds Łakowy and Polny III. In the deeper part of this pond the influence of wastes and lime was small, this being connected with a high content of carbonates originating from intensive liming of the pond in the previous years.

The pond Żabiniec seemed interesting because no liming was applied there. Although the reaction of sediments was not increased to neutral, a fairly great increase of the reaction indicates a great influence of the wastes themselves on the bottom sediments. The greatest influence was observed in the top layer of the shallow part of the pond. The sediments of this pond demonstrated the highest acidity and required larger amounts

Tabela X. Właściwości fizyko-chemiczne osadów w stawie Łąkowy  
 Table X. Physico-chemical properties of sediments in the pond Łąkowy

Stanowisko Sampling point	Część wypływna Shallower part of pond						Część głębsza Deeper part of pond					
	0 - 1 om			0 - 10 om			0 - 1 om			0 - 10 om		
	1966	1967	1968	1966	1967	1968	1966	1967	1968	1966	1967	1968
Rok Year												
pH	6.55	7.25	7.10	6.35	7.05	6.80	6.55	7.30	7.05	6.45	7.15	6.55
Kwasowość hydrolityczna Hydrolytic acidity meq/100g gleby meq/100g of soils	2.86	1.00	1.12	3.44	2.29	2.46	2.22	0.93	0.97	2.72	1.65	1.94
Suma zasad wymiennych Total exchangeable bases meq/100g gleby meq/100 g of soils	11.80	15.98	11.14	10.20	13.61	10.80	10.69	13.52	10.18	9.63	12.81	10.72
Pojemność sorpcyjna Sorbtion capacity meq/100g gleby meq/100g of soils	14.66	16.98	12.26	13.64	15.90	13.26	13.11	14.45	11.15	12.35	14.46	12.66
Stopień nasyceńia zasadami Degree of base saturation %	80.49	94.11	90.88	74.79	85.60	81.45	83.07	93.58	91.30	77.98	88.60	84.68
CaCO <sub>3</sub> %	0.07	0.58	0.49	0.02	0.15	0.22	0.00	0.56	0.29	0.02	0.10	0.08
Węgiel organiczny Organic carbon %	2.365	2.435	2.282	2.070	2.136	1.714	1.750	1.786	1.788	1.491	1.701	1.535
Azot organiczny Organic nitrogen %	0.225	0.242	0.206	0.187	0.189	0.151	0.183	0.189	0.168	0.141	0.146	0.134
C : N	10.51	10.06	11.08	11.07	11.30	11.35	9.56	9.45	10.64	10.57	11.65	11.46

Tabela XI. Właściwości fizyko-chemiczne osadów w stawach Zimowy Wielki i Żabinięc  
 Table XI. Physico-chemical properties of sediments in the ponds Zimowy Wielki and Żabinięc

Staw Pond	Zimowy Wielki						Żabinięc					
	Część wylżycona Shallower part of pond			Część głębsza Deeper part of pond			Część wylżycona Shallower part of pond			Część głębsza Deeper part of pond		
	0-1 cm	0-10 cm	1967	0-1 cm	0-10 cm	1967	0-1 cm	0-10 cm	1967	0-1 cm	0-10 cm	1967
Stanowisko Sampling point												
Poziom Layer												
Rok Year												
pH	5.30	7.05	1968	7.00	7.35	1968	4.95	6.45	1968	6.10	7.05	1968
Kwasowość hydrolytyczna Hydrolytic acidity	meq/100g	5.15	1967	1.50	0.52	1967	6.58	2.60	1967	5.90	7.05	1967
Suma zasad wymiennych Total exchangeable bases	me/100g	5.44	1968	13.07	15.00	1968	5.51	3.57	1968	2.58	1.26	1968
Pojemność sorpcyjna Sorption capacity	meq/100g	8.60	1967	14.57	15.52	1967	18.47	26.80	1967	11.00	12.70	1967
Stopień nasycenia zasadami Degree of base saturation	%	61.25	1968	89.70	96.65	1968	64.37	90.30	1968	86.10	81.01	1968
CaCO <sub>3</sub>	%	0.80	1967	0.32	1.68	1967	0.00	0.08	1967	0.00	0.08	1967
Węgiel organiczny Organic carbon	%	4.963	1968	1.763	2.150	1968	5.538	6.117	1968	3.010	1.860	1968
Azot organiczny Organic nitrogen	%	0.349	1967	0.161	0.203	1967	0.442	0.505	1967	0.252	0.165	1967
C : N		11.83	1968	10.95	10.59	1968	12.52	12.10	1968	13.11	11.31	1968

of lime than that supplied with the wastes. It should be stressed, moreover that the dilution of wastes was highest in this pond. In the top layer of the bottom small amounts of carbonates, absent before the pond was filled with wastes, were observed.

The influence of wastes on the content of organic matter and nitrogen in the bottom soil was not so pronounced as on changes in the reaction and the investigated factors of the sorption complex. Although the content of organic matter, especially in the top layer of the bottom, increased in comparison with that before liming, these changes were not great. In the bottom soil of the ponds Łąkowy and Polny III a fall in organic matter in comparison with the state before fertilizing was observed in the second year of exploitation. The relation of carbon to nitrogen did not show any great variations, this indicating a high degree of mineralization of these wastes.

### Influence of fertilization with waste waters on increase in fish in ponds

In 1967 only the pond Łąkowy (Table XII) was stocked with fish. The pond Polny III, because of a long mineralization period of the wastes, was fully stocked with carp only in spring 1968. In autumn 1967 only 1000 carp fry were experimentally released into it. During the catch the carp in the pond Łąkowy were found to be in good condition and certain reserves of unconsumed benthos (Zięba 1973) were found in the bottom layer. The stock of 500 carp per 1 ha proved to be too small.

Tabela XII. Obsada i odłów ryb w akumulacyjnych stawach ściekowych  
Table XII. Stock and catch of fish in accumulation waste ponds

Staw Pond	Powierzchnia Area ha	Termin obsady Time of stocking	Obsada Stocking rate		Termin odłozu Time of fishing	Odłów Yield		Produkcja ryb Fish production kg/ha	Ubytki Mortality %
			sztuki specimens	kg		sztuki specimens	kg		
Polny III	9.0	8.XI.67 23.IV.68	1000	180	30.IX.68	420	340	390	58
			31500	1300		20550	4110		34.7
Łąkowy 1967	8.1	12.VI.67	4100	322	27.X.67	2880	2290	254	43.9
Żabiniec	10.0	6.VI.68	35000	2234	11.X.68	31800	6630	490	9.1



In 1968 the ponds Polny III and Żabiniec were very densely stocked. The pond Zimowy Wielki was treated as a pond to be stocked with transfer carp because of a delayed mineralization period of the wastes. The dense population of fish in the ponds Polny III and Żabiniec permitted a better increase in fish to be obtained than in the previous year. During the catch it was found that the carp were in poor condition and emaciated as a result of the low content of natural food in these ponds in the second half of the season (Kyselowa 1973, Zięba 1973). A stock of 3500 specimens of fish per 1 ha, with no supplementary feeding, is too high for accumulation ponds. These should be stocked with a smaller number of fish or when stocked more numerous, the fish should be supplementarily fed in the second half of the season.

During the catch of transfer carp in the pond Zimowy Wielki, the oxygen conditions, due to mass development of *Daphnia magna*, were unfavourable. The fish intended for stocking this pond were first released into the pond Zimowy Mały, stocked with fry, and then the dam between these two ponds was broken in two places. This operation, however, did not give the expected results and during the catch great losses in fish were observed in both ponds. The obtained results in increment of fish are in agreement with those obtained in Czechoslovakia and in the Soviet Union in ponds fertilized with sugar factory wastes. The increase in fish in the ponds Polny III and Żabiniec was greater than those obtained in the ponds of this complex fertilized with mineral fertilizers. The pond Łukowy was stocked in 1968 with carp in the amount of 2500 specimens ( $K_1$ )/ha, the fish being supplementarily fed. The natural increment amounted to 164 kg/ha, i.e. twice that in the control pond of this complex stocked with 300 specimens/ha, not fertilized and not supplementarily fed. Considering, however, the increase in eutrophy of the pond under the influence of feeding and the large fish population (Fereńska, Lewkiewicz 1966), it should be stated that the influence of the consequent effect of wastes on the increase in fish in the second year of exploitation of the pond was negligible.

## Results

In the works carried out on the utilization in fish ponds municipal sewage and that from the food and agricultural industries the importance of this method should be stressed because of its degree of purification of wastes, the economic effects from fish production being considered as less important. Investigations on the self-purification processes of sewage in fish ponds is of great importance also in elucidating the eutrophication process of rivers and lakes. Individual stages of self-purification in ponds

proceed similarly as in the rivers, the difference being only in the fact that self-purification in a river takes place over certain distance and in ponds in a certain time period (Sladeczek et al. 1958).

In the investigated waste ponds a low content of organic matter was observed during the time the ponds were emptied, this content being on the level of ponds not fertilized with wastes. A very small accumulation of this matter in the bottom sediments was also recorded. The low content of organic matter in the water and bottom sediments indicates full mineralization of sugar factory wastes in fish ponds.

In sewage treatment plants a high degree of purification from organic matter but only a relatively low reduction of mineral compounds can be obtained (Parker 1962, Rohlich 1963, Oswald et al. 1963, Whurmann 1964). Nitrogen and phosphorus are carried away from the treatment plant in the form of salts dissolved in the water and in organic compounds present in the cells of algae and bacteria. The high content of these compounds eliminated from the treatment plant contributes to excessive eutrophication of rivers and lakes. In fish ponds mineral compounds are included into the rotation of organic matter as a result of algae assimilation. The long time of contact with the bottom sediments, processes of nitrification and denitrification, and precipitation of phosphates during the formation of calcium carbonate cause a high degree of elimination of soluble mineral compounds of phosphorus and nitrogen. A part is also deposited as bottom sediments in the form of organic compounds. Elimination of sodium and potassium in the ponds is lower because of the small demand of phytoplankton for these compounds.

The process of self-purification of wastes in accumulation ponds can be divided into four stages:

**Heterotrophy.** In connection with the campaign character of the beet sugar industry, the accumulation of wastes and their subsequent self-purification takes place in the winter months and in spring, thus, in unfavourable thermal conditions. Hence, the daily reduction of organic matter expressed in terms of  $BOD_5$  was in the investigated ponds from 68 kg  $O_2$ /ha to 54 kg  $O_2$ /ha in the ponds Łąkowy and Zimowy Wielki respectively. In southern countries anaerobic ponds are able in the summer months to eliminate 600 kg  $BOD_5$ /ha/d and from municipal sewage even more (Parker 1962, Van Eck, Simpson 1966), these processes being inhibited in winter (water temperature not lower than  $10^\circ C$ ). According to Oswald et al. (1963) a decrease in temperature below  $18^\circ C$  causes a fall in the rate of formation of methane and in sewage ponds deposits of undecomposed organic matter. In Central European countries the daily reduction of  $BOD_5$  (Uhlmann, Vegelin 1966, Godzik, Kotulski, Szczygieł 1966) is similar to that obtained in purification of beet sugar factory wastes.

The length of the period of mineralization of sewage in the pond depends on the amount of organic matter introduced into the pond and should be regulated by diluting the sewage with water.

In the self-purification processes of sugar factory wastes in anaerobic conditions the elimination of nitrogen and phosphorus is small. During the period of self-purification of the wastes the content of phosphorus and organic nitrogen increases together with a decrease in the mineral forms of these elements. A reverse process is observed in the case of municipal sewage where, due to the decomposition of organic matter, mineral forms of nitrogen and phosphorus are accumulated (Parker 1962).

A high ratio of carbon to nitrogen and a low content of phosphorus in sugar factory wastes seem to be the main cause of this type of mineralization. Even in the final stage of wastes mineralization in anaerobic conditions with a low carbon-nitrogen ratio no increase in mineral forms of these elements was observed; this may be explained by biological sorption, mainly by phytoplankton developing in masses in this period.

**Hyperautotrophy.** The final stage of mineralization of wastes is characterized by a mass development of phytoplankton (Kyselowa 1973), which changes the anaerobic conditions into aerobic ones in the process of autotrophy. Never was such a high primary production observed in minerally fertilized ponds as in waste ponds. In the investigations carried out by Wróbel (1962, 1965 a) for many years, maximum production did not exceed 15 mg O<sub>2</sub>/l/d. In the pond Zimowy Wielki the production in the surface layers exceeded 30 mg O<sub>2</sub>/l/d. The high production of phytoplankton in sewage ponds has already been mentioned by many authors (Copeland, Doris 1962, Uhlmann 1965, 1966, Nasr, Mowad 1969) and was usually associated with a high content of carbon dioxide in the water (Kuentzel 1969, King 1970).

In ponds with flowing water net production constitutes a small part of the total production as the effect of a constant inflow of allochthonous organic substance. This ratio of production to destruction occurs only in the first phase of the stage in question, where the influence of the not decomposed organic matter of sewage origin is still noticeable.

In the following period the ratio of net to total production is similar to that in minerally fertilized ponds. The ratio of net production to total production is connected with the developmental stage of phytoplankton and physical conditions in the pond. Some days after the mass development of phytoplankton a supersaturation of the water with oxygen was observed in the investigated ponds; this amounted to 300 per cent and according to the published data from 1970 even over 800 per cent. A pronounced stratification of oxygen, connected with great turbidity caused by the mass development of phytoplankton and by organic and mineral suspensions

are characteristic of this type of ponds. According to Stahl and May (1967), in ponds near Washington in the surface layers 30 mg O<sub>2</sub>/l were encountered and at a depth of 90 cm a lack of oxygen. Among the investigated ponds only in the pond Polny III was a value lower than 0.5 mg O<sub>2</sub>/l observed close to the pond bottom together with supersaturation of the water with oxygen in the surface layers, this being connected with the great depth of this pond and incomplete daily circulation at that time.

Measurement of primary production by means of the bottle method was at that time complicated because of high production and extreme values of oxygen content. In conditions of supersaturation of the water with oxygen measurement by means of light bottles is rather difficult, whereas a low oxygen content causes some difficulty in measuring the destruction of organic matter. In such conditions a shortened period of exposure (Hepher 1962) or even dilution (Nasr, Moawad 1969) are generally accepted. A shortened period of exposure and calculation of production per day leads to fairly large errors because of a different course of photosynthesis in the diurnal rhythm. A lower intensity of photosynthesis in the afternoon hours is connected with the exhaustion of mineral components and especially CO<sub>2</sub> or with the destructive influence of light on chlorophyll (Steeman Nielsen, Jørgensen 1962). The time of maximum saturation of water with oxygen is closely connected with the course of the intensity of photosynthesis.

As results from investigations carried out in the pond Zimowy Wielki over 24 hours, maximum saturation of the surface water layers with oxygen was found about 3 p. m., whereas in deeper layers it occurred at 12 p. m. It seems that the fall in intensity of photosynthesis in deeper layers of the water was not caused by the physico-chemical limiting factors but should be rather connected with the physiological state of the algae (during 24 hours investigations a sudden decay of the phytoplankton following intensive water-bloom).

In these conditions measurements of the primary production serve as an index of the intensity of production and decomposition of organic matter. Dilution of the water may lead to still greater errors because of changes in the physico-chemical conditions of the environment.

**Transition.** The period of high photosynthesis of the phytoplankton is not long. It lasts for about two weeks and is followed by a sudden decay of the phytoplankton. The final stages of water-bloom of the phytoplankton are connected with a vigorous development of the zooplankton, in the initial phase, mainly populations of rotifers and subsequently of cladocerans (water fleas) (Kyselowa 1973). The duration of this period varied within a wide range from six months in the pond Polny III to 2—3 weeks

in the other ponds. The characteristic features of the water at that time were: small turbidity, low oxygen content, and fairly high oxidability. This indicates great participation of dissolved organic matter originating from the decomposition of phytoplankton. At the same time accumulation of mineral compounds in the water takes place in consequence of the decomposition of organic matter in the bottom sediments.

**Stabilization.** A new development of phytoplankton is connected with the decay of zooplankton. In the pond Zimowy Wielki, dying of *Daphnia magna* occurred during 3 days following maximum development. Development of phytoplankton is no longer so intensive as during transition from anaerobic to aerobic conditions. This is not only connected with a decrease in the content of nutrient components in the water but also with the influence of fish on the environment. Feeding by the fish causes greater turbidity of the water in consequence of an increase in mineral suspensions which in turn limits the access of light into the deeper layers of the water. In these conditions photosynthesis occurs only in the surface layers. The presence of fish causes a certain biological balance in the process of formation and decomposition of organic matter. Feeding by the fish prevents mass development of zooplankton, which may cause filtering off of the phytoplankton and facilitate a constant supply of mineral components from the bottom. The dynamics of the changes of organic matter in the water and mineral and organic forms of nitrogen and phosphorus is similar to that in minerally fertilized ponds.

The influence of wastes on the bottom sediments was above all seen in the increase in the sorption complex and change in reaction. Besides a high content of organic matter in the wastes the increase in the sorption complex could also have been influenced by loamy substances originating from beet washing.

The high hardness of wastes influenced the reaction of the soil in the pond, the decrease in hydrolytic acidity, and enrichment of the sorption complex in calcium and magnesium compounds. A part of these elements was deposited in the soil in the form of carbonates. The high content of calcium and magnesium compounds in the wastes makes liming of the ponds in the examined complex unnecessary. These ponds require constant liming when filled with water from the River Bajerka (Pasternak 1968).

Liming of ponds filled with beet sugar factory wastes did not accelerate the mineral processes and caused only a large accumulation of calcium carbonates in the sediments.

The low content of organic carbon and nitrogen in the sediments of the accumulation ponds indicates a favourable mineralization process and not the accumulation of organic bottom sediments. This permits exploitation of ponds as accumulation reservoirs every year.

## STRESZCZENIE

Badano procesy samooczyszczania się ścieków cukrowniczych w stawach rybnych. Badania przeprowadzono w latach 1967—1968 na czterech stawach produkcyjnych należących do Gospodarstw Doświadczalnych Zakładu Biologii Wód PAN w Gołyszach w powiecie cieszyńskim. Badane stawy napełniono ściekami mieszanymi w czasie trwania kampanii cukrowniczej (jesień—zima), a po samooczyszczeniu się ścieków stawy zarybiano karpami w miesiącach wiosennych.

Czas samooczyszczania się ścieków w stawach zależał od zawartości substancji organicznych w ściekach i wahał się od 3 miesięcy przy stosowanym rozcieńczeniu ścieków wodą czystą do 6 miesięcy w stawie, gdzie ścieków nie rozcieńczano. Średnia dzienna redukcja BZT<sub>5</sub> w badanych stawach wynosiła 54—68 kg O<sub>2</sub>/ha. Nie stwierdzono wpływu wapnowania ścieków na tempo mineralizacji substancji organicznej.

W procesie samooczyszczania się ścieków wydzielono cztery etapy.

Etap heterotrofii. Rozkład substancji organicznych występował w warunkach beztlenowych. Przy wysokiej zawartości substancji organicznej w ściekach (ryc. 2, 11) stwierdzono ich niską utlenialność (ryc. 4, 12). Azot i fosfor występował głównie w połączeniach organicznych przy stale zmniejszającej się zawartości mineralnych form tych pierwiastków w miarę samooczyszczania się ścieków (ryc. 7, 13). W warunkach beztlenowych eliminacja azotu i fosforu z wody była bardzo niska.

Etap hiperautotropii. Po spadku zawartości substancji organicznej BZT<sub>5</sub> poniżej 50 mg O<sub>2</sub>/l i ChZT poniżej 200 mgO<sub>2</sub>/l procesy autotroficzne zaczynają przeważać nad heterotroficznymi. Masowy rozwój glonów planktonowych i fotosyntetyczne natlenianie wody powoduje przejście z warunków beztlenowych na tlenowe. Zawartość tlenu w wodzie często przekracza 200% nasycenia (ryc. 5), a produkcja pierwotna fitoplanktonu przekracza 30 mg O<sub>2</sub>/l/d (rys. 21). W stawach użyźnianych ściekami cukrowniczymi stwierdzono wyższą produkcję pierwotną fitoplanktonu w porównaniu do stawów nawożonych mineralnie. Związane jest to z dużą zawartością dwutlenku węgla dostarczanego do wody w wyniku rozkładu substancji organicznej oraz z wysoką węglanową twardością ścieków. W ciągu krótkiego okresu czasu następuje silna eliminacja mineralnych i organicznych połączeń fosforu i azotu (ryc. 7, 13) wraz z biologicznym odwapnieniem wody (ryc. 9, 15).

Etap przejściowy. Wyczerpanie składników mineralnych w okresie masowego rozwoju fitoplanktonu powoduje spadek fotosyntezy, a następnie gwałtowne obumarcie fitoplanktonu przy masowym rozwoju wioślarek. Zawartość rozpuszczonego w wodzie tlenu spada poniżej 2 mg O<sub>2</sub>/l a w wodzie następuje nagromadzenie się produktów rozkładu fitoplanktonu, głównie azotu amonowego. W stawie Polny III, który w 1967 roku nie był obsadzony karpami, długość tego etapu trwała 6 miesięcy (ryc. 5, 7) a w pozostałych stawach przez okres kilku tygodni (tabela VI i VII).

Etap stabilizacji. Etap ten odpowiada stawom rybnym nawożonym mineralnie. Występuje pewna równowaga biologiczna pomiędzy syntezą a rozkładem substancji organicznej, przy małych wahaniami zawartości tlenu. Azot i fosfor występują głównie w połączeniach organicznych, a odczyn wody waha się w niewielkim zakresie. Przy opuszczaniu stawów w czasie odłowu ryb zawartość substancji organicznej oraz azotu i fosforu w wodzie zbliżona jest do zawartości tych składników w stawach nie użyźnianych ściekami (tabela VIII). Wskazuje to na pełną mineralizację substancji organicznych zawartych w ściekach oraz wysoką eliminację azotu i fosforu.

W stawie Łąkowy zalany w 1967 roku ściekami, a w 1968 roku wodą czystą, produkcja pierwotna fitoplanktonu oraz zawartość fosforu i azotu w 1968 roku występowały na poziomie stawów nie nawożonych (tabela V). W glebach stawów użyźnianych ściekami nie stwierdzono akumulacji substancji organicznej. Wysoka zawartość

wapnia i magnezu w ściekach spowodowała wzrost odczynu gleby stawowej oraz zwiększenie sumy zasad wymiennych w powierzchniowej warstwie dna (tabela IX—XI).

Produkcja ryb w stawach ściekowych uzależniona była od gęstości obsad (tabela XII) i przewyższała kilkakrotnie produkcję w stawach kontrolnych.

## REFERENCES

- Antipčuk A. F., Z. A. Makina, E. M. Francuzova, 1969. Kratkaja gidrobiologičeskaja charakteristika očistnych vodoemov Krasnjanskogo Sacharnogo Zavoda. Rybnoe Chozj. 45, 9, 38—42.
- Breest F., 1925. Über die Beziehung zwischen Teichwasser, Teichschlamm und Teichuntergrund. Arch. Hydrobiol. Plankt., 15, 422—454.
- Chmielowski J., 1966. Kinytika i mechanizm fermentacji metanowej — Kinetics and mechanism of methane fermentation. Politechnika Śląska. Zeszyty Naukowe, 165, 1—120.
- Copeland B. J., C. Dorris, 1966. Photosynthetic productivity in oil refinery effluent holding ponds. J. Water Poll. Control Fed., 34, 1104—1111.
- Czensny R., 1961. Wasser-, Abwasser- und Fischereichemie. Berlin, Verl. Technik., 1—429.
- Demoll R., 1926. Die Reinigung von Abwässern in Fischteichen. Handb. Binnenfisch. Mitteleuropas. 6, 22—262.
- Eck H. van, D. E. Simpson, 1966. The Anaerobic Pond System. J. and Proc. Inst. Sew. Purif., 3, 3—12.
- Einsele W., 1938. Über chemische und kolloid chemische Vorgänge in Eisen-Phosphat-System unter limnochemischen und limnogeologischen Gesichtspunkt. Arch. Hydrobiol., 33, 361—387.
- Fereńska M., S. Lewkowicz, 1966. Zooplankton stawów na tle niektórych czynników chemicznych — Zooplankton in ponds in relation to certain chemical factors. Acta Hydrobiol., 8, Suppl., 1, 127—159.
- Feuillade J., M. Laurent, 1969. Essai d'une méthode d'investigation pour l'étude du cycle de l'azote dans les étanges. Rech. Hydrobiol. Contin., (I), 5—21.
- Fewson C. A., J. D. Nicholas, 1961. Utilization of nitrate by microorganisms. Nature, 190, 4770, 2—7.
- Fitzgerald G. P., Rohlich G. A., 1964. Biological removal of nutrients from treated sewage: laboratory experiments. Verh. Internat. Verein. Limnol., 15, 597—608.
- Godzik S., B. Kotulski, P. Szczygieł, 1963. Badania nad oczyszczaniem ścieków Zakładów Chemicznych „Oświęcim” metodą stawów ściekowych. Gaz. Woda i Techn. Sanit., 37, 19—24.
- Hepher B., 1962. Primary production in fishponds and its application to fertilization experiments. Limnol. Oceanogr., 7, 131—136.
- Iłčenko N. I., A. M. Matvenko, 1969. K izučenii algoflory stočnych vod sacharnogo zavoda. Hidrobiol., Ž. 5, 5, 82—85.
- Just J., W. Hermanowicz, 1964. Fizyczne i chemiczne badanie wody do picia i potrzeb gospodarczych. Warszawa, PZWL.
- King D. L., 1970. The role of carbon in eutrofication. J. Water Poll. Control Fed., 42, 2035—2051.

- Kisskalt K., H. Ilzhofer, 1937. Reinigung von Abwasser in Fischteichen. *Archiv. Hyg.*, 118, 1—66.
- Kołaczkowski S., Z. Meybaum, 1962. Badania porównawcze nad oznaczeniem utleniałości substancji ściekowych. *Gaz, Woda i Techn. Sanit.*, 36, 310—313.
- Kryutchkova N. M., 1968. The role of zooplankton on the self-purification in water bodies. *Hydrobiol.* 31, 585—596.
- Kuentzel L. E., 1969. Bacteria, carbon dioxide and algal blooms. *J. Water Poll. Control Fed.*, 41, 137—147.
- Kyselowa K., 1973. Plankton stawów zasilanych ściekami cukrowniczymi — The plankton of ponds enriched with wastes from beet sugar factories. *Acta Hydrobiol.*, 15, 51—88.
- Lewkowicz S., S. Wróbel, 1971. Some chemical factors and primary production of phytoplankton in fingerling ponds. *Pol. Arch. Hydrobiol.*, 18 (31), 189—201.
- Lityński T., H. Jurkowska, E. Górlach, 1962. Analiza chemiczno-rolnicza. Gleba i nawozy. Warszawa, PWN.
- Makina Z. A., 1967. Opyt wyrašćivanija tovarnych segoletkov karpa v očiščennych stočnych vodach Krasnjanskogo Sacharnogo Zavoda. *Rybnoe Chožj.*, 43, 3, 38—42.
- Mejen V. A., 1932. Očištka stočnoj zidkosti v prudach i vyrašćivanie v nich ryby. *Izd. Vsesojuz. Naučno-Inženerenogo-techničeskogo ob-va i San. Techn.*, 119, 1—60.
- Michalski K., 1951. Zmiany biocenozy rzeki Zgłowiączki w wyniku zanieczyszczenia ściekami cukrowni. *Kosmos, A*, 66, 162—208.
- Mortimer C. H., 1941/1942. The exchange of dissolved substances between mud and water in lakes. W-in: Mortimer C. H., C. F. Hickling., 1954. *Fertilizers in Fishponds. Col. Office, Fishery Publ.* 5, 1—155.
- Nasr A. H., S. K. Moawad, 1969. Oxygen balance in Microstabilization ponds. *Hydrobiol.*, 34, 135—144.
- Ohle W., 1938. Die Bedeutung der Austauschvorgänge zwischen Schlamm und Wasser für den Stoffkreislauf der Gewässer. W — in: Mortimer C. H., C. F. Hickling, 1954. *Fertilizers in Fishponds. Col. Office, Fishery Publ.*, London, 5, 1—155.
- Oswald W. J., C. G. Gloueke, R. C. Cooper, H. K. Gee, J. C. Bronson, 1963. Water reclamation, algal production and methane fermentation in waste ponds. *Int. J. Air Wat. Poll.*, 627—648.
- Parker C. D., 1962. Microbial aspects of lagoon treatment. *J. Water Poll. Control Fed.*, 34, 149—161.
- Pasternak K., 1958. Wpływ różnych materiałów glebowych dna stawu na skład chemiczny wody. — Einfluss der Bodenzusammensetzung des Teichgrundes auf die chemische Beschaffenheit des Wassers. *Biul. Zakł. Biol. Stawów PAN*, 7, 27—66.
- Pasternak K., 1959. Gleby gospodarstw stawowych dorzecza Górnej Wisły — Soils of the fish ponds in the upper basin of river Vistula. *Acta Hydrobiol.*, 1, 221—283.
- Pasternak K., 1965. Gleby stawowe utworzone z utworów pyłowych — Pond soils formed out of silt loam formations. *Acta Hydrobiol.*, 7, 1—26.
- Pasternak K., 1966. Skład chemiczny wody stawów zanieczyszczonych ściekami kopalń węgla kamiennego — Chemische Zusammensetzung eines Teichwassers, welches durch Abwässer von Kohlengruben verunreinigt ist. *Acta Hydrobiol.*, 8, 79—85.
- Pasternak K., 1967. Skład chemiczny wody stawów na terenach piaszczystych — The chemical composition of the water of ponds in sandy terrains. *Acta Hydrobiol.*, 9, 111—127.
- Pasternak K., 1968. Geneza, ewolucja i wartość użytkowa mineralnych gleb stawowych. *Postępy Nauk Roln.*, 1, (109), 44—45.



- Prosjanya V. S., Z. A. Makina, E. M. Francuzova, 1965. Ispolzovanie vodomov stočnych vod sacharnych zavodov dlja vyraščivania ryby. Rybnoe Chozj., 41, 2, 21—25.
- Pytlik R., 1957. Oczyszczanie ścieków domowych oraz organicznych ścieków przemysłowych metodą stawów akumulacyjnych i asymilacyjnych — Reinigung der Haus- sowie der organischen Industrie-Abwässer durch Akumulation- und Assimilation-Teiche. Biul. Zakł. Biol. Stawów PAN, 5, 119—132.
- Pytlik R., R. Lavicky, M. Kalina, J. Mytiska, J. Dworak, 1957. Akumulacni rybnik Malikovsky v letech 1953 až 1956. Sbor. Českol. Akad. Věd. Zivoč. Vyroba, 2, 329—348.
- Pytlik R., J. Votava, V. Beneš, 1954. Čisteni a využitkovani rizkovych odpadnich vod cukrovarych v akumulacnich rybnících. Sbor. Českol. Akad. Žemed. Věd, C, 337—344.
- Rohlich G. A., 1963. Methods for the removal of phosphorus and nitrogen from sewage plant effluents. Inter. J. Air Wat. Poll., 7, 427—432.
- Schiemenz P., 1902. Weitere Studien über die Abwässer der Zuckfabriken und über den Wert der biologischen Untersuchungsmethoden. Fischerei., 10, 3, 147—185.
- Serenkov G.P., M.V. Pachomova, 1960. Izučenie azotistych soedinenij vodoroslej. Vestnik Moskov. Univ., 6, 15—25.
- Sivko T.N., V.P. Lachnovič, 1967. Nabludenia na prudach biologičešskoj očiški stočnych vod sacharnogo zavoda. Hidrobiol. Ž., 3, 1, 54—60.
- Sládeček V., Z. Cyrus, A. Borovičková, 1958. Hydrobiological investigation of a treatment of a beet sugar factory's wastes in an experimental lagoon. Sborn. Vysoke Školy Chemicko-Technol. Paliva a Vody, 2, 2, 7—120.
- Sowa R., 1959. Fauna unoszona (syrton) rzeki Bajerki — Syrton of stream Bajerka. Acta Hydrobiol., 1, 197—213.
- Stahl J.B., D.S. May, 1967. Microstratification in waste treatment ponds. J. Water Poll. Control Fed., 39, 72—88.
- Stangenberg M., 1949. Nitrogen and carbon in the bottom deposits of lakes and the soils under carp ponds. Verh. Internat. Verein. Limnol., 10, 422—437.
- Stangenberg M., 1958. Ogólny pogląd na skład chemiczny wód rzecznych Polski — A general outlook on the chemical composition of river waters in Poland. Pol. Arch. Hydrob. 4 (17), 21—37.
- Stangenberg-Oporowska K., 1967 a. Potassium in Polish Carp ponds. Pol. Arch. Hydrobiol., 14 (27), 21—37.
- Stangenberg-Oporowska K., 1967 b. Sodium contents in carp pond waters in Poland. Pol. Arch. Hydrobiol., 14 (27), 11—17.
- Stangenberg-Oporowska K., A. Solski, 1964. Stan zanieczyszczenia górnego biegu rzeki Odry — Pol. Arch. Hydrobiol., 12 (25), 81—123.
- Starmach K., 1958. Wydajność stawów nawożonych superfosfatem w gospodarstwie doświadczalnym PAN w Ochabach w latach 1952—1956 — Ergebnisse der Teichdüngung in der Versuchsteichwirtschaft Ochaby der Polnischen Akademie der Wissenschaften für die Jahre 1952—1956. Biul. Zakł. Biol. Stawów PAN, 5, 81—95.
- Starmach K., 1960. Biologia sanitarna. Kraków, PWN.
- Steeman Nielsen E., E.G. Jorgensen, 1962. The Physiological Background for using Chlorophyll Measurements in Hydrobiology and Theory explaining Daily Variations in Chlorophyll Concentration. Arch. Hydrobiol., 58, 349—357.
- Uhlmann D., 1965. Beitrag zur Limnologie extrem nährstoffreichen Flachgewasser. Wiss. Z. Univ. Leipzig, Math.-Nat. Reihe, 14, 359—411.
- Uhlmann D., 1966. Produktion und Atmung im hypertrophen Teich. Verh. Internat. Verein. Limnol., 16, 934—941.

- Uhlmann D., R. Wegelin, 1966. Oxydationsteiche, Theorie, Betriebserfahrungen, Hinweise für Bau und Betrieb. Mitt. Wiss. Techn. Zentrum Leipzig VVB Wasser-versorg. u. Abwasserbehandl. 1—36.
- Vinberg G.G., 1960. Perviĉnaja produkcja vodoemov. Minsk, Min. Vysš. Sred. Specjal. i Prof. Obrazov. BSSR.
- Whurmann K., 1964. Nitrogen removal in sewage treatment process. Verh. Internat. Verein. Limnol., 15, 580—596.
- Wolny P., 1962 a. Hodowla ryb w stawach nawadnianych oczyszczonymi ściekami miejskimi. Gosp. Ryb., 14, 4, 6—9.
- Wolny P., 1962 b. Przydatność oczyszczonych ścieków miejskich do hodowli ryb. Rocz. Nauk Roln., B, 81, 231—250.
- Wróbel S., 1959. Wstęp do badań lizymetrycznych dna stawowego — Einführung in die lysimetrischen Teichboden — Untersuchungen. Acta Hydrobiol., 1, 87—107.
- Wróbel S., 1962. Wpływ nawożenia azotowo-fosforowego na skład chemiczny wody, produkcję pierwotną fitoplanktonu i przyrosty ryb w stawach — Einfluss der Stickstoff-Phosphordüngung auf die chemische Zusammensetzung des Wassers, auf die Primärproduktion des Phytoplanktons und auf den Fischzuwachs in Teichen. Acta Hydrobiol., 4, 151—204.
- Wróbel S., 1963. Wpływ zmian warunków atmosferycznych na dobowe wahania niektórych czynników w wodzie stawów — Wechselwirkung atmosphärischer Zustände auf die Tagesschwankungen einiger Faktoren im Teichwasser. Acta Hydrobiol., 5, 73—77.
- Wróbel S., 1965 a. Przyczyny i następstwa eutrofizacji stawów — Causes and consequences of pond eutrophication. Acta Hydrobiol., 7, 27—52.
- Wróbel S., 1965 b. Skład chemiczny wody stawów Południowej Polski — Die chemische Zusammensetzung des Wassers in den Teichen Südpolens. Acta Hydrobiol., 7, 303—316.
- Zdybniewska M., 1960. Oznaczanie chemicznego zapotrzebowania tlenu w ściekach. Gaz, Woda i Techn. Sanit., 34, 254—257.
- Zięba J., 1973. Makrobentos stawów z ściekami cukrowniczymi — Macrobenthos of ponds with sugar factory wastes. Acta Hydrobiol., 15, 113—129.

Adres autora — Author's address

mgr Stanisław Lewkowicz

Zakład Doświadczalny Polskiej Akademii Nauk, Gołysz-Zaborze, poczta Chybie,  
pow. Cieszyn

## ERRATA

Strona — Page	Wiersz — Line		Zamiast — Instead of	Winno być — Ought to be
	od góry from above	od dołu from below		
7	3		turbicity	turbidity
7		8	released	released
23	3		added	added
45	20		hiperautotropii	hiperautotrofii
47		23	Gloueke	Golueke
54		12	If	It
74	22		<i>Ankistrodemus</i>	<i>Ankistrodesmus</i>
79	11		<i>Quadringula</i>	<i>Quadrigula</i>
81	17		<i>Cyclopidea</i>	<i>Cyclopidae</i>
84	11		niektórych	niektóre
84		6	<i>Polyartha</i>	<i>Polyarthra</i>
84		4	<i>magma</i>	<i>magna</i>
87	13		y	I.
90		5	Haluška	Hanuška
108		17	of investigation in 1968 the third association of <i>Ciliata</i> occurred, the	of May. Large numbers of <i>Ci- liata</i> were also found at the be- ginning of association
108		9	asseociation	association
111	1		Macrbenthos	Macrobenthos
115	11		<i>Glycoria</i>	<i>Glyceria</i>
119		6	afuna	fauna
121	11		<i>conjungens</i>	<i>conjugens</i>
125	4		<i>Psecrocladius</i>	<i>Psectrocladius</i>
127	19		indicatesthe	indicates the
128	9		<i>Chyptochirono- mus</i>	<i>Cryptochirono- mus</i>
wkładka — insert (Lewko- wicz)	7		автофильтрации	самоочищения
wkładka — insert (Kyselowa)	8		автофильтрации	самоочищения
insert (Huk)	12, 13		фильтрации	очищения
insert (Grabacka)	6,9,10		автофильтрации	самоочищения