

PL ISSN 0065-1583

POLISH ACADEMY OF SCIENCES  
NENCKI INSTITUTE OF EXPERIMENTAL BIOLOGY

# ACTA PROTOZOOL- LOGICA

VOLUME 25

Number 2

PANSTWOWE WYDAWNICTWO NAUKOWE

W A R S Z A W A 1 9 8 6

<http://rcin.org.pl>

**ACTA PROTOZOLOGICA**  
**International Journal of Protozoology**

*Editors*

Stanisław DRYL and Stanisław L. KAZUBSKI

*Editorial Board*

Chairman: Leszek KUŹNICKI

Vice-chairman: Andrzej GRĘBECKI

*Members*

Stanisław DRYL  
Vassil GOLEMANSKY  
Witold KASPRZAK  
Stanisław L. KAZUBSKI

Jiří LOM  
Georg Ivanovič POLJANSKY  
Igor Borysovič RAIKOV  
Ksenia Mironovna SUKHANOVA

*Managing Editor and Editorial Board Secretary*

Julitta PŁOSZAJ

Manuscripts may be submitted to the Editorial Office: Acta Protozoologica, M. Nencki Institute of Experimental Biology, 02-093 Warszawa, 3 Pasteur Street, Poland, or to each member of the Editorial Board.

Subscription orders for all the magazines published in Poland available through the local press distributors or directly through the

Foreign Trade Enterprise

ARS POLONA

00-068 Warszawa, Krakowskie Przedmieście 7, Poland

Our bankers:  
BANK HANDLOWY WARSZAWA S.A.

ACTA PROTOZOLOGICA appears quarterly. The indexes of the previous volume appear in No. 1 of the next volume.

Indexed in Current Contents and in Protozoological Abstracts.

Morphology of the Anterior Fibrillar System  
in Two Species of the Genus *Entodinium* (*Ciliophora*, *Entodiniomorpha*), and its Formation during the Bipartition Process

Susana SERRANO, M. Teresa FERNANDEZ-GALIANO  
and Dimas FERNANDEZ-GALIANO

Departamento de Microbiología, Facultad de Biología,  
Universidad Complutense, 28040 Madrid, España

Received on 28 May, revised on 31 October 1985

*Synopsis.* The subject of this study is the anterior fibrillar system and its formation during the bipartition process in two species of *Ophryoscolecidae* commensals found in the rumen of domestic animals: *Entodinium longinucleatum* and *Entodinium caudatum*. The formation of the anterior fibrillar system during the division of these ciliates coincides with the development of the adoral polybrachykinety primordia, but both processes are not simultaneous. The fibrillar system of the new specimen is formed "de novo" and it is completely independent of the fibrillar system of the parental cell that is not modified in this process.

Sharp (1914) was the first to describe the existence of a fibrillar system in *Diplodinium ecaudatum* (*Epidinium ecaudatum*) that is located in the anterior part of the body. It is composed of a main bundle with several fibres detached from it in both directions. He attributed a nervous function to this fibrillar system and called it neuromotor apparatus. Some authors do not consider it to have a neuromotor function. Bretschneider (1934) for instance considered it responsible for the maintenance of the body shape and Rees (1922) thought that these fibres had a mechanical function (this author described a neuromotor apparatus in *Paramecium* but its existence has never been proved).

Other authors like Fernández-Galiano (1949, 1955 b) and Noirot-Timothée (1952, 1960) agree with the Sharp's interpretation, but they do not exclude the possibility of other functions of this apparatus.



Coleman and Hall (1971) considered that the structures described by Noirot-Timotheé (1960) could be composed of numerous small fibrils in the inner lips and at the base of the peristome. However, Furness and Butler (1983) observed in *Epidinium caudatum* a "subciliary reticulum" directly under the sub-kinetal rods and just under the infraciliary zone.

Our study has been directed towards a comparative study of this anterior fibrillar system in two species belonging to the genus *Entodinium*: *Entodinium caudatum* and *Entodinium longinucleatum*, which appear frequently in our samples. This study has been carried out in both the vegetative and the fission cells.

## Material and Methods

The samples were collected from the rumen of domestic cows that had been recently slaughtered in Teruel and Alcorcón (Spain).

The fluid obtained was fixed in formaldehyde 5% in the slaughter-house and was taken to the laboratory to be filtered in order to remove plant particles.

The piridinated silver carbonate method (Fernández-Galiano 1976) was used for impregnation.

## Results

### General Morphology

The species of the genus *Entodinium* have a body covered with a semirigid cuticle; beneath this structure lies the cytoplasm which can be divided into two parts: ectoplasm and endoplasm. The endoplasm is a "bag" that communicates with the environment via the buccal aperture at one end and the other via the anal orifice; the ectoplasm is in the periphery and it includes the nuclei and the adoral ciliary zone with its associated fibrillar structures.

In the front part of the body is the buccal aperture and the single ciliary zone of the organism surrounding it. This ciliary zone is protected by two ectoplasm folds (internal and external lips).

*Entodinium caudatum* has a more or less quadrangular body shape, but it is altered in its posterior end because of the existence of pellicle projections that make up the three spines in this species: one longer one in the dorsal position and two shorter ones, in the ventral zone of the body. The body is 35-50  $\mu\text{m}$  in length and 25-38  $\mu\text{m}$  in width.



*Entodinium longinucleatum* has a barrel-shaped body with a rounded posterior end. The body length averages 54  $\mu\text{m}$  by 37  $\mu\text{m}$  in width (the measurements are on fixed and stained specimens).

### Morphology of the Anterior Fibrillar System

#### (a) *Entodinium longinucleatum*

A fibrillar system can be observed at the anterior part of the ciliate body surrounding the adoral zone. This fibrillar system is made up of the circumcytopharyngeal ring, the transversal fibre, the peristomial fibres, posterior fibres and ventral branches (Pl. I 1, 2, 7 a, b).

The circumcytopharyngeal ring (r) is in the anterior part, near the adoral polybrachykinety and surrounds the oesophagus. Its dorsal edge is more anterior than its ventral edge. It consists of one fibrillar bundle that is interrupted by some anastomosis between its ends on the left side (Pl. I 1, 2, 7 a).

The peristomial fibres (p) start at the anterior zone of the circumcytopharyngeal ring and extend to the base of the ectoplasmic lips. These fibres divide into two parts at their lips, and reunite in the transversal fibre (t) near the circumcytopharyngeal ring (Pl. I 2, 7 b). The transversal fibre and the circumcytopharyngeal ring are connected by the ventral plexus (vp). This ventral plexus surrounds the ring except where a break occurs on the left side (Pl. I 1, 7 a).

The ventral branches that are isolated from the whole fibrillar system are on the ventral side and terminate in the cytoplasm (Pl. I 7 b). Some posterior fibres can also be observed in the same tract leading to the intrainfundibular portion of the adoral polybrachykinety (Pl. I 7 a).

The retrociliary fibrils are to be found at the base of the adoral polybrachykinety. They are short and slightly oblique in relation to the antero-posterior ciliate axis.

#### (b) *Entodinium caudatum*

The silver impregnation reveals a fibrillar system which is located, like in *Entodinium longinucleatum* in the anterior part of the body. Also, there are some argentophilic fibres in the spine of this ciliate responsible for the maintenance of the body shape.

When the ciliary zone contracts the main node of the anterior fibrillar system at the left-dorsal side can be observed. It is called *dorsal motorium* and is formed by a thick bundle of fibres (Pl. I 3, 7 c).

Two branches depart from the dorsal motorium (dm) and give rise to the circumcytopharyngeal ring (r) (Pl. I 5, 7 c). The transversal fibre (t) is surrounding almost completely to the circumcytopharyngeal ring (Pl. I 7 c). From these three structures depart a high number of fibres (peristomial fibres) (p) to the anterior part, that forms a basket surrounding the adoral ciliary zone (Pl. I 3, 4, 7 e, f). Among the peristomial fibres detaches a bundle (bundle of the transversal fibre) (b) (Pl. I 4, 7 c).

Some short fibres depart from the posterior part of the motorium to the zone close to the micronucleus, and some thick parallel fibres depart from its anterior part (Pl. I 7 c).

A thick bundle of fibres extends to the posterior part of the body (posterior fibres) (ps). They are disposed parallelly to the intrainfundibulary portion of the adoral polybrachykinety and on its ventral side, in the same direction, are some granulations (Pl. 6, 7 d).

When the ciliary zone is extended the circumcytopharyngeal ring surrounded by the transversal fibre (t) can be detected. The peristomial fibres are not easily observed but the dorsal and ventral plexi are recognised without difficulty (Pl. I 5).

#### Anterior Fibrillar System Formation in the Bipartition Process

In both species the formation of the fibrillar system in the opisthe is simultaneous to the ciliate bipartition, although it occurs slightly after the appearance of the adoral polybrachykinety primordia (Pl. II 8). The fibrillar system is formed "de novo". It is quite independent of the fibrillar system of the proter that is not modified during the division. The first phase in the formation of the fibrillar system is the apparition of some granulations arranged 2 : 1 : 2 : 1 at the base of the right-ventral primordium of the adoral polybrachykinety (Pl. II 9). Afterwards the granulations are reorganized under the ventral band and form a ring which increases in size progressively (Pl. II 10). Then some granulations detach from the ventral side of the ring and go to the anterior part of the body (Pl. II 8).

These granulations appear a little after in the left-dorsal primordium, and then they form a hairpin-like structure (Pl. II 11).

When the adoral polybrachykinety has been fully formed, the ring extends to the posterior part and the transversal fibre is formed upon it. The anterior fibrillar system is completely finished at the moment when both specimens are dividing from each other (Pl. II 12).



## Discussion

The circumcytopharyngeal ring and the transversal fibre constitute the most characteristic organelles of the "neuromotor apparatus" in the *Ophryoscolecidae*. They have been described in other species belonging to this family of ciliates, but they have not been described in *E. longinucleatum* and in *E. caudatum* until now.

The ventral plexus is observed in both species and is similar to that described by Noirot-Timothee (1960) in *Eudiplodinium medium*. In *E. caudatum* we have observed two plexus that may be homologous to the right and left oral plexus in *Eudiplodinium maggii* (Fernández-Galiano 1955).

The peristomial fibres, retrociliary fibre and ventral branches described by us in the genus *Entodinium* are homologous to those observed by Noirot-Timothee (1960) in *Eudiplodinium medium*.

The granulous bundle following the intrainfundibular direction is similar to the argentophilic band of grains observed in *Ophryoscolex purkinjei* (Fernández-Galiano 1949) that are considered reserve material.

The caudal fibres in *E. caudatum* have no morphological connection with the anterior fibrillar system. They are situated in the spine (a permanent structure) and are considered tonofibrills responsible for the maintenance of the body shape (Fernández-Galiano 1949) in *Ophryoscolex purkinjei*.

The species of genus *Entodinium* has a anterior fibrillar system with similar appearance to some other species of the same family. Yet, in *E. longinucleatum* this structure is more simple than in *E. caudatum* so we interpret as a evidence that the later is a more evolutionated species.

We feel there is a close relation between the adoral polybrachykinety and the argentophilic periadoral fibrillar system because of: (1) their near position and (2) their quite simultaneous aparition in the bipartition process.

We assume that the adoral fibrillar system is a whole of contractile fibrils that determine the movement of the buccal overture and of the adoral polybrachykinety.

It would be reasonable to suppose that this adoral polybrachykinety might have some influence on the formation of the anterior fibrillar system but the processes that cause the origin of this fibrillar system are still unknown.

## REFERENCES

- Bretschneider L. H. 1934: Beiträge zur Strukturlehre der Ophryoscoleciden. II. Arch. Protistenk., 82, 297-330.
- Coleman G. S. and Hall F. J. 1971: A study in the light and electron microscope of the extruded peristome and related structures of the rumen ciliate *Entodinium caudatum*. Tissue and Cell., 3, 371-380.
- Coleman G. S. and Hall F. J. 1971: Studies in the electron microscope of the adoral zone of membranelles of the rumen ciliate *Entodinium caudatum* using the technique of negative staining. Tissue and Cell., 3, 381-388.
- Dogiel V. A. 1927: Monographie der Familie *Ophryoscolecidae*. Arch. Protistenk., 59, 1-288.
- Fernández-Galiano D. 1949: Sobre el aparato neuromotor y otras estructuras protoplasmáticas de *Ophryoscolex purkinjei* Stein. Trab. Inst. José de Acosta. Biol., 2, 253-302.
- Fernández-Galiano D. 1955: El aparato neuromotor de *Eudiplodinium maggii* Fior. Bol. Real. Soc. Esp. Hist. Nat. Biol., 53, 53-70.
- Fernández-Galiano D. 1976: Silver impregnation of ciliated Protozoa: Procedure yielding good results with the pyridinated silver carbonate method. Trans. Am. Microsc. Soc., 95, 557-560.
- Furness D. N. and Butler R. D. 1983: The cytology of sheep rumen ciliates. I. Ultrastructure of *Epidinium caudatum* Crawley. J. Protozool., 30, 676-787.
- Noirot-Timothee C. 1960: Étude d'une famille de ciliés: les *Ophryoscolecidae*. Structures and ultrastructures. Ann. Sci. Nat. Zool. Biol. Anim., 12 série, 2 526-718.
- Rees C. W. 1922: The neuromotor apparatus of *Paramecium*. Univ. Calif. Publ. Zool., 20, 333-364.
- Sharp R. G. 1914: *Diplodinium ecaudatum* with an account of its neuromotor apparatus. Univ. Calif. Berkeley Publ. Zool., 13, 43-122.
- Timothee C. 1952: Le système fibrillaire d'*Epidinium ecaudatum* Crawley. (Inf. *Ophryoscolecidae*) Ann. Sci. Nat. Zool., 14, 375-392.

## EXPLANATION OF PLATES I-II

- 1, 2: Photomicrograph showing the anterior fibrillar system of *Entodinium longinucleatum*, when the ciliate is in contract stage. 1 —  $\times 1000$ , 2 —  $\times 1450$
- 3-6; Photomicrograph showing the anterior fibrillar system of *Entodinium caudatum*. In the Photos. 3-5 the peristome of the ciliate is in contract stage. In the Phot. 6 the ciliate is in extend stage. 3 —  $\times 2750$ , 4 —  $\times 2750$ , 5 —  $\times 1000$  and 6 —  $\times 1000$
- 7: Semigrammatic schemes of the anterior fibrillar system in *E. longinucleatum* (A and B) and *E. caudatum* (C-F). Arrows point fibres depart from the motorium
- 8: Formation of the anterior fibrillar system during the division of the genus *Entodinium*. A — Arrow points the first stage in the formation of the anterior fibrillar system
- 9: Detail of the apparition of the anterior fibrillar system under the right ventral primordium.  $\times 3500$
- 10-12: Photomicrographs of the three different stages of the formation of the circumpharyngeal ring and transversal fibre in the genus *Entodinium*. 10 —  $\times 3000$ , 11 —  $\times 3600$  and 12 —  $\times 500$
- Abbreviations: b — bundle of the transversal fibre, dm — dorsal motorium, dp — dorsal plexus, g — granulations, p — peristomial fibres, ps — posterior fibres, r — circumpharyngeal ring, t — transversal fibre, vb — ventral branches, vp — ventral plexus



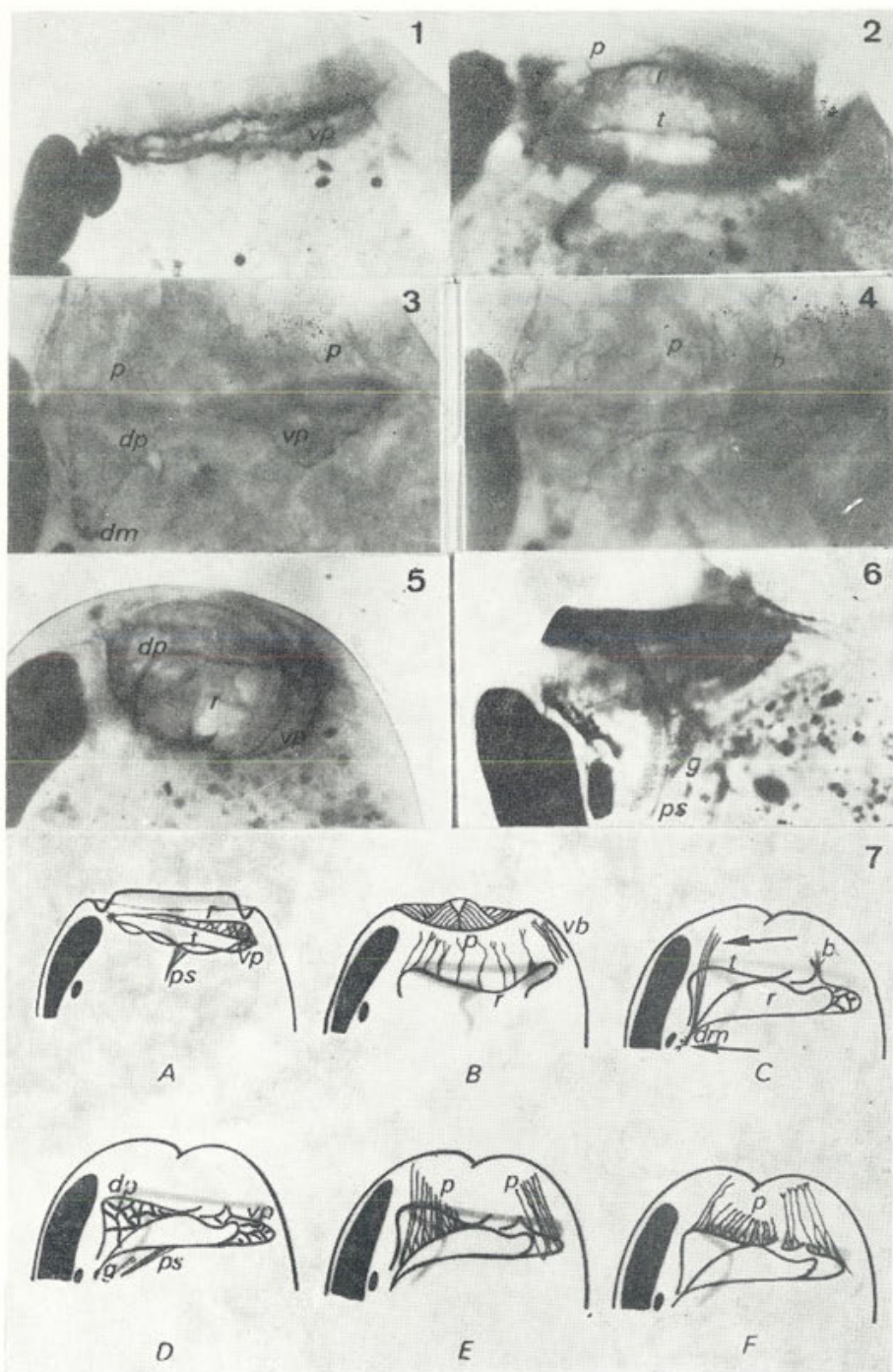

S. Serrano et al.

auctores phot.

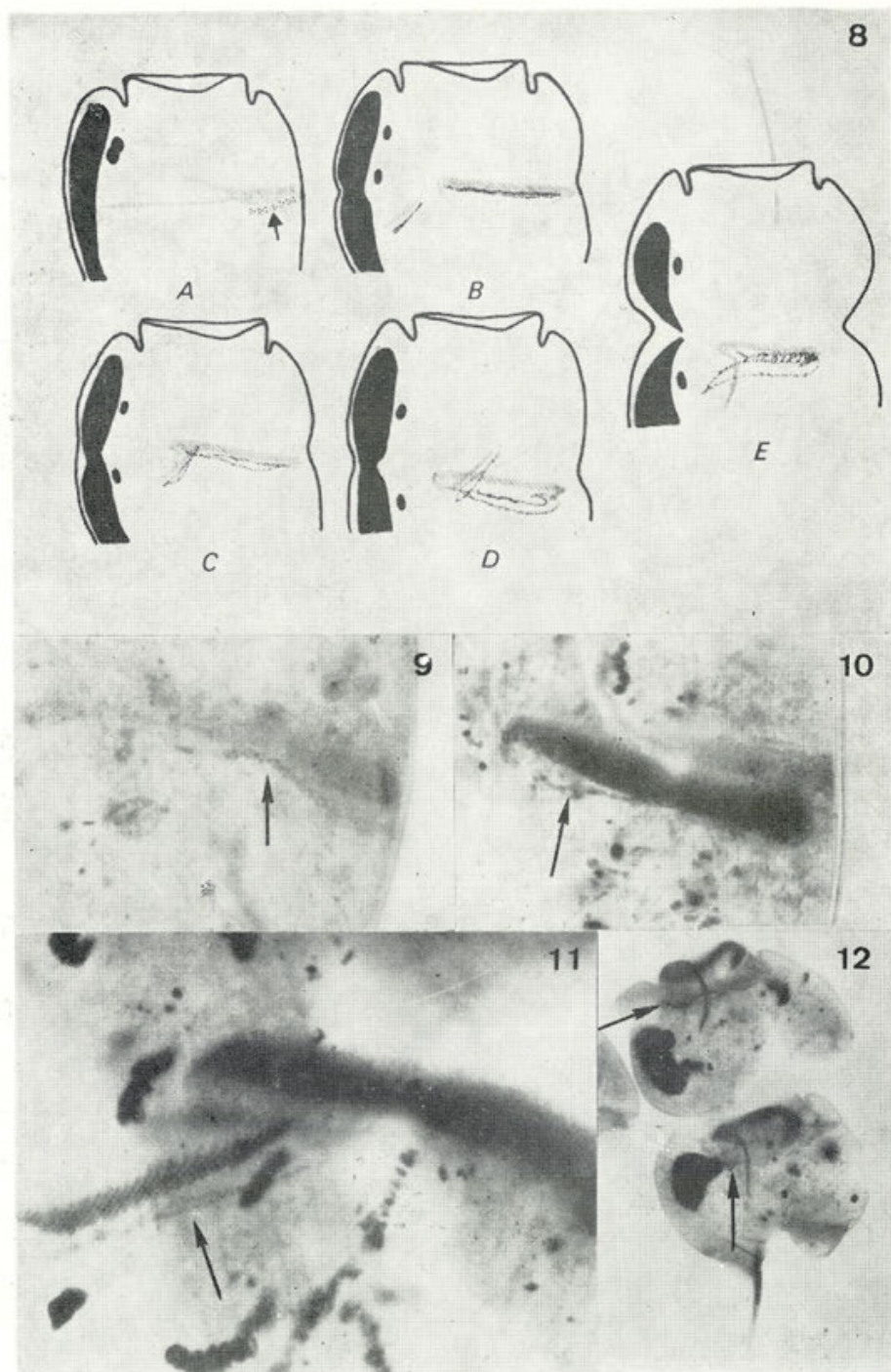

S. Serrano et al.

auctores phot.



*Pseudoentodinium elephantis* gen. nov., sp. n. from the Order  
*Entodiniomorphida*. Proposition of the New Family  
*Pseudoentodiniidae*

Maria WOLSKA

Department of Ecology and Vertebrate Zoology, University of Łódź,  
Banacha 12/16, 90-237 Łódź, Poland

Received on 16 August 1985

*Synopsis.* A ciliate species, *Pseudoentodinium elephantis* gen. nov., sp. n. which has the main features of the order *Entodiniomorphida*, but a different skeleton, is described. Particular attention was paid to its infraciliature. The adoral zone has the form typical of *Entodiniomorphida* only in its ventral part. Because of these distinctive characteristics of this new species, the creation of a new family for it is proposed.

The aim of the present paper is to present the general features and details of the infraciliature of this new ciliate and to consider its position in the order *Entodiniomorphida*.

#### Material and Methods

Samples of the excrement of Indian elephants from the Łódź Zoological Garden and the Warsaw Zoological Garden were preserved in a 10% formaldehyde. After filtering through gauze, the protozoa which had been in the filtered fluid were stained with Dobell's hematoxyline and impregnated with silver. A silver solution after Bielschovsky was used for the impregnating. The way of the impregnating was the same as in previous papers (e.g., Wolska 1980). Almost all of the protozoa observed had their adoral ciliature retracted inside the body. I could see only two individuals with ciliature which was not retracted. Thus, I described the infraciliature mainly on the basis of specimens having the ciliature drawn in. The dorsal and ventral sides were marked as it is used for *Entodiniomorphida*.

## Results

*Pseudoentodinium elephantis* gen. nov., sp. n. (Pl. I 1, 2, Fig. 2)

The outline of the body of the protozoan is approximately oval. The posterior end is rounded, the anterior end is truncated. The body is slightly flattened laterally. The cytoplasm is usually filled in with particles of food, which are rather small in size, and which may, when they are abundant, deform the protozoan. There are delicate stripes on its body surface. The oral apparatus is at the anterior pole, the cytopyge at the posterior one, in a shallow cavity. There is one contractile vacuole in the posterior part of the body. The oval macronucleus is usually situated close to the dorsal wall, in the posterior half of the body, while the longer axis of the macronucleus is parallel to the long axis of the protozoan's body. The small round micronucleus adjoins the posterior end of the macronucleus (Fig. 2), or, more rarely, its anterior end. However, it happens that the whole nuclear apparatus is differently situated. It may be significantly shifted backwards or forwards in the body, and the longer axis of the macronucleus may be sloped in regard to the long axis of the protozoan's body.

In the anterior part of the body, in the superficial layer of cytoplasm, there is the skeleton, which consists of 12 slats in the left side of the body and 12 slats in the right side, which are situated symmetrically in regard to the frontal plane of the protozoan. In each side, four middle slats, which are approximately of the same length, extend to the half of the protozoan's body length. The slats of the two pairs of tetrads which lie on both sides of the middle slats differ in length (their length decreases together with the increase in distance from the middle four long slats). In the ventral and dorsal edges of the protozoan's body the shortest, extreme slats of the left side reach the shortest, extreme slats of the right side. The distances between the slats are the same in the whole system. The slats are well seen in the silver impregnated specimens (Pl. I 2, 3, 9).

The ciliature is limited to the adoral zone in the anterior part of the body. The whole oral area may, to various extent, be drawn inside the body. When it is strongly retracted, the cilia are completely hidden in a depression that appears then and can be only partially seen through the cytoplasm. The outlet of the depression is tightened at the anterior part of the body (Pl. I 1). When the oral area is slightly pulled in the cilia may stick outside (Pl. I 9). When it is protruded, the cilia which are closer to the ventral side and which grow on the cytoplasmic cone (ciliophore) stick almost all of their length outside the outline of the



anterior part of the body; almost — because the base of the cone is slightly depressed and thus surrounded by the cytoplasmic lip. Cilia which are on the cone may be grouped into tufts. Dorsally in respect to the cone, there opens an excavation reaching to the middle of the body length — the vestibulum, which is equipped with cilia. It is strongly narrowed in the posterior end.

After impregnating with silver, several parts may be distinguished in the infraciliature. The main and the largest part of the oral infraciliature is the part lying on the cone situated on the ventral side of the protozoan, the cilia of which may protrude outside. Dense, parallel, slanting rows of kinetosomes cover the cone on its left, ventral and right sides. These rows are longest on the ventral side, and become gradually shorter on both lateral sides. The whole has the appearance of a band which is widest in its middle part and grows narrower towards its both ends (Pl. I 4, 5). The thin ends of the band penetrate the vestibulum. At the base of the cone, on the inner side of the cytoplasmic lip, on the right ventral side of the protozoan, there is a small group of kinetosomes arranged in several hardly regular rows, which run almost perpendicular to the long axis of the body (Fig. 1). Plate I 8 shows the above-mentioned group while the ciliophore is retracted. Hence, in the new ciliate, the part of the oral ciliature which lies on the ventral side has the same characteristics as in other *Entodiniomorpha*. It is particularly similar to

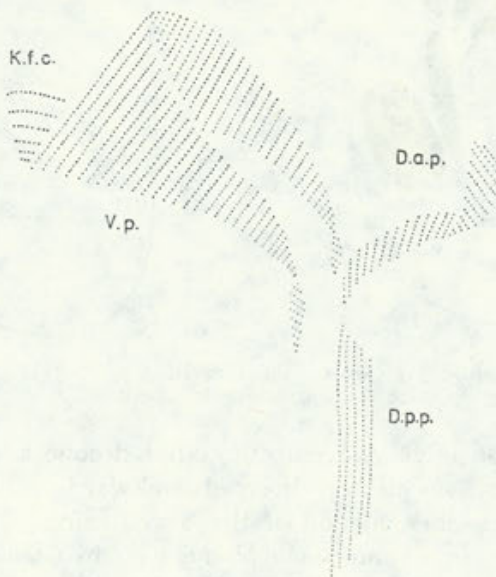

Fig. 1. *Pseudoentodinium elephantis*. Course of the rows of kinetosomes in particular parts of the adoral zone. A scheme. Ventral part (V.p.). Kinetosomes of "free cilia" (K.f.c.). Dorsal anterior part (D.s.p.). Dorsal posterior part (D.p.p.)

*Cycloposthium* and *Tripalmaria*, in which the ventral part of the oral ciliation lies on the retractable cone. A small distinct group of kinetosomes occurring in *Entodiniomorpha* (the infraciliature of which was investigated) was called "Cinetias ventrales independentes" (Fernández-Galiano 1959) or "Free cilia" (Wolska 1978). The dorsal part of the adoral ciliation of the new ciliate is built differently than in other *Entodiniomorpha*. Two separate parts of the infraciliature lie dorsally in respect to the cone on the wall of the vestibulum. The anterior part has the form of a band running obliquely along the wall of the vestibulum at the base of the cone. The band consists of short, parallel, slanting rows of kinetosomes. In the posterior part of the vestibulum there are five long rows running along the dorsal side of the vestibulum (Fig. 1, Pl I 7). The position of particular parts of the oral ciliation in relation to one another changes while they are being drawn inside the body (Fig. 2). The ventral part is then moved farthest backwards. Sometimes,

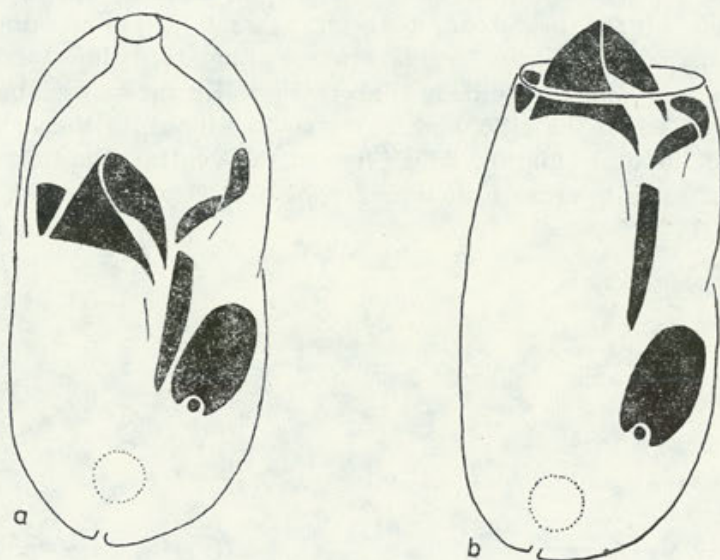

Fig. 2. *Pseudoentodinium elephantis*. Position of the adoral zone, a — retracted, b — protruded. A scheme

when the retraction is very strong, the ciliated cone is turned over, and, as a result, one can see its top directed backwards, and its base — forward (Pl. I 6). The phenomenon of the overturning of the ciliated cone is known to occur in *Entodiniomorpha*, e.g., in *Cycloposthium* (Fernández-Galiano 1959) and in *Tripalmaria* (Wolska 1978). At such a strong retraction of the adoral zone the anterior dorsal band may happen to become almost parallel to the long axis of the body, as it can



be seen in Pl. I 6. In this photograph the separateness of the anterior and posterior dorsal parts can also be seen, which is not displayed in other photographs.

The size of the protozoan ranges widely: length 27-45  $\mu\text{m}$ , breadth 14-24  $\mu\text{m}$ .

This new ciliate, which clearly belongs to *Entodiniomorphida* (strongly advanced reduction of ciliature, grouping of cilia in tufts, lateral flattening of the body, a strongly marked cytophyge and, frequent in this order, presence of the skeleton and the retractable adoral zone) is most similar to *Entodinium* from the family *Ophryoscolecidae* and to *Parentodinium* which was included into *Cycloposthiidae* by Thurston and Noiro-Timothée (1973), while by Corliss (1979) was treated as "incertae sedis". The similarity is shown by the lack of additional ciliary zones, the ability to retract the adoral zone, presence of one contractile vacuole in the posterior part of the body. It differs from *Entodinium* by the presence of a skeleton, the characteristics of the dorsal part of adoral ciliature, the shape and position of the nuclear apparatus. It differs from *Parentodinium* by the presence of a skeleton. As there is no description of the infraciliature of *Parentodinium*, it is impossible to compare these structures. However, *Pseudoentodinium* differs from *Parentodinium* and *Entodinium* strongly enough to create a new genus. *Pseudoentodinium* differs from other genera of *Entodiniomorphida*, which are grouped in several families, in the lack of additional ciliary zones, in the shape of its macronucleus in the characteristics of the dorsal part of its adoral ciliature and in the form of its skeleton, hence it cannot be ascribed to any family. Taking this into account, I suggest creating for it a new family in the order of *Entodiniomorphida*.

*Pseudoentodiniidae* fam. nov. — diagnosis

Lack of additional ciliary zones. The adoral ciliature retractable. The anterior and posterior fragments are distinguished in the infraciliature of the adoral zone in its dorsal part. The skeleton lies on both sides of the anterior part of the body and consists of slats. A type of the family *Pseudoentodinium* gen. nov.

*Pseudoentodinium* gen. nov. — diagnosis

The body is oval, slightly flattened laterally. The ciliature is limited to the adoral zone. In the infraciliature of the adoral zone there may be distinguished the ventral part on the cone with a small group of ki-

netosomes at the base of the cone, and two dorsal parts: the anterior one and the posterior one (the posterior one in the form of long rows running along the wall of the narrowed part of the vestibulum). One contractile vacuole in the posterior part of the body. An oval macronucleus, usually in the posterior part of the body, on the dorsal side, with a small round micronucleus adjoining one of its poles. The cytopyge at the posterior end of the body. The skeleton in the anterior part of the body, which consists of 12 slats in the left and right side each. A type of the genus *Pseudoentodinium elephantis* sp. n.

*Pseudoentodinium elephantis* sp. n. — diagnosis

A species with the characteristics of the genus; occurs in the digestive tract of the Indian elephant.

Discussion

The new ciliate, *Pseudoentodinium elephantis*, displays a peculiarity which is worth paying attention to. Its adoral ciliature has such a form as in *Entodiniomorphida* only in the ventral side. In the dorsal side the adoral ciliature of *P. elephantis* differs from the adoral ciliature of *Entodiniomorphida*. The peculiarity is that it has the same form as the ciliature of the vestibulum in the genus *Blepharocorys* Bundle of the family *Blepharocorythidae*. It is easy to make a comparison because many species from various families of *Entodiniomorphida* have been impregnated with silver (Fernández-Galiano 1959, Noirot-Timotheé 1960, Wolska 1978, 1980, 1985), and the infraciliature of species from the genus *Blepharocorys* have also been studied (Wolska 1966, 1971 a, b). It had been known for a very long time that in *Blepharocorys* the dorsal wall of the vestibulum was equipped with longitudinal rows of cilia, but it was only impregnating with silver which revealed the presence of another small zone of cilia lying in the anterior part of the vestibulum which is not connected with rows running lengthwise (Wolska 1966, 1971 a). These two parts of the vestibulum's ciliature have been named "a zone of short kineties" or "an anterior zone" and "a zone of long kineties" or "a posterior zone". In the new ciliate, in the dorsal side of the vestibulum, one can find in its infraciliature, as in *Blepharocorys*, an anterior band consisting of short rows of kinetosomes, and long rows in the posterior part. These two parts of the infraciliature are not connected with each another, also they are not linked with the ventral part of adoral infraciliature.



To sum up, we have in the fauna of the intestines of the Indian elephant a ciliate species which beside the features of the order *Entodiniomorphida* has in its infraciliature a feature of the genus *Blepharocorys* which is a type of the family *Blepharocorythidae*. This makes more credible the hypothesis that there exists close affinity between *Entodiniomorphida* and *Blepharocorythidae* (Wolska 1966, 1967), or even that *Entodiniomorphida* have originated from *Blepharocorythidae* (Noirot-Timothee 1969, Wolska 1971 b).

## REFERENCES

- Corliss J. O. 1979: The Ciliated Protozoa. Characterization, Classification and Guide to the Literature. Pergamon Press, Oxford, 455 pp.
- Fernández-Galiano D. 1959: La infraciliación en *Cycloposthium endentatum* Strelkov. Boln. R. Soc. Esp. Hist. Nat., 57, 139-150.
- Noirot-Timothee C. 1960: Etude d'une famille de ciliés: *Ophryscotlecidae*. Structures et ultrastructures. Anns. Sci. Nat. Zool. (sér. 12), 2, 527-718.
- Noirot-Timothee C. 1969: Les affinités des *Entodiniomorphida* (Ciliata). Progress in Protozoology, Abstr. Third Int. Congr. Protozool. "Nauka", Leningrad, July 1969, 371.
- Thurston J. P. and Noirot-Timothee C. 1973: Entodiniomorph ciliates from the stomach of *Hippopotamus amphibius*, with description of two new genera and three new species. J. Protozool., 20, 562-565.
- Wolska M. 1966: Study on the family *Blepharocorythidae* Hsiung. I. Preliminary remarks. Acta Protozool., 4, 97-103.
- Wolska M. 1967: Study on the family *Blepharocorythidae* Hsiung. II. *Charonina ventriculi* (Jameson). Acta Protozool., 4, 279-283.
- Wolska M. 1971a: Studies on the family *Blepharocorythidae* Hsiung. V. A review of genera and species. Acta Protozool., 9, 23-39.
- Wolska M. 1971b: Studies on the family *Blepharocorythidae* Hsiung. VI. Phylogenesis of the family and the description of the new genus *Circodinium* gen. n. with the species *C. minimum* (Gassovsky, 1918). Acta Protozool., 9, 171-194.
- Wolska M. 1978: *Tripalmaria dogieli* Gass., 1918 (Ciliata, Entodiniomorphida). Structure and ultrastructure. Part I. Light-microscope investigations. Acta Protozool., 17, 13-20.
- Wolska M. 1980: *Tetratozum unifasciculatum* (Fiorent) (Ciliata, Entodiniomorphida). I. Somatic and adoral infraciliature. Acta Protozool., 19, 15-20.
- Wolska M. 1985: A study on the genus *Spirodinium* Fiorentini. Ciliata, Entodiniomorphida. Acta Protozool., 24, 1-11.

#### EXPLANATION OF PLATE I

*Pseudoentodinium elephantis*. Hematoxyline stained, the remaining ones silver impregnated

- 1: General view from the right side. Retracted cilia (arrow). 1000 ×
- 2: General view from the right side. 1100 ×
- 3: Same specimen, anterior part of the body. A view of the skeleton slats. 2600 ×
- 4: Left side of the ventral part of the adoral zone (arrow). 2000 ×
- 5: Same specimen. Right side of the ventral part of the adoral zone. 2000 ×
- 6: Adoral infraciliature viewed from the right side. Dorsal anterior part (D.a.p.). Dorsal posterior part (D.p.p.). Overturned cone is slightly seen; close by kinetosomes of "free cilia" (arrow). 2000 ×
- 7: Adoral zone viewed from the left side. Dorsal anterior part (D.a.p.). Dorsal posterior part (D.p.p.). 2000 ×
- 8: Same specimen. The lens focussed at "free cilia" (arrow) in the ventral right side. 2000 ×
- 9: General view of the left side and partially ventral side. A view of the top ends of cilia (arrow). 1800 ×



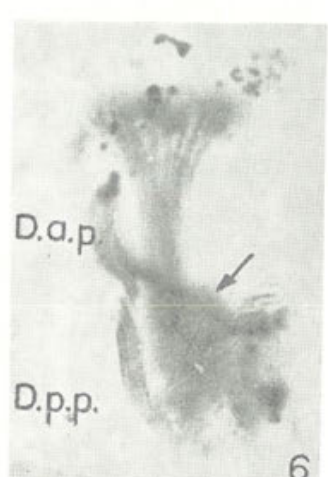
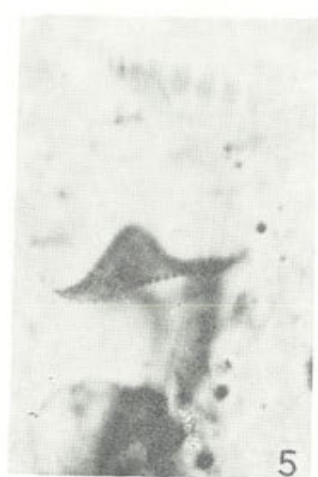
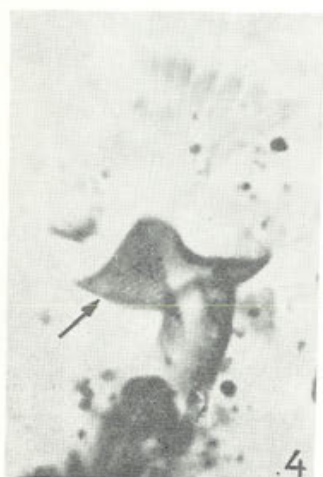
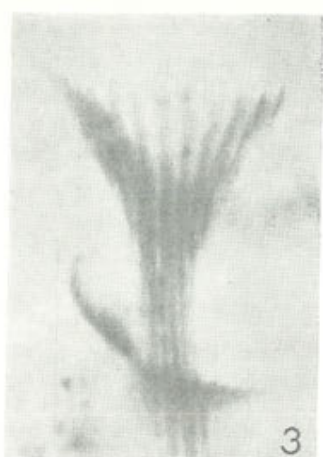
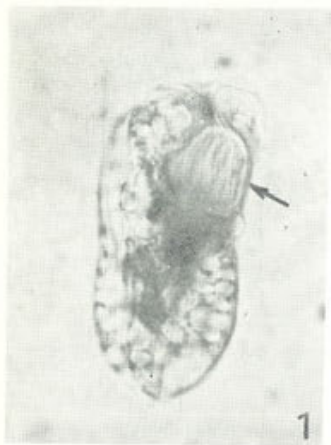

M. Wolska

auctor phot.





## A Preliminary Study of Induction of Macrostomal Development in *Tetrahymena vorax*, V<sub>2</sub>S Treated with d-Alpha-Tocopheryl Succinate

Dave C. LENNARTZ<sup>1</sup>

Department of Physiology and Cell Biology, University of Kansas,  
Lawrence, Ks. 66045 USA

Received on 4 July 1985

*Synopsis.* The transformation of the polymorphic ciliated protozoan *Tetrahymena vorax* V<sub>2</sub>S from a microstomatous (small-mouthed) bacteria-feeder into a macrostomatous (large-mouthed), cannibalistic carnivore can be induced by treating microstomes derived from axenic cultures with 10<sup>-4</sup>M (final concentration) d-alpha-tocopheryl succinate in 1% (v/v) ethanol for 12 h at pH 5.5 and 25°C. This treatment results in an inhibition of cell division, an increase in the length and number of the oral ciliature and a marked increase in the volume of the buccal cavity and the body due to the formation of a cytopharyngeal pouch in 28-40% of the organisms exposed to the vitamin. Groups of control organisms demonstrated that no more than 5% of the microstomatous populations transformed into macrostomes in the absence of tocopheryl succinate.

There are a number of species of ciliated protozoa with a polymorphic life history consisting of several interconnected phases. The life cycle of one such organism, *Tetrahymena vorax*, is characterized by the possession of a microstomal (small-mouthed) phase that adapts the organisms for a bacterial or particulate diet, a macrostomal (large-mouthed) phase that enables the ciliates to become cannibalistic carnivores, and an encysted stage wherein the organisms may reproduce. Organisms at any phase in the life cycle have the capability of transforming into either of the remaining phases through a series of morphogenetic changes that

---

<sup>1</sup> Address for Correspondence and Reprint Requests: Dave C. Lennartz, Ph. D. 2711 Colorado Avenue, Santa Monica California 90404, USA.

are inducible by appropriate changes in the environment as described by Buhse and Cameron (1968) and Corliss (1973).

The transformation of *Tetrahymena vorax* strain V<sub>2</sub>S from the microstomal form to the macrostomal form can be viewed as the structural and biochemical expression of an alternative morphogenetic pathway. The capacity to produce macrostomal forms in the presence of an appropriate inducer suggests that genomic expression can be used as means of adapting to short-term environmental changes.

The present work extends previous studies by Lennartz and Bovee (1980) and Lennartz (1982) on the use of d-alpha-tocopheryl as an inducer of macrostomal development by *Blepharisma americanum*. The primary purpose of this study is to demonstrate that d-alpha-tocopheryl induces macrostomal development in *T. vorax* V<sub>2</sub>S in a comparable manner, and to compare these results with other recent studies of macrostomal development by this species.

## Materials and Methods

### Organisms and Culture Conditions

The organism selected for this study, *Tetrahymena vorax* V<sub>2</sub>S, was obtained in axenic culture from the American Type Culture Collection (ATCC No. 30421). The microstomatous form was cultivated under axenic conditions in 2% (v/v) proteose peptone (Difco) medium with Chalkley's solution as the liquid component (Chalkley's solution contains 0.1 g NaCl, 0.004 g KCl, 0.006 g CaCl<sub>2</sub> per liter of double distilled water). Cultures were kept in darkness at 25 ± 0.1°C at a pH of 6.8-7.2 (optimal growth conditions for this strain).

### Induction of Macrostomal Development

Microstomatous *T. vorax* V<sub>2</sub>S were harvested from mass cultures and washed at least three times in Chalkley's solution. Washed ciliates were examined by light microscopy and organisms of approximately uniform size were selected by micropipette with the aid of a calibrated ocular micrometer. This step was taken to ensure that random variations in size would not contribute to macrostomal production, a possibility noted by Pierce et al. (1978) in their work on *Blepharisma*. Organisms selected for study were separated into the following treatment groups. Each group was comprised of three replicates consisting of 100 ciliates per replicate:

Group A: Untreated microstomatous organisms in Chalkley's solution at pH 6.8 and 25°C.

Group B: Untreated microstomatous organisms in Chalkley's solution at pH 5.6 and 25°C.



Group C: Microstomes exposed to 1% (v/v) ethanol in Chalkley's solution at pH 6.8 and 25°C.

Group D: Untreated microstomatous organisms in 2% proteose peptone at pH 6.8 and 25°C.

Group E: Untreated microstomatous organisms in 2% proteose peptone at pH 5.5 and 25°C.

Group F: Untreated microstomatous organisms exposed to  $10^{-4}$ M succinate at pH 5.5 and 25°C.

Group G: Microstomatous ciliates exposed to  $10^{-7}$ M d-alpha-tocopheryl succinate (ICN Pharmaceuticals, Cleveland, Ohio Lot No. 1091) at pH 5.5 and 25°C.

Group H: Microstomatous ciliates exposed to  $10^{-6}$ M d-alpha-tocopheryl succinate at pH 5.5 and 25°C.

Group I: Microstomatous ciliates exposed to  $10^{-5}$ M d-alpha-tocopheryl succinate at pH 5.5 and 25°C.

Group J: Microstomatous ciliates exposed to  $10^{-4}$ M d-alpha-tocopheryl succinate at pH 5.5 and 25°C.

The organisms from each group were observed hourly for signs of transformation over an 18-h period using an Olympus BHC microscope equipped with bright field or phase contrast optics. The number of organisms transformed was determined by direct visual counting of each sample.

## Results

The results of the present study are shown in Table 1. *Tetrahymena vorax* V<sub>2</sub>S transformed from the microstomal form (Pl. I 1) to the macrostomal form (Pl. I 2) through sequential changes in the oral ciliature and enlargement of the oral cavity to produce a cytopharyngeal pouch as described previously by B u h s e (1966 a, b).

Table 1

Results of macrostomal induction experiments with *Tetrahymena vorax* V<sub>2</sub>S

Treatment Group	% Macrostomes			Mean ± S.E.M.
A (Chalkley's at pH 6.8)	0	0	0	0.00
B (Chalkley's at pH 5.5)	1	2	0	1.00±0.06
C (1% ethanol at pH 5.5)	0	0	0	0.000
D (2% proteose peptone pH 6.8)	0	0	0	0.00
E (2% proteose peptone pH 5.5)	3	0	0	2.67±0.15
F (10 <sup>-4</sup> M succinate at pH 5.5)	0	0	0	0.00
G (10 <sup>-7</sup> M tocopheryl succinate)	5	3	10	6.00±0.21
H (10 <sup>-6</sup> M tocopheryl succinate)	8	11	9	9.33±0.09
I (10 <sup>-5</sup> M tocopheryl succinate)	20	14	18	17.33±0.18
J (10 <sup>-4</sup> M tocopheryl succinate)	35	28	40	34.33±0.35

All experiments started with microstomatous organisms and were done at 25°C. N = 100 ciliates per replicate (Total of 300 ciliates per group).

The results from control groups showed that the medium used for cultivating or manipulating the organisms had little or no capacity to induce macrostomal development in microstomatous organisms. In contrast, exposing microstomes to  $10^{-4}$  M d-alpha-tocopheryl succinate resulted in macrostomal development by up to 40% of the ciliates in 12 h. Exposure of microstomes to lower concentrations ( $10^{-1}$  M to  $10^{-5}$  M) of the vitamin required 12-18 h for the induction of macrostomal development. In contrast to the recent studies of Royals and Smith-Somerville (1984) the present results were obtained without prior heat-shock treatment.

### Discussion

The results of the present study show that d-alpha-tocopheryl induces macrostomal development by *T. vorax* V<sub>2</sub>S that is identical in all morphological details to the microstome—macrostome transformation induced by "stomatin" as described by Buhse (1967). The development of macrostomatous *T. vorax* following exposure to the vitamin is comparable to macrostomal development by *B. americanum* as described previously by Lennartz and Bovee (1980) and Lennartz (1982). The percentage of macrostomal development obtained in the present work is relatively low and may be attributable to the use of the succinate ester of d-alpha-tocopherol in most recent experiments of the type reported here. This form of the vitamin may not always dissociate completely under the conditions employed in the experiment (Henckel Corp., personal communication, 1984). The use of an unesterified tocopherol in these experiments might result in more effective macrostomal development. An alternative explanation for the moderate response of *T. vorax* V<sub>2</sub>S to the vitamin is based on the work of Williams (1961) that documents the regular occurrence of stable sublines of this strain. Slight variations in either the structure or the expression of the genome of these sublines could alter the degree of response of the organisms to an inducer such as tocopherol.

The findings of the present study have been confirmed independently by the recent work of Royals and Smith-Somerville (1984) who have been studying the effects of d-alpha-tocopheryl succinate and other substances on the induction of macrostomal development in *T. vorax* V<sub>2</sub>S. The significance of their observation that macrostomal development by *T. vorax* V<sub>2</sub>S in the presence of d-alpha-tocopheryl succinate proceeds only after heat-shock treatment of microstomatous organisms is not clear since this pretreatment was not required to obtain the present results. A plausible explanation for this difference is that the opti-



rum routine cultivation temperature for the subline of *T. vorax* V<sub>2</sub>S (25°C) was somewhat higher than that used by Ryals and Smith-Somerville (18-20°C), thereby obviating the need for heat shocks. The results of the present study also are consistent with the recent work of Butzel and Fischer (1983) that documented the induction of macrostomal development by *T. vorax* V<sub>2</sub>S with hypoxanthine and uracil.

The results of the present experiments, together with those of other studies on macrostomal development by *T. vorax* V<sub>2</sub>S and *B. americana*, suggests that the expression of the macronuclear genome may be controlled, in part, by the presence of one or more "molecular signals" in the environment. The recent study of Gulliksen et al. (1984) using 2-D gel electrophoresis to monitor protein synthesis in the oral apparatus of transforming *T. vorax* provides support for this hypothesis, since they show that certain proteins are synthesized following the introduction of the inducer "stomatin" that are not present prior to transformation.

#### ACKNOWLEDGEMENTS

The author wishes to thank Dr. Eugene C. Bovee for the use of laboratory space, equipment and supplies in support of this research. Therese Dietlin provided critical review of the work, and was helpful during the process of thinking about the significance of the results.

#### REFERENCES

- Buhse Jr. H. E. 1966a: Oral morphogenesis during transformation from microstome to macrostome and macrostome to microstome in *Tetrahymena vorax* strain V<sub>2</sub>, type S. *Trans. Am. Microsc. Soc.*, 85, 305-313.
- Buhse Jr. H. E. 1966b: An analysis of macrostome production in *Tetrahymena vorax* strain V<sub>2</sub>, type S. *J. Protozool.*, 13, 429-435.
- Buhse Jr. H. E. 1967: Microstome-macrostome transformation in *Tetrahymena vorax* strain V<sub>2</sub>, type S, induced by a transforming principle, stomatin. *J. Protozool.*, 14, 608-613.
- Buhse Jr. H. E. and Cameron I. L. 1968: Temporal pattern of macromolecular events during the microstome-macrostome cell transformation of *Tetrahymena vorax* strain V<sub>2</sub>S. *J. Exp. Zool.*, 169, 229-236.
- Butzel H. M. and Fischer J. 1983: The effects of purines and pyrimidines upon transformation in *Tetrahymena vorax*, strain V<sub>2</sub>S. *J. Protozool.*, 30, 247-250.
- Corliss J. O. 1973: History, Taxonomy, Ecology and Evolution of Species of *Tetrahymena*. In: *Biology of Tetrahymena* (ed. A. M. Elliott), Dowden, Hutchinson and Ross, Pennsylvania, p. 36-41.
- Gulliksen O., Løvlie A. and Kvammen L. 1984: Different polypeptides in two homologous cellular structures, the microstomal and macrostomal oral apparatus of *Tetrahymena vorax*. *Dev. Biol.*, 103, 511-516.
- Lennartz D. C. and Bovee E. C. 1980: Induction of macrostome formation in *Blepharisma americanum* (Suzuki, 1954) by d-alpha-tocopheryl succinate. *Trans. Am. Microsc. Soc.*, 99, 310-317.
- Lennartz D. C. 1982: Studies on antioxidant induced giantism and cannibalism

- of the ciliated protozoan, *Blepharisma americanum* (Suzuki, 1954). Doctoral Dissertation, University of Kansas. Diss. Abstr. 1981; Int B 1982; 42, p. 2657-2658.
- Pierce E., Isquith I. and Repak A. 1978: Quantitative study of cannibal-giantism in *Blepharisma*. Acta Protozool., 17, 493-501.
- Rvals P. E. and Smith-Somerville H. E. 1984: The effect of alpha-tocopheryl succinate on macrostome formation in *Tetrahymena vorax* strain V<sub>2</sub>S. J. Protozool., 31, 12A-13A.
- Williams N. E. 1961: Polymorphism in *Tetrahymena vorax*. J. Protozool., 8, 403-410.

#### EXPLANATION OF PLATE I

- 1: A microstomatous *Tetrahymena vorax* V<sub>2</sub>S untreated control
  - 2: An intermediate stage in the macrostomal development of *T. vorax* V<sub>2</sub>S following treatment with 10<sup>-4</sup>M d-alpha-tocopheryl succinate. The cytopharyngeal pouch (CP) is beginning to form
  - 3: A macrostomatous *T. vorax* V<sub>2</sub>S following exposure to 10<sup>-4</sup>M d-alpha-tocopheryl succinate for 10 h at 25°C. The cytopharyngeal pouch is conspicuous
- All photographs are shown at the same final magnification



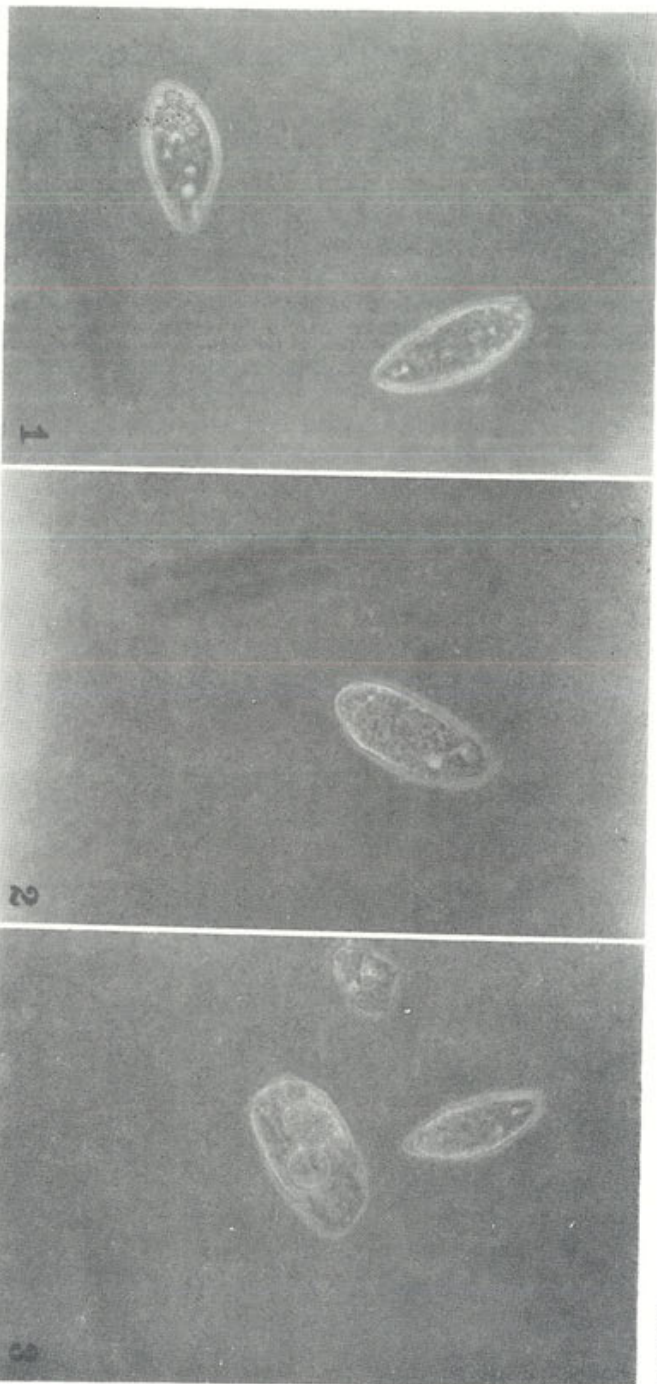

D. C. Lemartz

auctor phot.





## Recovery of Cytoskeletal and Motor Capacities by the Hyaline Blebs Produced by *Amoeba proteus*

Andrzej GRĘBECKI

Department of Cell Biology, Nencki Institute of Experimental  
Biology, ul. Pasteura 3, 02-093 Warszawa, Poland

Received on 4 November 1986

*Synopsis.* Abundant hyaline blebs are produced within several hours and during next two days by amoebae maintained at 27-30°C in Pringsheim medium buffered with HEPES at 7.5-8.5. Such blebs are stable and accumulate on the tail surface, if the cell keeps the motor polarity. They resist the intracellular pressure and do not open new ways for the outflow of endoplasm. Further uniform development of their area is impossible, except budding of second- and third-rank blebs at some discrete points. In such cases the primary blebs seem to pump their content into the secondary ones. That indicates that after the formation of a bleb of the initially fluid hyaloplasm, the cytoskeletal and contractile MF layer is probably reconstructed. This conclusion is complementary to the recent findings of other authors that fluorescein-labeled actin and myosin may repolymerize inside the hyaline layer. It is presumed that the hyaline frontal caps may be only as long devoided of the cytoskeletal and contractile capacities as they advance and are continuously supplied with a new, freshly separated hyaloplasm.

The advancing pseudopodia of *Amoeba proteus* form hyaline caps at their tips. The fluid nature of the hyaloplasm was admitted in the past by all major theories of amoeboid movement. Also our present ideas on the mechanism of locomotion of amoebae, expressed by the generalized cortical contraction theory (Grębecki 1981, 1982), are based on the presumption that the experimentally demonstrated relaxed condition of the advancing front of locomotion depends on the deficiency of cytoskeletal and contractile capacities of the hyaloplasm separating the MF layer from the plasma membrane in the tips of growing pseudopodia.

On the other hand, some earlier phenomenological data and most recent studies of the assembly and disassembly of the contractile appara-

tus of amoeba (Stockem et al. 1982, 1983 a, b, Hoffmann et al. 1984) indicate that the hyaloplasm cannot be always considered as a completely structureless inert fluid. The excellent examples of an abundant separation of the hyaloplasm and formation of stable hyaline blebs, which seem to recover the capability of resisting the intracellular hydrostatic pressure and to contract, were encountered in a series of experiments dealing with the influence of fibronectin on the adhesion and locomotion of *Amoeba proteus*. The objective of the present paper is to describe the behaviour of such blebs and re-discuss the question of cytoskeletal properties and contractility of the hyaloplasm.

## Materials and Methods

The *Amoeba proteus* cultures were grown in the standard Pringsheim medium and fed twice a week on *Tetrahymena pyriformis*. Experimental samples, starved for 2-3 days, contained 20-30 individuals in 0.1 ml of medium. They were kept for 3 days, at 27-30°C, under coverslip hold by glass spacers at 0.5 mm from the bottom slide and protected by a circular layer of the paraffin oil. The test medium contained, besides the usual components of the Pringsheim solution, 2.5 mM HEPES buffer at pH 7.5 or 8.5 and 200 or 500 µg/ml of fibronectin. The medium modifications in the controls are described in the Results.

The fibronectin was purified from human plasma according to the procedure of Vuento and Vaheri (1979) by Dr. H. Hörmann. It was a generous gift of Dr. H. Hörmann and Dr. T. Schreckenbach from the Max-Planck-Institut für Biochemie in Martiensried bei München. Other chemicals were made by commercial manufacturers. Some of them were kindly offered by Dr. W. Sachsenmaier (University of Innsbruck) and Dr. K. Kuroda (University of Osaka). The author wishes to express most vivid thanks to all of them.

All the observations were made and photomicrographs taken with a Biolar microscope equipped with DIC optics of the Pluta system. Some experiments were filmed on the 16 mm black-and-white ORWO material at 1 frame per second, with a combined Bolex and Robot equipment.

## Results

### Experimental Conditions

The gradual losing of motor polarity accompanied by the production of stable hyaline blebs occurred in *Amoeba proteus* cells which were tested for the influence of the fibronectin on their spreading over the glass surface and mode of locomotion. The expected effects of the fibronectin were rather equivocal. On the contrary, the production of hyaline



blebs and their further behaviour presented the features which appear relevant to some aspects of the motor mechanism.

The large majority of the present results and all the photomicrographs shown in Pl. I-V were provided by amoebae observed in the standard Pringsheim medium buffered with 2.5 mM HEPES at pH 7.5 or 8.5, in the presence of 200 or 500  $\mu\text{g/ml}$  of fibronectin, at 27-30°C. Later on, several control tests were carried out to evaluate the importance of the fibronectin and HEPES present in the medium, pH and temperature.

The production of stable hyaline blebs was not clearly affected by the fibronectin concentration varying within the range of 0, 10, 20, 50, 100, 200 and 500  $\mu\text{g/ml}$ . Substitution of 200 or 500  $\mu\text{g/ml}$  of the fibronectin by the same concentration of the bovine plasma albumin also failed to produce any reliable results.

After readjusting the ratio of the two components of the HEPES buffer to pH 9.5 (without changing any other conditions) the investigated phenomena were still induced, but some dead cells begin to appear within 1-2 h. At pH 6.5 and 5.5 the individuals producing stable hyaline blebs were less numerous, but still present in the samples. They occurred also in small numbers without HEPES, in the unbuffered Pringsheim medium (pH 6.8).

After 10-30 min of exposure to higher temperatures (35-40°C) the amoebae round up and produce, instead of individual blebs, a continuous ring of hyaloplasm around the cell periphery, as described earlier by Seravin (1966). The separation of hyaloplasm takes place during cooling the sample in room temperature (Grębecki, unpublished). On the other hand, the present results were irreproducible at the ordinary room temperatures. Within the temperature range between 18 and 25°C no appreciable changes in the abundance and distribution of the hyaline layer could be found, in spite of the presence of 200-500  $\mu\text{g/ml}$  fibronectin and 2.5 mM HEPES, at pH 7.5-8.5.

It is concluded that the moderate raise of the temperature, to 27-30°C, had the key role in producing the effects described in this study. The presence of HEPES and a moderate decrease of the  $\text{H}^+$  concentration (pH 7.5-8.5) were important as contributory factors. The presence of the fibronectin was probably irrelevant.

#### Formation of Hyaline Blebs and Blisters

The samples of 20-30 amoebae in the Pringsheim medium, with 200-500  $\mu\text{g/ml}$  fibronectin and 2.5 mM HEPES at pH 7.5-8.5, in the temperature of 27-30°C, were kept under a regular microscopic control for the first 8 h of the experiment and 16, 24 and 48 h later.

During the first 2 h many individuals lose normal orientation of locomotion and the usual unidirectional character of the endoplasmic streaming. The flow of endoplasm is from time to time reversed back to the tail and in the pseudopodia the forward and backward phases of streaming intermit. As a result, the macromorphological differences between the tail and the frontal part of amoebae gradually disappear. As well in the specimens which moved before in the orthotactic manner (Pl. I 1 a) as in the polytactic ones (Pl. I 1 b, c) the former tail may often be still identified, however, it is no more corrugated as in the normal locomoting amoebae, but as rounded and smooth as the frontal region. The number of such individuals increases with time and some of them may be recognized in the same shape and at the same place many hours later.

In most cases the loss of motor polarity and reversals of the endoplasmic flow lead to the formation of prominent hyaline blebs at the tips of all formerly advancing or retracting pseudopodia (Pl. I 2, 3). The discoordinated streaming of endoplasm is neither capable to transform some of them into normal advancing frontal caps nor provoke collapsing of the others. If sometimes it arrives to such amoeba to produce, for a brief period of time, a coordinated streaming as shown in Pl. I 2, the old hyaline blebs (black arrowheads) are never used as frontal caps of locomotion; the endoplasmic streaming is directed (white arrow) toward a newly formed frontal zone. Brief periods of coordinated streaming could be provoked in such bulbiform amoebae by local shading one cell region (the technique described by Grębecki 1980). Normally, most of them keep for a long time the unchanged bulbous shape (Pl. I 3).

Some others, probably more resistant individuals which never assumed the bulbous form or recovered from this state, manifest the unidirectional endoplasmic streaming with or without the effective locomotion (Pl. II 4). Small hyaline blebs are also formed by them, shift backwards along the lateral body walls (small arrowheads) together with the relative withdrawal of the ectoplasmic cylinder in respect of the posterior body pole, and eventually accumulate in the tail (large arrowheads). Abundant spherical or ellipsoid hyaline blebs (with a few granular inclusions inside) also cover, as bunches of grapes, the retracting lateral pseudopodia (Pl. II 5) which are eventually incorporated into the tail region. The backward movement of hyaline blebs along the lateral body walls and their final accumulation in bunches on the tail surface is particularly well pronounced in monotactic amoebae which withdraw their ectoplasmic layer in the form of a fountain (Pl. II 6).

The production of hyaline blebs gradually increases and after seven-



ral hours many individuals are deformed and densely covered with almost spherical blisters (Pl. III 7). Formation of such blisters is instantaneous and accompanied by local contractions of the cell periphery, leading to their partial or complete separation. The hyaline blebs terminating old pseudopodia also become more spherical at this stage, suggesting a contraction at their basis, along the granulo- and hyaloplasm separation line (Pl. IV 9).

At the next step the whole cells become perfectly spherical with a profusion of completely separated membrane vesicles in the surrounding medium (Pl. III 8). The vesicles appear in the light microscope to be built either of a pure hyaloplasm or contain only very little granulo- and hyaloplasm. They are stable for several hours. The share of spherical cells producing membrane vesicles progressively increases in the populations examined after 8, 16, 24 and 48 h of exposure to the tested conditions. Such cells, with the separated membrane vesicles, may be obtained almost immediately in large numbers by exposing amoebae in the HEPES buffered medium (pH 8.5) for 10-30 min to 35-40°C.

The individual variation of the sensitivity of amoebae to the conditions of present experiments is very important. Therefore all the stages: a simple loss of the motor polarity, accumulation of hyaline blebs in the tail region, bulbous forms with stable hyaline blebs and spheres producing membrane vesicles, are almost always found together, in varying proportions, in the same samples. The share of normal locomoting specimens declines, but they may sporadically occur up to the end of the experiment. The final stage of cell spherulation and separation of membrane vesicles may begin in some individuals after several hours but becomes very common on the 2nd and 3rd day of incubation. Eventually, the samples die out because of bursting of the spherulated cells.

#### Manifestation of Motor Capacities by the Old Hyaline Blebs

The hyaline blebs induced in the present experiments exhibit, at the moment of their formation, the same features as the hyaline frontal caps and hyaline blebs preceding the development of new pseudopodia in normal locomoting amoebae: (1) they arise in the "explosive" manner within 1-2 s (as calculated from the film records); (2) at the moment of their formation the contractions are seen in the neighbouring or more distant areas of the cell periphery; (3) the nascent blebs immediately assume hemispherical or almost spherical shapes, when arising on the former pseudopodial tips of bulbiform cells (Pl. I 2, 3), on retracting pseudopodia of locomoting individuals (Pl. II 5) or along the whole sur-

face of deformed amoebae (Pl. III 7). This indicates that, as commonly accepted for the untreated amoebae, the hyaloplasm at the moment of its separation from the granuloplasm is fluid, structureless and behaves passively. But on the other hand, the further behaviour of the stable hyaline blebs formed under the present conditions strongly indicates the recovery of some structural and functional properties.

When a bulbiform amoeba locally stimulated by shade forms a new large pseudopodium (Pl. IV 10) and the endoplasm steadily flows in one direction (black arrows), the bulbiform cell body assumes the role of the posterior region of a normal migrating individual, i.e., it contracts and is withdrawn. In spite of that, the endoplasm is never squeezed through the old hyaline blebs (white arrowheads), which keep their form relatively stable and are retracted uniformly with other parts of the cell periphery.

In amoebae which under present conditions kept (or recovered) their polarity and locomotion, sometimes unusually huge lobes of hyaloplasm are found around the tail extremity (Pl. IV 11). The film analysis demonstrated that such caudal lobes do not behave as effusions of a structureless fluid, but uniformly contract and withdraw as the normal tail (white arrowheads at the stages a and b). Only at a few discrete points the structure is probably broken (white open arrows in b) and drops of new hyaloplasm pour out. As a result (stage c), the large hyaline lobes gradually disappear and in their place several small hyaline blisters (black arrowheads) remain attached to the tail.

Another manifestation of the probable reconstruction of some cytoskeletal structures in the old hyaline blebs is their capacity to form secondary blebs, which arise by a localized efflux of new, apparently fluid hyaloplasm. This phenomenon is demonstrated in Pl. V 12 by a series of selected cinematographic pictures taken in the top view. The second-rank blebs are often produced in that way at some sites of the surface of primary blebs in bulbiform individuals (as indicated by the double arrowhead in Pl. I 3). At the extremities of retracted pseudopodia even three generations of successive hyaline blebs may be sometimes observed (single, double and triple arrowheads in Pl. V 13). Other film records, as that shown in Pl. V 14, demonstrate that the secondary blebs grow (white arrowheads) at the expense of the primary bleb which simultaneously decreases in size (note its changes relative to the position of the black arrowheads). This strongly suggests that the periphery of the old primary bleb recovered not only cytoskeletal properties but also the contractility and pumps the fluid content out, into the secondary blebs.



## Discussion

The absence of any structured components in the frontal hyaline caps and lateral hyaline layer of the proteus-group amoebae was admitted by all earlier theories of amoeboid movement. According to the authors and followers of classical tail contraction concepts (e.g., Mast 1926, Goldacre 1956, Rinaldi 1964 a, b) the hyaline represents the fluid endoplasmic matrix squeezed into the frontal cap through the "plasmage sheet" (= condensed MF layer at the granuloplasm-hyaloplasm border, according to the present state of knowledge). For the frontal contraction theory (Allen 1961) it is the synergetic fluid produced in the advancing pseudopodial tip by the endoplasm-ectoplasm conversion (Allen and Cowden 1962). The recent generalized cortical contraction theory (Grębecki 1982) postulates that the separation of the hyaloplasm in the front is the result of a local detachment of the cortical layer of microfilaments from the plasma membrane (Wehland et al. 1979, Grębecka and Hrebenda 1979, Stockem et al. 1982).

The view that the hyaloplasm is fluid and structureless was in a good agreement with: (1) commonly known fact that the hyaline caps and blebs arise almost instantly, within 1-2 s; (2) equally trivial observations that they assume hemispherical or bead-like shapes; (3) low dry mass content in the hyaline cap fluid, as calculated from the refractive index (Allen and Roslansky 1958); (4) the difficulty to discern in the hyaloplasm any continuous structures by light- and early electron-microscopic techniques (see the discussion of this point by Wohlfarth-Bottermann 1964). The capability of the fluid hyaloplasm to be almost freely filtered through the MF layer disengaged from the plasma membrane in the frontal zone is fundamental to our present concept of amoeboid movement (Grębecki 1981, 1982; Stockem et al. 1983 a, b), because it explains the drop of the hydrostatic pressure in the front, which is necessary to promote and control the endoplasmic streaming.

On the other hand, however, some other published and unpublished observations indirectly indicated that the hyaline layer, blebs and caps cannot be always considered as devoided of some cytoskeletal properties and contractility:

(1) In the first papers demonstrating that the contractile system in *Chaos chaos* and *Amoeba proteus* has the character of a peripheral filamentous cortex (Komnick and Wohlfarth-Bottermann 1965; Korohoda and Stockem 1975, 1976) its position was defined as corresponding to the lateral hyaline layer.

(2) Important hyaline zones are often found in the uroid region, between the plasma membrane and the granulooplasm, as demonstrated by DIC microscopy (Stockem 1970) and EM (Stockem et al. 1982). In contrast to the hyaline blisters arising in the anterior cell part, they do not open the way for the outflow of endoplasm. It is not very easy, even by the localized light-shade stimulation, to transform the former tail into a new front (Grębecki 1980) or induce a new pseudopodium on its surface (Kłopotcka 1982), in spite of the presence of hyaline zones in the uroid.

(3) The hyaline layer may be seen in the adhesive knobs attaching amoebae to the substrate of locomotion and developed by pseudopodia which catch extracellular particles (Grębecki, unpublished). It is hardly imaginable how a completely structureless hyaline could assure the necessary mechanical link between the cytoskeleton and the adhesion site.

(4) In contrast to the opinion of Mast (1932) that the inhibitory effects of light on the advancing pseudopodia depend on the granulooplasm border (the "plasmagel sheet"), Kłopotcka (unpublished) was able to inhibit or stimulate the advance of optically empty hyaline pseudopodia, respectively, by illuminating or shading their tips.

(5) In many small amoebae (e.g., in *Mayorellidae* — Bovee 1964) the clear hyaline pseudopodia are capable of bending, twisting and coiling.

The abundant and stable hyaline blebs produced by *Amoeba proteus* under the experimental conditions described in the present study clearly manifest the capacity of recovering some rigidity of their structure and contractility, which are apparently lacking at the moment of their formation. They arise almost instantly on the frontal and/or lateral cell surface, as it happens in the untreated amoebae, and their drop-like appearance is even more pronounced than in the normal individuals. Their formation is correlated with a general cortical contraction or (more often) with multiple violent local contractions along the cell periphery. In the second case the hyaline blebs appear between two (or more) neighbouring discrete contraction sites, exactly as in the experiments of Grębecka (1982) in which new hyaline caps were induced by two mechanical or two photic stimuli applied at a short distance from one another. Their arising was interpreted as probably resulting from loosening the cortical MF layer and its disengagement from the plasma membrane between the two contraction centres. In general, the phenomenology of the formation of hyaline blebs under present conditions corroborates the view discussed above that the hyaloplasm, at the moment of its separation from the granulooplasm, is a structureless fluid filtered through the MF layer.



But this conclusion cannot be applied to the further behaviour of the hyaline blebs observed in the present experiments. It seems obvious that some more or less rigid structure must gradually develop along their periphery (the recovery of cytoskeletal properties), because: (1) they keep relatively stable size and shape, instead of swelling and opening a way to the outflow of endoplasm, when a bulbiform cell with many old hyaline caps contracts either spontaneously (Pl. I 2) or stimulated by light-shade difference (Pl. IV 10); (2) large hyaline lobes sometimes appearing around the uroid fail to grow more in size when the granulo-plasm of the tail contracts and withdraws (Pl. IV 11 a, b); (3) in general, a further development of an old hyaline layer or bleb is impossible by a uniform expansion of its area, but only by "budding" at some discrete sites which leads to the production of second-rank or even third-rank blebs (Pl. I 3 and V 13).

The recovery of the contraction capacity by the stabilized periphery of old hyaline layer and blebs is strongly suggested by: (1) the uniform decrease in size and retraction of the hyaline lobes sometimes surrounding the uroid under the present experimental conditions (Pl. IV 11); (2) in particular by the apparent pumping of the content of a primary hyaline bleb into the secondary ones (Pl. V 14).

The present results offer an explanation why the hyaline zones found in the uroid never produce new pseudopodia (Stockem et al. 1982). They are not locally produced in the tail region, but arise in the anterior cell part as lateral blebs or caps of lateral pseudopodia, exactly follow the relative movement of the principal ectoplasmic cylinder of amoeba (Grębecki 1984, 1985) and consequently accumulate in the tail, as observed in the present experiments (Pl. II 4, 6). This means that they are not built of the freshly filtered hyaline fluid but of the old stabilized and contractile hyaloplasm.

The reconstruction of the cytoskeletal and contractile MF cortex in the hyaline blebs could not be yet directly demonstrated by electron microscopy, even with the most perfected fixation techniques, though it has been postulated (Stockem et al. 1982). But the most recent applications of fluorescent analog and immunochemical techniques to the study of *A. proteus* prove that it is not a pure speculation. In the procaine-treated and pinocytosing cells, fixed and stained with anti-actin or anti-myosin antibodies, two layers of condensed contractile proteins are revealed: one as usually along the granulo-plasm-hyaloplasm border and the second on the hyaline territory just beneath the plasma membrane (Stockem et al. 1983 b). In small and completely hyaline pseudopodia of living amoebae the microinjected fluorescent muscle actin polymerizes under the frontal membrane and depolymerizes when it retreats (Stockem et al. 1983 a). It was demonstrated with the same



technique that in amoebae pretreated with procaine, puromycin and DNP the strongly fluorescent original MF layer detaches from the plasma membrane, the fluorescence of the separated hyaloplasm is initially weak and diffuse, but afterwards it condenses beneath the plasma membrane in the form of a second fluorescent actin layer (Hoffmann et al. 1984). It may be concluded from these observations that the hyaline is really fluid at the moment of its filtration and formation of the bleb, but in older blebs the reconstruction of the peripheral microfilamentous cortex is an actually demonstrated fact. From that point of view the present observations demonstrating the recovery of cytoskeletal and contractile capacities of the old hyaline blebs are strictly complementary to the recent data provided by the fluorescence techniques.

The reconstruction of the microfilamentous cytoskeleton in the hyaloplasm is probably possible because only the polymerized actin is retained by the pre-existing MF layer during the separation of both cytoplasmic fractions, whereas the G-actin penetrates onto the hyaline territory, as postulated by Gawlitta et al. (1980) on the basis of the behaviour of fluorescein-labeled actin injected into the locomoting amoebae.

It would be very important to learn how long takes the reconstruction of a new contractile cytoskeleton inside the hyaloplasm. Some light-microscopic observations suggest that the process may be very quick: (1) as commonly known, during normal locomotion, an advancing hyaline front may be transformed within a few seconds into a retracting one; (2) also a few seconds of arresting the endoplasmic streaming by counterpressure are sufficient to induce the contraction of a frontal cap (Grębecka 1980); (3) the same is produced by a localized light stimulus within about 5 s (Grębecki and Kłopotcka 1981); (4) in amoebae recovering from a mild thermic shock (the method of Seravin 1966), within their enormous hyaloplasm layer, the consecutive sheets are often seen to detach from the plasma membrane and rejoin the granuloplasm, at the frequency of 5-10 s (Grębecki, unpublished).

In general, it should be concluded that the hyaloplasm may be considered as a passively behaving structureless fluid only at the moment of its separation. The absence of any important cytoskeletal and contractile capabilities of the frontal zones is one of the basic presumptions of our present concepts of the mechanism of amoeboid movement (Grębecki 1981, 1982; Stockem et al. 1983 a, b). It corroborates well with the fact that just in the active fronts the fresh hyaloplasm is still produced in the tip, whereas the older one is left behind with the reconstructed rim of the ectoplasmic tube. On the other hand, the prob-



ably very easy recovery of the cytoskeletal and contractile properties by the hyaline frontal caps, allows the front to modulate or obstruct the endoplasm outflow in the former direction and then reorient the movement of the whole cell.

## REFERENCES

- Allen R. D. 1961: A new theory of ameboid movement and endoplasmic streaming. *Exp. Cell Res.*, (Suppl.), 8, 17-31.
- Allen R. D. and Cowden R. R. 1962: Syneresis in ameboid movement: Its localization by interference microscopy and its significance. *J. Cell Biol.*, 12, 185-189.
- Allen R. D. and Roslansky J. D. 1958: An anterior-posterior gradient of refractive index in the ameba and its significance in ameboid movement. *J. Biophys. Biochem. Cytol.*, 4, 517-524.
- Bovee E. C. 1964: Morphological differences among pseudopodia of various small amoebae and their functional significance. In: *Primitive Motile Systems in Cell Biology* (eds. R. D. Allen and N. Kamiya), Academic Press, 189-219, New York and London.
- Gawlitta W., Stockem W., Wehland J. and Weber K. 1985: Organization and spatial arrangement of fluorescein-labeled native actin, microinjected into normal locomoting and experimentally influenced *Amoeba proteus*. *Cell Tiss. Res.*, 206, 181-191.
- Goldacre R. J. 1956: The regulation of movement and polar organization in amoeba by intracellular feedback. In: *Proc. 1st Intern. Congr. Cybernetics*, Gauthier-Villars, 715-725, Paris.
- Grębecka L. 1980: Reversal of motor polarity of *Amoeba proteus* by suction. *Protoplasma*, 102, 361-375.
- Grębecka L. 1982: Local contraction and the new front formation site in *Amoeba proteus*. *Protistologica*, 18, 397-402.
- Grębecka L. and Hrebenda B. 1979: Topography of cortical layer in *Amoeba proteus* as related to the dynamic morphology of moving cell. *Acta Protozool.*, 18, 493-502.
- Grębecki A. 1980: Behaviour of *Amoeba proteus* exposed to light-shade difference. *Protistologica*, 16, 103-113.
- Grębecki A. 1981: Effects of localized photic stimulation on amoeboid movement and their theoretical implications. *Eur. J. Cell Biol.*, 24, 163-175.
- Grębecki A. 1982: Supramolecular aspects of amoeboid movement. In: *Progress in Protozoology. Proc. VI Intern. Congr. Protozool.*, part I, 117-130, Warszawa.
- Grębecki A. 1984: Relative motion in *Amoeba proteus* in respect to the adhesion sites. I. Behaviour of monotactic forms and the mechanism of fountain phenomenon. *Protoplasma*, 123, 116-134.
- Grębecki A. 1984: Relative motion in *Amoeba proteus* in respect to the adhesion sites. II. Ectoplasmic and surface movements in polytactic and heterotactic amoebae. *Protoplasma*, 127, 31-45.
- Grębecki A. and Kłopotcka W. 1981: Functional interdependence of pseudopodia in *Amoeba proteus* stimulated by light-shade difference. *J. Cell Sci.*, 50, 245-258.
- Hoffmann H. U., Stockem W. and Gruber B. 1984: Dynamics of the cytoskeleton in *Amoeba proteus*. II. Influence of different agents on the spatial organization of microinjected fluorescein-labeled actin. *Protoplasma*, 119, 79-92.
- Kłopotcka W. 1982: Intracellular factors influencing the direction of new pseudopodia produced by *Amoeba proteus*. *Protistologica*, 18, 389-396.
- Komnick H. and Wohlfarth-Bottermann K. E. 1965: Das Grundplasma und die Plasmafilamente der Amöbe *Chaos chaos* nach enzymatischer Behandlung der Zellmembran. *Zeitschr. Zellforsch.*, 66, 434-456.

- Korohoda W. and Stockem W. 1975: On the nature of hyaline zones in the cytoplasm of *Amoeba proteus*. *Microsc. Acta*, 77, 129-141.
- Korohoda W. and Stockem W. 1976: Two types of hyaline caps, constricting rings and the significance of contact for the locomotion of *Amoeba proteus*. *Acta Protozool.*, 15, 179-185.
- Mast S. O. 1926: Structure, movement, locomotion and stimulation in *Amoeba*. *J. Morphol.*, 41, 347-425.
- Mast S. O. 1932: Localized stimulation, transmission of impulses, and the nature of response in *Amoeba*. *Physiol. Zool.*, 5, 1-15.
- Rinaldi R. A. 1964a: Pictographs and flow analysis of the hyaline cap in *Chaos chaos*. *Protoplasma*, 58, 603-620.
- Rinaldi R. A. 1964b: The plasmagel sheet of *Amoeba proteus*. *Protoplasma*, 59, 480-484.
- Seravin L. N. 1966: Amoeboid locomotion. I. Arrest and resumption of the amoeboid locomotion under some experimental conditions (Russian with English summary). *Zool. Zh.*, 45, 334-341.
- Stockem W. 1970: Untersuchungen mit dem Differential-Interferenz-Kontrast über Morphologie und Cytosen von *Amoeba proteus*. *Mikroskopie*, 24, 332-344.
- Stockem W., Hoffmann H. U. and Gawlitta W. 1982: Spatial organization and fine structure of the cortical filament layer in normal locomoting *Amoeba proteus*. *Cell Tiss. Res.*, 221, 505-519.
- Stockem W., Hoffmann H. U. and Gruber B. 1983a: Dynamics of the cytoskeleton in *Amoeba proteus*. I. Redistribution of microinjected fluorescein-labeled actin during locomotion, immobilization and phagocytosis. *Cell Tiss. Res.*, 232, 79-96.
- Stockem W., Naib-Majani W., Wohlfarth-Bottermann K. E., Osborn M. and Weber K. 1983b: Pinocytosis and locomotion of amoebae. XIX. Immunocytochemical demonstration of actin and myosin in *Amoeba proteus*. *Eur. J. Cell Biol.*, 29, 171-178.
- Vuento M. and Vaheri A. 1979: Purification of fibronectin from human plasma by affinity chromatography under non-denaturing conditions. *Biochem. J.*, 183, 331-337.
- Wehland J., Weber K., Gawlitta W. and Stockem W. 1979: Effects of the actin-binding protein DNAase I on cytoplasmic streaming and ultrastructure of *Amoeba proteus*. An attempt to explain amoeboid movement. *Cell Tiss. Res.*, 199, 353-372.
- Wohlfarth-Bottermann K. E. 1964: Cell structures and their significance for amoeboid movement. *Int. Rev. Cytol.*, 16, 61-131.



## EXPLANATION OF PLATES I-V

Behaviour of the hyaline blebs produced at 27-30°C in 2.5 mM HEPES  
at pH 7.5-8.5 (Scale bars: 50 µm)

- 1: Loss of motor polarity by an orthotactic individual after 2 h of incubation (a) and by polytactic specimens after 2 h (b) and 4 h (c). Note the surface of the tail (T) becoming as smooth as the front (F)
- 2: Two motion stages (a and b) of a bulbiform amoeba with numerous hyaline blebs (black arrowheads) at the tips of former pseudopodia, which spontaneously produced a coordinated endoplasmic streaming (white arrow) in a new direction (4 h of incubation)
- 3: A motionless bulbiform specimen after 24 h of incubation, with many old hyaline blebs (arrowheads). Note the budding of a secondary bleb (double arrowhead)
- 4: A polytactic amoeba (6 h of incubation) accumulating the hyaline blebs in the tail region (large arrowheads in a). Note the new blebs gradually approaching the tail along the lateral body walls (small arrowheads). A larger magnification of the tail of the same specimen, shown in b
- 5: A bunch of grape-like hyaline blisters accumulated on a retracting pseudopodium (6 h of incubation)
- 6: Two stages (a and b) of accumulation of the hyaline blebs (arrowheads) in the tail of a monotactic amoeba which manifested the fountain movement and transported the blebs backwards (4 h incubation)
- 7: Two magnifications (a and b) of an individual which after 24 h of incubation produced hyaline blisters over the whole surface by multiple local contractions of the peripheral cell layer
- 8: Three magnifications (a-c) of a cell which after 24 h became spherical and separated many hyaline-filled membrane vesicles
- 9: An old, almost round, hyaline bleb on the tip of a former pseudopodium of a bulbous individual (24 h incubated) with a separation furrow (arrows) along the granuloplasm-hyaloplasm borderline
- 10: Two motion stages (a and b) of a bulbiform specimen which, after 8 h incubation period, has been stimulated by localized shade (out of the field of view) to produce unidirectional streaming of the endoplasm (black arrows). Note the retraction of the main cell body and the stability of the hyaline blebs (white arrowheads)
- 11: The tail of an individual incubated 6 h, with unusually huge hyaline lobes which are uniformly retracted (large white arrowheads in a-b). Small secondary hyaline blisters protrude in some places (white open arrows in b) and at a later stage replace the former lobes (small black arrowheads in c)
- 12: Five motion stages (a-e) of a hyaline bleb filmed from the top (note the granular core in its centre) producing a secondary bleb on its surface (4 h exposure)
- 13: A primary hyaline bleb (single arrowheads) which produced the second-rank (double arrowheads) and third-rank (triple arrowhead) blebs, on the tip of a retracting pseudopodium after 24 h of incubation
- 14: Three motion stages (a-c) of a primary hyaline bleb which apparently contracted (black arrowheads) and pumped its content into the secondary blebs (white arrowheads). The position of all arrowheads is kept constant in respect to the centre of the primary bleb. Filmed after 6 h of incubation





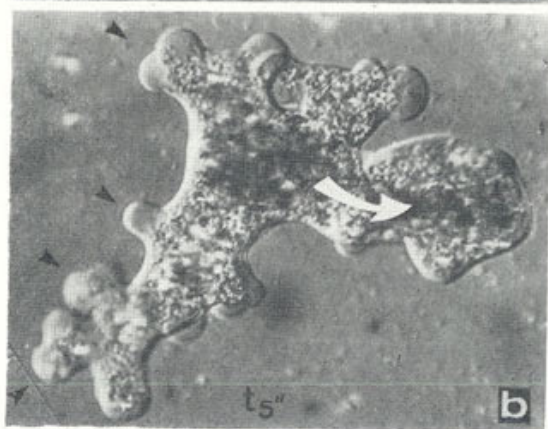
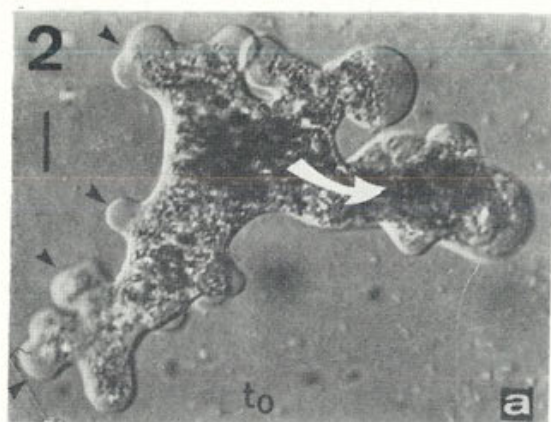
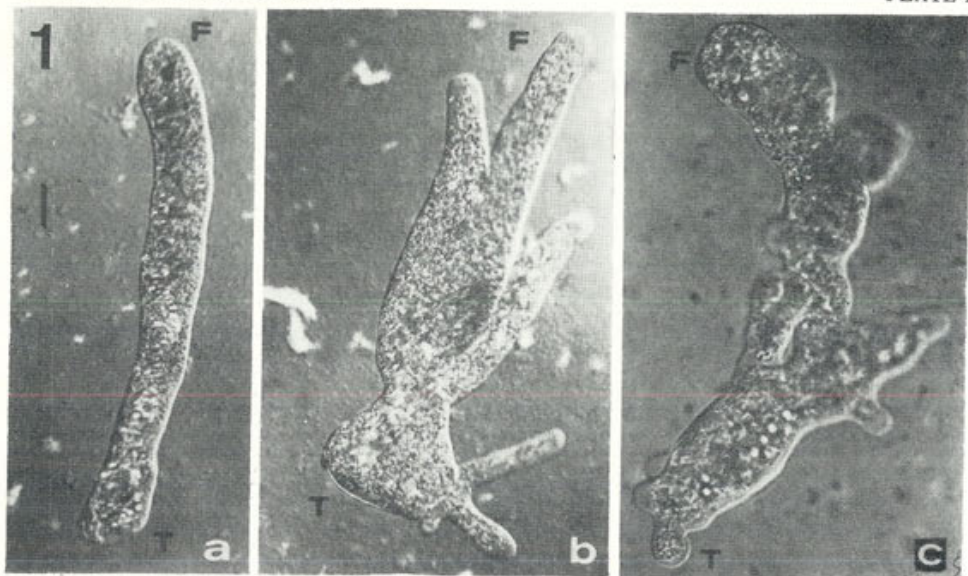

A. Grębecki

auctor phot.

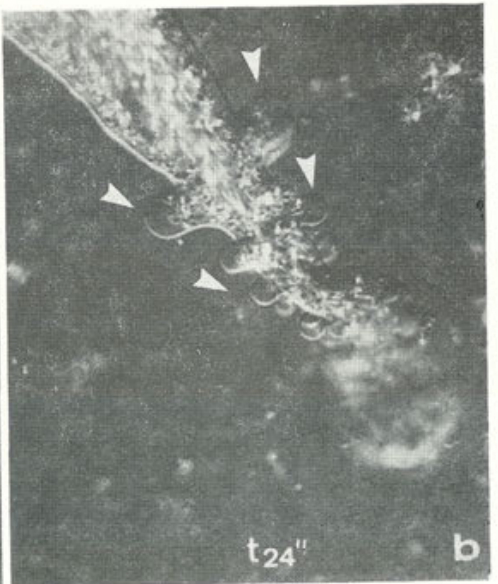
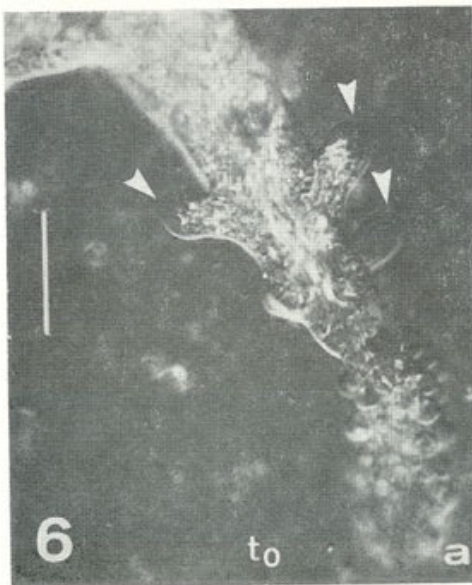
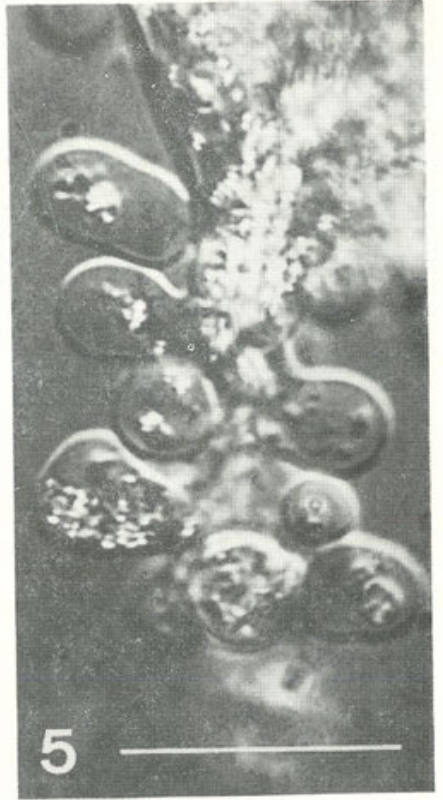
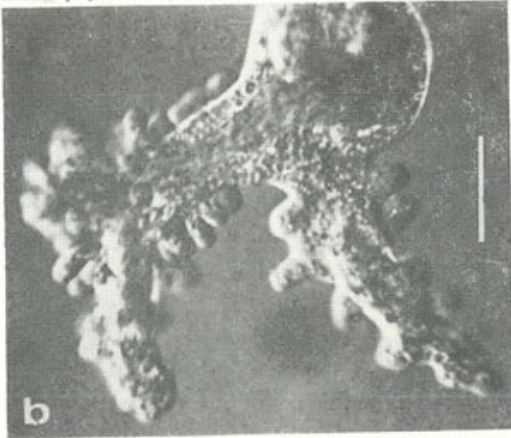
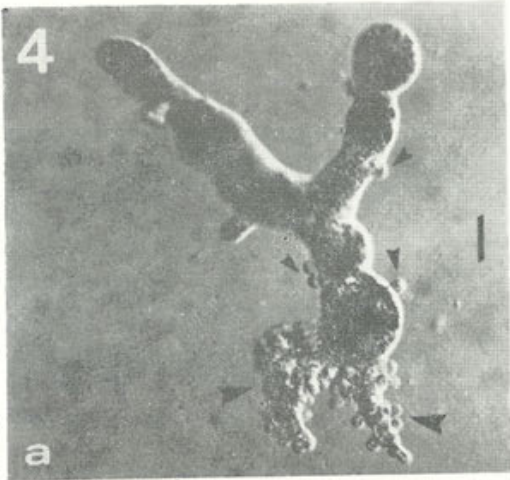



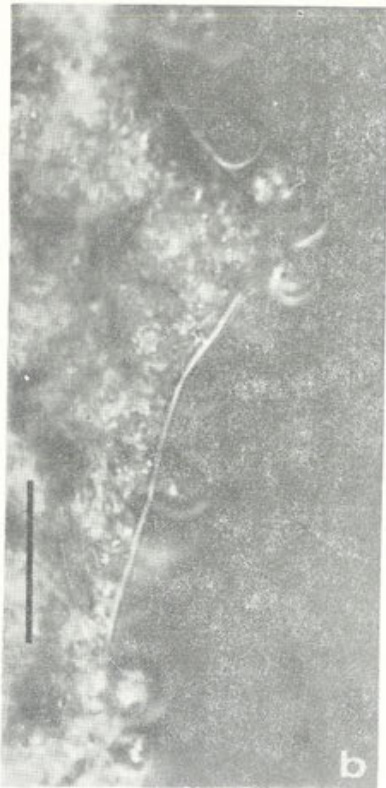
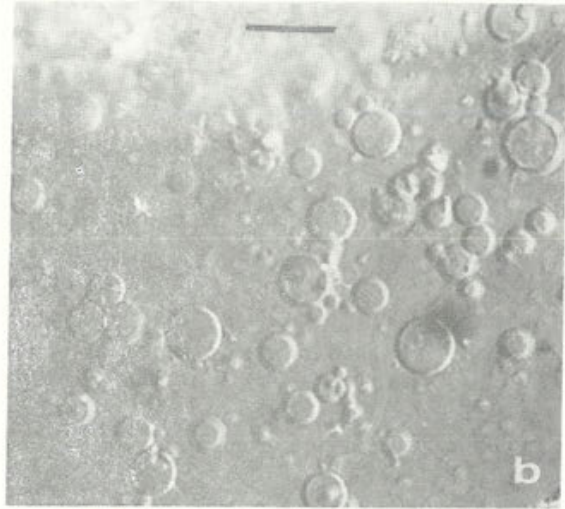
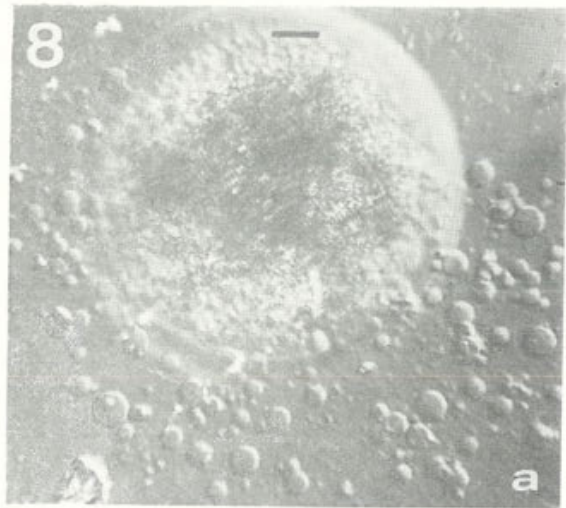
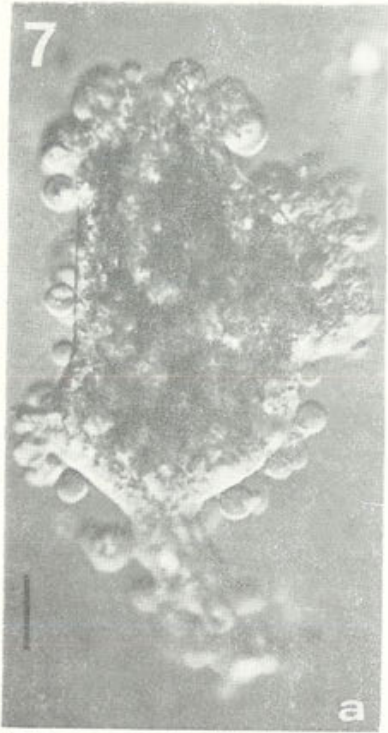

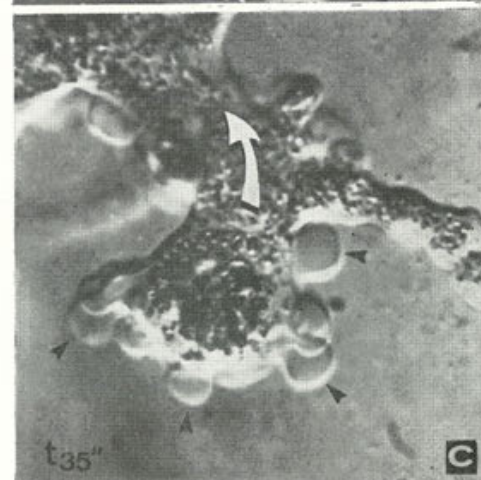
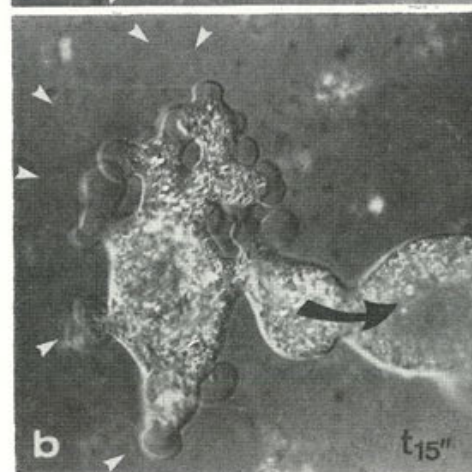
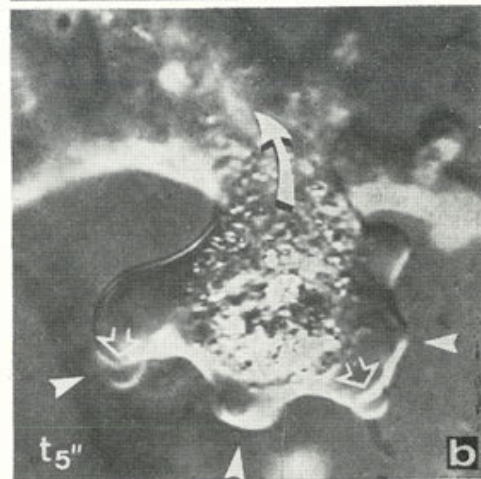
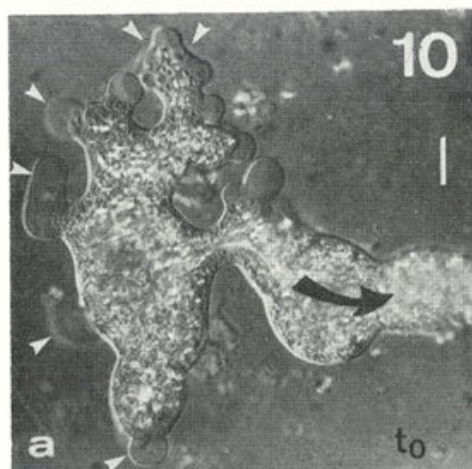
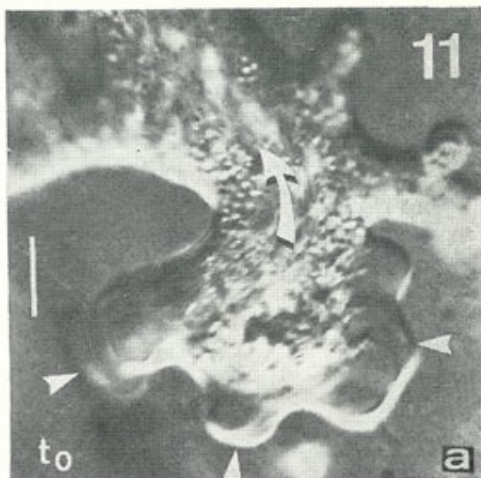
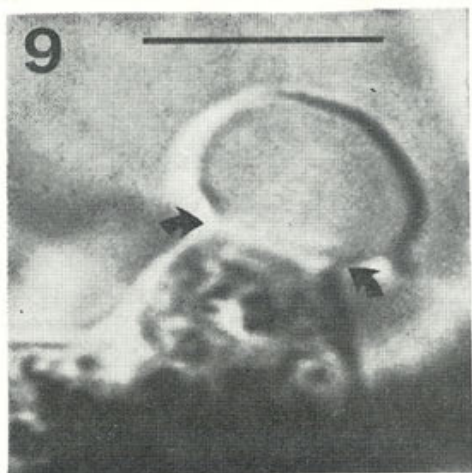

A. Grębecki

auctor phot.



## Effect of $\beta$ -receptor Antagonist Dichloroisoproterenol on *Paramecium* Endocytosis

Elżbieta WYROBA

Department of Cell Biology, Nencki Institute of Experimental Biology,  
Pasteura 3, 02-093 Warszawa, Poland

Received on 4 November 1985

*Synopsis.* Inhibition of endocytosis in long-term starved *Paramecium* evoked by pre-exposure to dichloroisoproterenol (DCI) was studied. The effect of DCI was dose-dependent and not related to the cells age and size of the particles to be ingested. The complete blockade of digestive vacuoles formation was observed at 55-70  $\mu$ M DCI. Inhibition was shown to be reversible by washing the cells: ciliates pre-exposed to 17.5  $\mu$ M and 70  $\mu$ M DCI reached 60% and 25% of control phagocytic activity, respectively, in 2 h following removal of drug. Ultrastructural observations carried out on DCI-pretreated cells indicate that intracellular membrane pool indispensable for phagosome formation has not been impaired by drug action.

It has been just demonstrated by us that dichloroisoproterenol (DCI) — an antagonist of beta-receptors (Moran and Perkins 1958) may be used as a drug blocking endocytosis in *Paramecium aurelia* as proved in the experiments carried out in the light, fluorescence and electron microscopy.

The following processes have been observed:

- (1) latex particles uptake;
- (2) internalization of cycloheptaamylose dansyl chloride complex in the course of fluorescent labelling of cell surface (Giordano et al. 1985);
- (3) endocytosis of ruthenium red occurring during simultaneous staining and fixation of long-term starved cells (Wyroba 1984). All these endocytic processes have been completely inhibited by pretreatment of the cells with dichloroisoproterenol (Giordano et al. 1985, Wyroba 1986).

The aim of present study was to characterize the DCI inhibition process and correlate the physiological observations on endocytosis blockade with the ultrastructural approach since it has been shown that phagosome membrane in *Paramecium* — and in the other ciliates (Kloetzel 1974) — is derived from the pool of discoidal vesicles located in the cytopharyngeal region of the cell (Allen 1974). In the series of the elegant studies it has been also shown that these vesicles are involved in membrane recycling: the spent vacuole membrane at the cytoproct is returned directly to the cytopharynx along the cytopharyngeal microtubular ribbons in the form of discoidal bodies (Allen and Fok 1980, Allen 1984). Thus searching for this membrane pool in ciliates which endocytic activity is completely blocked by dichloroisoproterenol may provide some information on the drug action.

### Materials and Methods

*Paramecium octaurelia*, strain 299s maintained in the axenic culture (Soldo et al. 1966) was used. Four-seven day-old cultures were collected by centrifugation at 600 g and washed twice with MSS solution (Soldo and Wagtendonk 1967) followed by rinsing with 0.005 M Tris-HCl buffer pH 7.6 containing 0.001 M CaCl<sub>2</sub>. Collecting and washing of the ciliates was carried out in aseptic conditions. The cells were then starved in sterile Tris buffer at 18°C. Dichloroisoproterenol (DCI — Sigma, USA) pretreatment (for 20 min) and Dow Latex (Serva FRG; DL — 0.79 µm in diameter) particles uptake (30 min at room temperature) was performed as described previously (Giordano et al. 1985).

To check the effectiveness of DCI inhibition of the phagocytic activity depending on the type and size of particles ingested the following microbeads have been tested:

diameter (µm)	type of spheres
0.52	Polystyrene latex (Serva, FRG)
0.79	Polystyrene latex (Serva, FRG)
0.95	Dyed polystyrene monodispersed latex (Polysciences, USA)
1.72	Fluoresbrite-fluorescent monodisperse carboxylated microspheres (Polysciences, USA)
3.0	Polybead-carboxylate monodisperse microspheres (Polysciences, USA)
4.5	Fluoresbrite-fluorescent monodisperse carboxylated microspheres (Polysciences, USA)

The uptake of these particles was monitored under the same experimental conditions as used in the case of standard (0.79 µm in diameter) latex beads, with detection of the fluorescent ones in fluorescent microscope.

To test the recovery of phagocytic activity, cells exposed to different concentrations of DCI subsequent to washing procedure were left in buffer and at various time points aliquots of the ciliates were tested for latex uptake. Viability and physiological state of the cells were microscopically checked prior to, and during the experiment.

Electron microscopic observations on DCI-treated (3 min action of drug followed by fixation — staining procedure) and DCI-pretreated cells stained with ruthe-



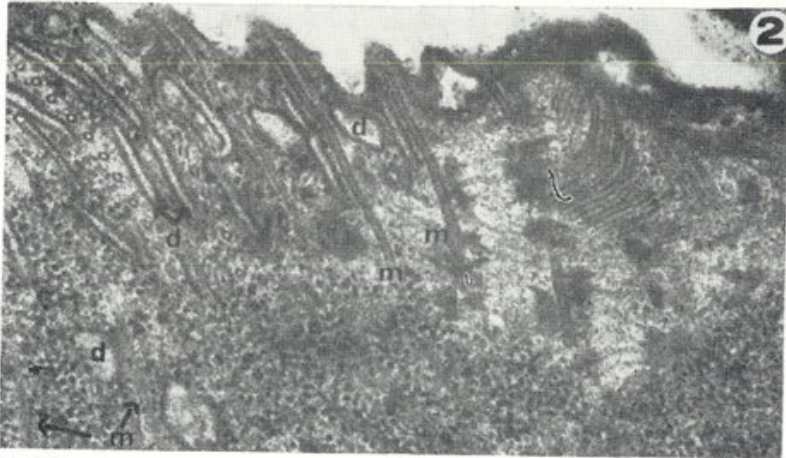
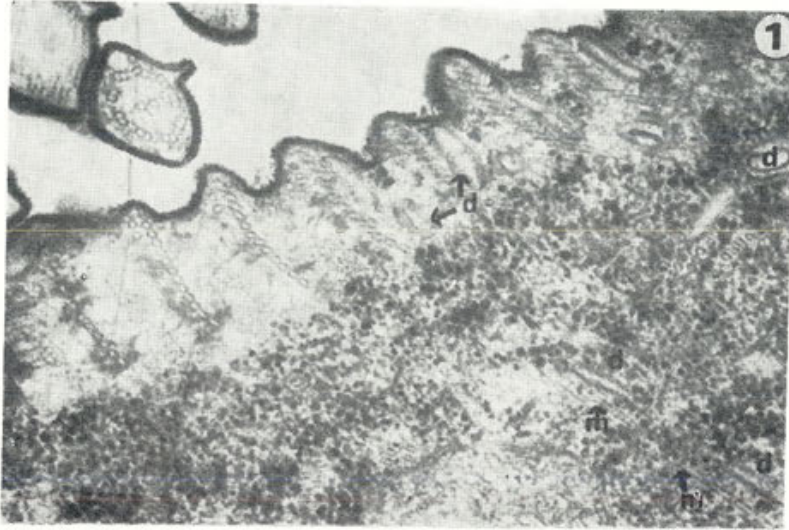

E. Wyroba

auctor phot.



E. Wyroba

auctor phot.



nium red were carried out as described previously (Wyroba and Brutkowska 1978) in parallel experiments. Thus cells overviewed in electron microscope (JEM 100B) have been the aliquots of the samples used in inhibition test.

Control cells were processed in the same manner with buffer added instead of DCI.

### Results

As it has been shown in previous experiments (Giordano et al. 1985) DCI added simultaneously with particles to be ingested inhibited almost completely the phagocytic activity of *Paramecium* cells whereas pre-exposure to this drug (applied in the same concentration) evoked a complete cessation of digestive vacuole formation. Thus to characterize the DCI action, the pretreated cells have been examined. The results

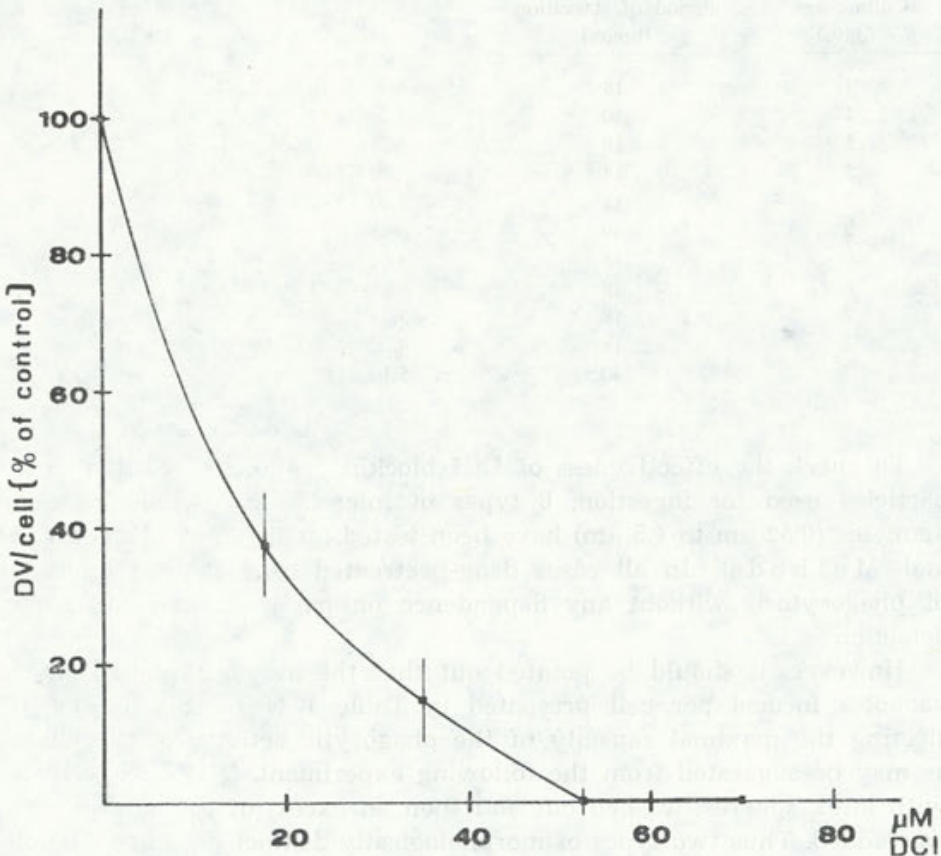

Fig. 1. Effect of DCI on digestive vacuole formation. The average value of the digestive vacuoles (DV) formed per cell obtained from  $\geq 50$  ciliates was expressed as a percentage of DV number in the controls carried out for each experiment. Mean number of 3 experiments

presented below concern about 5000 of cells in which the number of digestive vacuoles was enumerated.

Inhibition of digestive vacuole formation evoked by pre-exposure of the long-term starved cells to DCI was dose-dependent (Fig. 1). At 10 and 20  $\mu\text{M}$  DCI, number of vacuoles formed was reduced by 40% and 65%, respectively, as compared with control. A complete cessation of phagocytic activity was observed above 55  $\mu\text{M}$  DCI. Effect of DCI was not dependent on cells age when the long-term starved ciliates have been analyzed (Table 1).

Table 1

DCI evoked inhibition of phagocytosis in relation to cells age and period of starvation — the average number of digestive vacuoles per cell. Uptake of latex particles (0.79  $\mu\text{m}$  in diameter)

Culture age (days)	Period of starvation (hours)	Control	DCI-pretreated (70 $\mu\text{M}$ )
4	18	4.66 $\pm$ 2.46	0
4	40	4.64 $\pm$ 2.95	0
5	18	5.80 $\pm$ 3.00	0
5	18	5.30 $\pm$ 2.69	0
5	18	5.40 $\pm$ 3.70	0
5	40	4.46 $\pm$ 3.39	0
6	18	4.02 $\pm$ 2.10	0
6	18	4.26 $\pm$ 2.82	0
7	18	5.29 $\pm$ 2.37	0.06
7	18	4.60 $\pm$ 2.08	0
7	40	5.10 $\pm$ 3.05	0

To check the effectiveness of DCI blocking action in relation to the particles used for ingestion, 6 types of microbeads of wide range of diameter (0.52  $\mu\text{m}$  to 4.5  $\mu\text{m}$ ) have been tested (as listed in Materials and Methods). In all cases drug-pretreated cells showed inhibition of phagocytosis without any dependence on particles used for uptake detection.

However, it should be pointed out that the average number of the vacuoles formed per cell presented in Table 1 was probably not reflecting the maximal capacity of the phagocytic activity of the ciliates as may be suggested from the following experiment. The cells were fed with latex spheres, washed out and then an excess of carmine particles was added. Thus two types of morphologically distinct digestive vacuoles could be produced and observed microscopically. Combined total number of digestive vacuoles was twice higher than the average obtained with one type of particles ingested.

The effect of dichloroisoproterenol was reversible when cells have



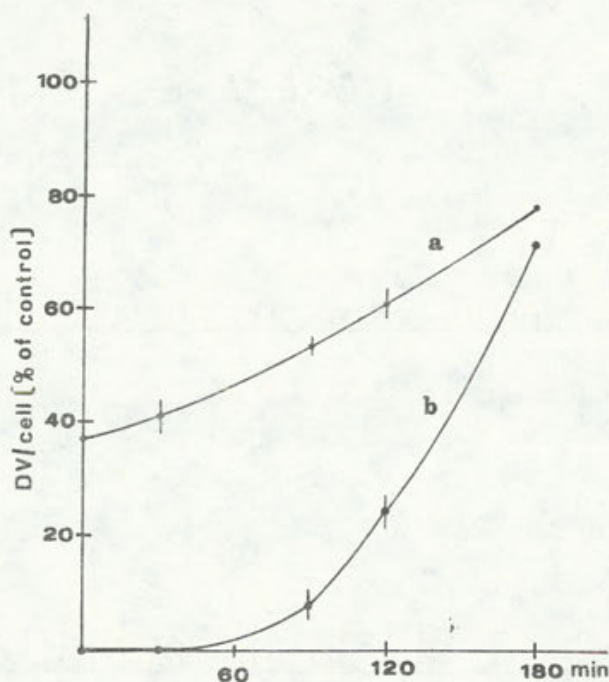

Fig. 2. Recovery of digestive vacuoles formation in DCI-pretreated cells. For each time point digestive vacuoles formed in  $\geq 50$  cells were scored and the average of DV per cell was expressed as a percentage of DV number in the controls carried out in the same time point. A mean number of 3 experiments. a — 17.5  $\mu\text{M}$  DCI, b — 70  $\mu\text{M}$  DCI

been washed and transferred to the buffer (Fig. 2). Recovery process was dependent on concentration of DCI used: the cells pre-exposed to 17.5  $\mu\text{M}$  and 70  $\mu\text{M}$  DCI reached 60% and 25% of control phagocytic activity, respectively, in two hours. When digestive vacuoles forming capacity was analyzed, a non normal distribution may be found, with many cells showing no vacuole formation following DCI pretreatment (Fig. 3).

Their number is decreasing during recovery process proportionally to drug concentration. A slight modification observed in the vacuole distribution in control sample may be due to the fact that non-synchronous culture has been used since it was demonstrated that phagocytic activity is dependent on the cell cycle (Fujikawa-Yamamoto 1983).

Ultrastructural investigation was focused on the cytopharyngeal region of the cells (Pl. I, II). Discoidal vesicles have been detected in both DCI pretreated (Pl. I 1) and DCI treated cells (Pl. I 3). Aliquots of these ciliates derived from the samples showing 100% and 23% inhibition of digestive vacuoles formation, respectively.

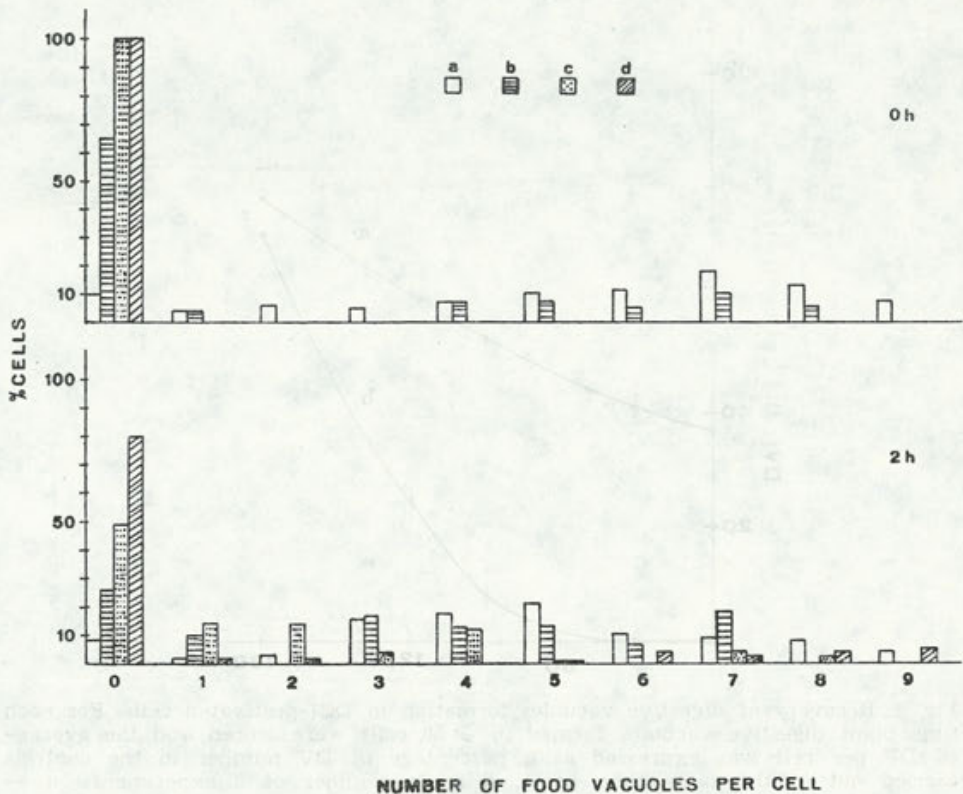

Fig. 3. Distribution of digestive vacuoles in DCI-pretreated cells and during recovery from inhibition. Result of one experiment expressed as percent of cells in the population of  $\geq 50$  examined (Ordinate). a — control, b — 17.5  $\mu\text{M}$  DCI, c — 35  $\mu\text{M}$  DCI, d — 70  $\mu\text{M}$  DCI

## Discussion

- Experiments and observations presented in this paper indicate that:
- (1) dichloroisoproterenol inhibition of *Paramecium* phagocytosis is dose dependent;
  - (2) it is not related to the cells age when long-term starved ciliates have been examined;
  - (3) cells may recover from inhibition in the time periods increasing with the increased DCI concentration;
  - (4) intracellular membrane pool indispensable for phagosome formation is still available in DCI-treated and pretreated cells.

The dose dependence of inhibiting action of DCI on phagocytosis has been shown in *Tetrahymena* (Ricketts 1983, Fok and Shock-



ley 1985). However, these data are contradictory. The complete cessation of vacuole formation reported by Ricketts (1983) occurred at 700  $\mu\text{M}$  DCI. In recent studies of Fok and Shockley (1985) it has been shown that when DCI and latex spheres have been added to cell simultaneously, DCI above 20  $\mu\text{M}$  inhibited vacuole formation in a dose dependent manner. When cells were pre-exposed to 40  $\mu\text{M}$  DCI for 10 min before being pulsed with latex beads, vacuole formation was completely blocked. Upon further exposure to drug cells could recover from this inhibition. Thus the data obtained by us are consistent with those of Fok and Shockley (1985) as regards the range of the lowest DCI concentrations inhibiting the vacuole formation (Fig. 1). On the other hand, Ricketts working with *Tetrahymena* pretreated with very high DCI concentration (300  $\mu\text{M}$ ) observed reversibility of inhibition following washing the cells. Process of recovery of phagocytic activity observed in this study as well as vacuoles distribution resemble the data reported previously when restoration of endocytosis abolished by supravital removal of external part of surface coat was studied (Wyroba and Brutkowska 1978). This may also suggest that the attachment phase of phagocytosis was blocked by DCI action.

It has been shown that long-term starved *Paramecium* cells may internalize ruthenium red when a simultaneous staining and fixation procedure has been applied (Wyroba 1984). Endosomes of different size up to 0.6  $\mu\text{m}$  in diameter filled with ruthenium red- $\text{OsO}_4$  reaction product were randomly localized in the cytoplasm. A detailed ultrastructural observation is leading to a suggestion that the detected endosomes may be derived from the discoidal vesicles (Wyroba — unpublished observation). Dichloroisoproterenol pretreatment abolished completely this endocytosis associated with cell surface staining and gave rise to the formation of small "empty" vesicles or vacuoles within the cytoplasm (Wyroba 1986). Their appearance suggested that membrane pool was existing in spite of DCI action. In fact, a pool of discoidal vesicles indispensable for phagosome formation has been detected both in DCI-treated and DCI-pretreated cells. This seems to indicate that the effect of beta-reception antagonist was limited to the cell membrane. It is tempting to speculate that *Paramecium* membrane may possess membrane  $\beta$ -receptors but further study on this problem is necessary. Besides, much attention has been recently focused on the process of endocytosis. This is mainly due to the fact that many molecules such as plasma proteins, hormones, toxins and viruses enter the cell by this pathway (Pastan and Willingham 1983). It seems that living ciliate not exhibiting any phagocytic activity may provide a useful model for cell biology studies by excluding the endocytic entering of the substances to the cell interior.

## ACKNOWLEDGMENTS

Author is grateful to Prof. A. T. Soldo (veterans Administration Hospital, Medical Center, Miami, U.S.A.) for sending the cultures of *Paramecium aurelia* 299 s.

## REFERENCES

- Allen R. D. 1974: Food vacuole membrane growth with microtubule associated membrane transport in *Paramecium*. *J. Cell Biol.*, 63, 904-922.
- Allen R. D. 1984: *Paramecium* phagosome membrane: from oral region to cytoproct and back again. *J. Protozool.*, 31, 1-6.
- Allen R. D. and Fok A. K. 1980: Membrane recycling and endocytosis in *Paramecium* confirmed by horse-radish peroxidase pulse-chase studies. *J. Cell Sci.*, 45, 131-145.
- Fok A. and Shockley B. U. 1985: Processing of digestive vacuoles in *Tetrahymena* and the effects of dichloroisoproterenol. *J. Protozool.*, 32, 6-9.
- Fujikawa-Yamamoto K. 1983: Cell cycle dependence of phagocytic activity in 3T3 cells. *Cell Struct. Funct.*, 8, 456.
- Giordano P., Wyroba E. and Bottiroli G. 1985: Internalization of cycloheptaamylose-dansyl chloride complex during labelling of surface membranes in living *Paramecium aurelia* cells. *Bas. Appl. Histochem.*, 29, 121-133.
- Kloetzel J. A. 1974: Feeding in ciliated Protozoa. I. Pharyngeal disks in *Euplotes*: a source of membrane for food vacuole formation. *J. Cell Sci.*, 15, 379-401.
- Moran N. C. and Perkins M. E. 1958: Adrenergic blockade of the mammalian heart by a dichloro analogue of isoproterenol. *J. Pharmacol. Exp. Ther.*, 124, 223-237.
- Pastan I. and Willingham M. C. 1983: Receptor-mediated endocytosis: coated pits, receptosomes and the Golgi. *Trends Biochem. Sci.*, 8, 250-254.
- Ricketts T. R. 1983: Dichloroisoproterenol and digestive vacuolar formation, movement and egestion in *Tetrahymena pyriformis* GL-9. *Protoplasma*, 115, 25-33.
- Soldo A. T., Godoy G. A. and van Wagtenonk W. J. 1966: Growth of particle-bearing and particle free *Paramecium aurelia* in axenic culture. *J. Protozool.*, 13, 492-497.
- Soldo A. T. and van Wagtenonk W. J. 1967: A method for the mass collection of axenically cultivated *Paramecium aurelia*. *J. Protozool.*, 14, 497-498.
- Wyroba E. 1984: Endocytosis of ruthenium red during staining of cell surface. In: *Electron Microscopy*. (eds. Csanady A., Röhlick P., Szabo D.) Petöfi Nyomada, Kecskemet, 3, 1851-1852.
- Wyroba E. 1986: Dichloroisoproterenol abolishes endocytosis associated with cell surface staining. *Folia Cytochem. Cytobiol.*, (in press).
- Wyroba E. and Brutkowska M. 1978: Restoration of phagocytic activity of *Paramecium tetraurelia* suppressed by previous digestion of surface coat. *Acta Protozool.*, 17, 515-524.

## EXPLANATION OF PLATES I-II

I-II: The cytopharyngeal region of *Paramecium* cell

1: Cell pretreated with 70  $\mu$ M DCI (50 000 $\times$ )

2: Control cell (50 000 $\times$ ). Discoidal vesicles (d) are attached to the ribbons of microtubules (m)

3: Ciliate treated with 70  $\mu$ M DCI (70 000 $\times$ )



## Stimulation of Phagocytosis by Diazepam in Several Subsequent Generations of the *Tetrahymena*

Rowaida S WYDAN, Zsuzsa DARVAS  
and György CSABA

Department of Biology, Semmelweis University of Medicine,  
1445 Budapest, Nagyvárad tér 4, Hungary

Received on 8 October 1985

*Synopsis.* Primary exposure to benzodiazepine (diazepam) did not influence the phagocytotic activity of the *Tetrahymena* cells directly exposed, but stimulated it in their progeny generations. Reexposure to diazepam did not further increase the phagocytotic activity of the unicellular. It appears that of the two phenomena — functional alteration and imprinting — following upon primary cellular interaction with molecules acting at receptor level, only the former takes place in the case of diazepam.

The cell membrane of the *Tetrahymena* contains receptors capable of binding hormones of higher vertebrates. These structures are either integral parts of the membrane, or arise therein under direct hormonal influence (Csaba 1980, 1981). The first interaction with a hormone alters a given function (e.g., the division) of the unicellular so durably that the functional change persists in many progeny generations. Moreover, hormonal imprinting, which occurs at the primary interaction between unicellular and hormone, accounts for an increased cellular response to the latter on reexposure (Csaba 1984). There is evidence that non-hormone molecules acting at receptor level are also able to evoke an increased response of the unicellular. Among others the plant hormone gibberelline, the structurally steroid-like molecule benzpyrene (Csaba et al. 1982), and the cardiac glycosides digoxin and ouabain (Csaba et al. 1983) have been shown to induce a hormone-like imprinting in the *Tetrahymena*. In view of this we speculated that, at the unicellular level, the information value of a drug molecule was neither greater nor lesser than that of a vertebrate hormone, whence the for-

mer could as well represent a signal molecule as the latter, if an adequate receptor had arisen for it during primary interaction. To substantiate this hypothesis, we investigated whether benzodiazepines were able to elicit a functional alteration and induce imprinting in the *Tetrahymena*.

### Materials and Methods

*Tetrahymena pyriformis* GL cells, maintained for two days in 0.1% yeast extract containing 1% Bacto trypton medium, were exposed to  $10^{-7}$  or  $10^{-9}$ M benzodiazepine (diazepam, Richter, Budapest), for 24 h at 28°C, were returned to plain medium for two days, and were finally placed for one day in Losina-Losinsky solution (starving) which represents a physiological solution for the *Tetrahymena*.

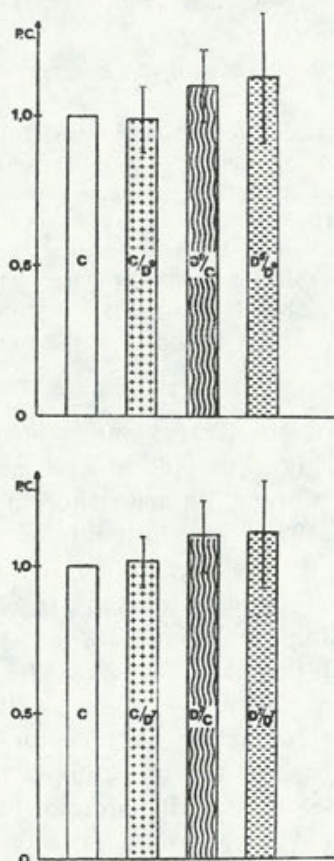

Fig. 1. Phagocyte coefficients (P.C.) of the *Tetrahymena* treated by diazepam once or twice. C — control, D<sup>7</sup> — diazepam  $10^{-7}$ , D<sup>9</sup> — diazepam  $10^{-9}$ M. X/X — first treatment/second treatment. Significances related to the control: C/D not significant, D<sup>7</sup>/C and D<sup>9</sup>/C —  $P < 0.02$ ; D<sup>7</sup>/D<sup>7</sup> and D<sup>9</sup>/D<sup>9</sup> —  $P < 0.1$ ; D<sup>9</sup>/C is significant ( $P < 0.05$ ) to C/D<sup>9</sup>



Subsequently the two pretreated mass cultures and a third mass culture which had not been pretreated, were divided into two subgroups, for the following treatments:

(1) Cells not preexposed, and fed Chinese ink simultaneously with diazepam treatment.

(2) Cells preexposed to diazepam for 24 h, but not reexposed to it during feeding Chinese ink.

(3) Cells preexposed to diazepam for 24 h and reexposed to it simultaneously with feeding Chinese ink.

Chinese ink was ground, suspended in Losina solution, filtered and fed for 5 or 15 min to cells starved for one day. Chinese ink phagocytosis was arrested by addition of 4% formaldehyde (in PBS). The cells were cautiously sedimented by manual centrifugation, the Chinese ink suspension was decanted, the cell sediment was resuspended in fresh Losina solution, spread on slides, and dried. The vacuoles were counted in 50 cells on each slide, and the mean value was regarded as the phagocytosis index (PI). The PI of the control group was related to the PI-s for the experimental groups to obtain the phagocytosis coefficient (PC), which is shown in the Fig. 1. Each experiment was repeated eight times, thus each column in the Figure represents the vacuole count of 400 cells. The inter-group differences were evaluated for significance by Student's t-test.

## Results and Discussion

The diazepam concentrations  $10^{-7}$ - $10^{-9}$ M represent physiological levels of active substance in higher organisms, and — as demonstrated earlier — for the *Tetrahymena* as well. In the present study, neither  $10^{-9}$  nor  $10^{-7}$ M diazepam increased in itself the phagocytotic activity of the *Tetrahymena* on primary exposure. However, the progeny generations of the directly exposed cells showed a considerable increase in phagocytotic activity without reexposure to diazepam. Although the preexposed cells presumably failed to divide in the physiological salt solution for the lack of nutrients, they had certainly given rise to about 10 new generations during a two-day return to the plain nutrient medium. It follows that the functional influence of diazepam came into display in a distant progeny generation.

Diazepam did not, however, give rise to imprinting. The PC of the 5 min reexposed cells did not increase over the PC assessed in the progeny arisen after preexposure. Thus functional change and imprinting are not necessarily parallel phenomena; it appears that certain active substances induce either the former or the latter, but never both.

Benzodiazepine is no specific activator of phagocytosis. Increase in the phagocytic activity of the benzodiazepin-treated cells merely portrayed a behavioral change under the influence of the drug. The univer-

salinity of the change is indicated by our earlier experimental observation (Darvas et al. 1985) that diazepam had durably altered the mitotic rate of the *Tetrahymena* without giving rise to imprinting. However, it should be noted that, unlike phagocytosis, the mitotic rate was immediately altered — increased by about 40% — by primary exposure to diazepam. Thus the impact of diazepam on cell behaviour apparently varies with the type of function.

While primary exposure to  $10^{-7}$ M diazepam always increased the PI significantly over the control,  $10^{-9}$ M caused only a near to significant increase. In this light  $10^{-7}$ M may have represented the optimum concentration in the given experimental system. It is also remarkable that the inter-group difference was not significant in any relation after 15-min feeding of Chinese ink; this may have been consequent upon saturation of the capacity for Chinese ink intake within that period.

Finally, it should be taken into consideration that in combination with Chinese ink feeding, reexposure to diazepam lasted only 5 or 15 min, whereas preexposure always lasted 24 h, during which the change of the function studied — the stimulation of phagocytotic activity — may well have taken place.

#### REFERENCES

- Csaba G. 1980: Phylogeny and ontogeny of hormone receptors. The selection theory of receptor formation and hormonal imprinting. *Biol. Rev.*, 55, 47-63.
- Csaba G. 1981: Ontogeny and phylogeny of hormone receptors. Karger, Basel-New York.
- Csaba G. 1984: The present state in the phylogeny and ontogeny of hormone receptors. *Horm. Metab. Res.*, 16, 329-335.
- Csaba G. 1985: The unicellular *Tetrahymena* as model cell for receptor research. *Int. Rev. Cytol.* 95, 327-377.
- Csaba G., Németh G. and Vargha P. 1982: "Memory" of first interaction with physiological or biologically active foreign molecules (benzopyrene, gibberelline) in a unicellular (*Tetrahymena*) model system. *Z. Naturforsch.*, 37C, 1042-1044.
- Csaba G., Inczefi-Gonda Á., Dobozy O., Varró A. and Rablóczyk G. 1983: Impact of neonatal treatment with cardioactive glycosides (digoxin, ouabain) on receptor binding capacity, blood level and cardiac function in the adult rat. Extension of the imprinting theory. *Gen. Pharmacol.*, 14, 709-715.
- Darvas Zs., Swydan R. and Csaba G. 1985: Influence of benzoiazepine (diazepam) on the growth of the *Tetrahymena* on single and repeated treatment. *Biomed. Biochem. Acta.* 44, 1725-1728.



## Chemoaccumulations of the Colorless Flagellate, *Astasia longa*, in the Presence of the Photosensitizer Methylene Blue

Ewa MIKOŁAJCZYK<sup>1</sup>, Wilhelm NULTSCH  
and Donat-P. HÄDER

Fachbereich Biologie der Philipps-Universität Marburg,  
Karl v. Frisch-Str., D-3550 Marburg 1, Federal Republic of Germany

Received on 3 September 1985

*Synopsis.* Accumulations of *Astasia longa* in light fields have been observed in the presence of the photosensitizer, methylene blue ( $10^{-4}M$ ) in culture medium. The cells show only slight light responses in the control experiments. *Astasia longa* also accumulates around the tip of a capillary filled with methylene blue when irradiated with bright white light ( $750 Wm^{-2}$ ). Track analysis shows that the cells do not move toward the source chemotactically in a directed fashion but rather undergo step-down chemophobic responses when they experience a decrease in the chemotactic concentration below a certain threshold. Thus, a histogram of the movement in the neighborhood of the capillary tip does not show a strictly directed movement but rather a bias towards the capillary.

Many photodynamic effects have been reported to damage or kill organisms (Ito 1977, Spikes 1982). In some microorganisms, however, the application of protodynamic dyes causes light-induced motor responses (Metzner 1920, 1921, 1924, Harayama and Iino 1977). The colorless flagellate, *Polytomella magna*, has been demonstrated to avoid light fields in the presence of the photosensitizers riboflavin and methylene blue, while it does not show any response to light in the absence of photosensitizers (Nultsch and Häder 1984, 1985). Similar responses were found in high irradiances in *Peridiniopsis berolinensis* (Häder 1984).

In both cases it could be demonstrated with capillary test tube experiments that the photosensitizer is not bound to the cell and does not

<sup>1</sup> Permanent address: Nencki Institute of Experimental Biology, Department of Cell Biology, 3 Pasteur Str., 02-093 Warsaw, Poland

operate as a substitute for a missing natural photoreceptor. Thus, the cells do not undergo an induced phototactic orientation as suggested by Metzner (1921) but rather respond chemotactically to a photoproduct formed by light in the presence of the photosensitizer.

Photodynamic effects are usually mediated by the photosensitizer in the triplet excited state. In the presence of oxygen both possible subsequent pathways (radical formation, type I reactions and singlet oxygen formation, type II reactions) can produce  $H_2O_2$  as a photoproduct (Foote 1976, Spikes and Straight 1981, Ito 1983). In order to discriminate between the two reaction types quenchers of triplet states ( $NaN_3$  and KI), the superoxide anion (p-benzoquinone, for type I) and singlet oxygen, crocetin, for type II) can be applied. Using these quenchers it could be shown that the response in *Polytomella* is mediated by a type I reaction (Nultsch and Kumar 1984, Kumar and Nultsch 1985). The reaction type in *Peridiniopsis* has not been revealed yet (Häder 1984).

Recently, another colorless flagellate, *Astasia longa*, has been also shown to respond to light in the presence of riboflavin (Mikołajczyk et al. 1985). This organism, unlike the closely related green *Euglena gracilis*, does not show phototactic orientation (Pringsheim 1942, 1948, Pringsheim and Hovasse 1948, Gössel 1957) but it shows photophobic responses upon a step-up influence rate (Suzuki and Williamson 1983, Mikołajczyk and Kuźnicki 1984, Mikołajczyk 1984). The cells accumulate in light fields of high fluence rates in the presence of riboflavin. Since  $NaN_3$  and KI as well as 1,4-benzoquinone strongly inhibit this response, while crocetin does not, it was concluded that the response is mediated by a type I reaction leading to the formation of  $H_2O_2$ . This hypothesis was further supported by the finding that *Astasia longa* accumulates around the opening of a capillary filled with either riboflavin (under high intensity irradiation) or  $H_2O_2$ . Visual observations of the paths indicated that the cells did not show a directed chemotactic orientation but rather accumulated by means of chemophobic response.

The present paper describes the responses of *Astasia longa* in the presence of the photosensitizer methylene blue.

## Material and Methods

All experiments were carried out with the colorless flagellate, *Astasia longa* (*Euglenophyta*) strain 1204/17D Pringsheim. The cells grew in static cultures in Bloomington medium at pH 6.9 (Starr 1964). Aliquots of about 1 ml cell suspension from an exponentially growing culture were inoculated in 80 ml contained



in a 100 ml Erlenmeyer flask and kept in darkness at 23°C. For the experiments 4 day old cultures in the exponential phase were used when the concentration had reached a density of about  $4.7 \times 10^5$  cells/ml and the pH had reached a value of about 8.0-8.3.

Methylene blue (Sigma, S. Louis MO) was dissolved in culture medium buffered with  $5 \times 10^{-2}$ M Tris-HCl at pH 8.5. For the experiments the stock solution of  $10^{-2}$ M methylene blue was diluted with culture suspension to produce a final concentration of  $10^{-4}$ M. For the controls, appropriate amounts of buffered culture medium (without methylene blue) were added to the cell suspension.

The response of *Astasia longa* in light fields was observed in a microvideo system described in detail by Nultsch and Häder (1984) starting about 2 min after preparation. A white light field (0.8 mm in diameter) with a fluence rate of about  $750 \text{ Wm}^{-2}$  was focussed into the cell suspension mounted on a microscope slide sealed with vaseline (Mikołajczyk et al. 1985). The light field was produced with a 250 W Prado slide projector (Leitz, Wetzlar) equipped with 24 V a quartz iodine lamp. The cells were observed using an infrared sensitive b/w video camera mounted on top of an inverted light microscope (Zeiss, IM 35). The number of cells in the light field were counted during playback in individual video frames at intervals of 10 s after the start of the irradiation.

For the capillary experiments methylene blue was dissolved in culture medium buffered to a pH of 8.5 with  $5 \times 10^{-2}$  Tris-HCl and diluted to the final concentration of  $10^{-4}$ M with culture supernatant. The photosensitizer was sucked into a capillary pipette (diameter about 200-300  $\mu\text{m}$ , length about 80 mm) and the rear end was sealed with vaseline. The tip of this capillary was inserted in a cell suspension mounted previously on a microscope slide under a coverslip and sealed with vaseline. The reactions of the cells were observed under infrared irradiation ( $> 780 \text{ nm}$ ) when the methylene blue preparation in the capillary was irradiated with white light ( $750 \text{ Wm}^{-2}$ ).

The movement of *Astasia longa* in the neighborhood of the capillary tip was followed using a fully automatic, computer-aided microvideo system as described previously (Häder and Lebert 1985).

## Results

### White Light Field Experiments

*Astasia longa* accumulated in white light fields in the presence of  $10^{-4}$ M methylene blue. At the beginning of irradiation only a few cells were in the light field (Pl. I 1 a). After 90 s about 7 times as many cells had accumulated (Pl. I 1 b). This accumulation was even more obvious when at that time the iris was opened (Pl. I 1 c). The time kinetics of this response is shown in Fig. 1 after about 90 s the accumulation in the light field reached a saturation. Several minutes later the cells started to leave the field and the initial value was approached about 4 min after the onset of the experiment.

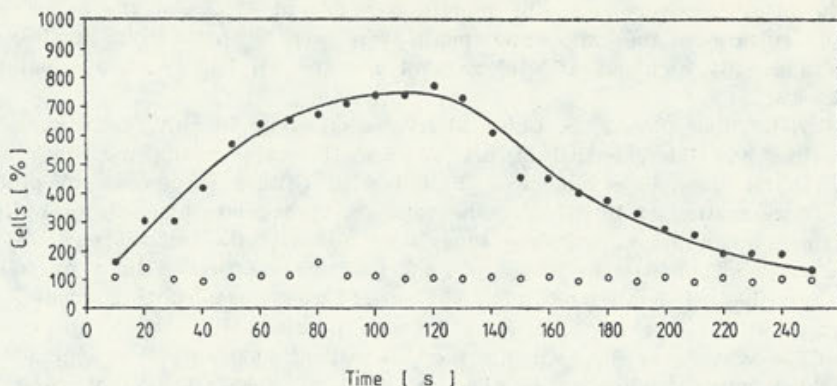

Fig. 1. Accumulation and subsequent dispersal of *Astasia* in a light field ( $750 \text{ Wm}^{-2}$ ) in the presence of methylene blue ( $10^{-4}\text{M}$ ). *Abcissa*: time in s; *ordinate*: number of cells in the light field (0.8 mm in diameter) as a percentage of the initial number of cells at the beginning of the irradiation. Open circles untreated control, closed circles methylene blue

### Capillary Test Tube Experiments

When a capillary tube filled with methylene blue ( $10^{-4}\text{M}$ ) was inserted into a suspension of *Astasia longa* and irradiated vertically with white light the cells started to accumulate around the capillary tip. After about 1-2 min there is a distinctive accumulation (Pl. I 2 a, b). Accumulations could neither be observed in darkness or far red light.

### Directionality of Movement

In order to clarify the mechanism of response the swimming paths in the neighborhood of the capillary tip were traced on an acetate overlay over the video monitor. The cells did not move in a directed fashion toward the source of the chemoattractant. They rather responded chemophobically (Fig. 2). Cells which approached the capillary did not show any behavioral response. When they moved past the capillary and down the gradient of the chemoattractant they experienced a phobic response. Sometimes more than one response was observed in sequence.

The directionality of the orientation in the neighborhood of the capillary tip was quantified using a computerized fully automatic video-system. The microcomputer requested the digitization of an image, located the position of an organism and followed it for a predefined period of time. The angle of deviation from the direction of the chemoattractant source ( $0^\circ$ ) was recorded in a disk file. After 1000 angles had been acquired a histogram of the distribution was calculated using 64 bins  $5.6^\circ$



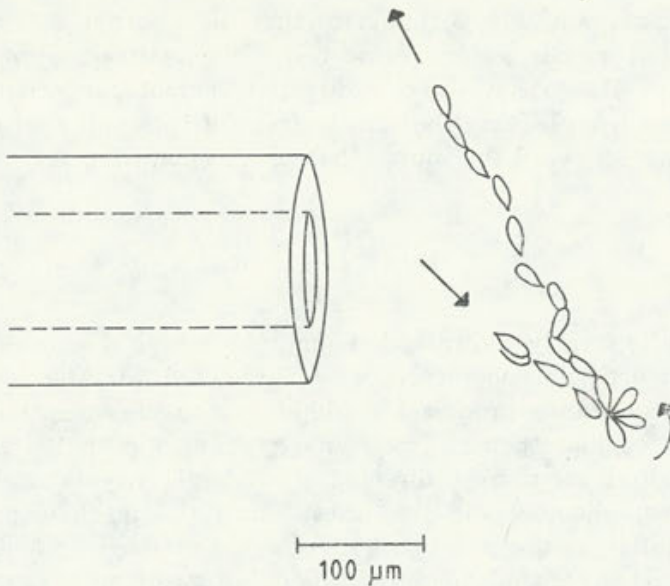

Fig. 2. Pattern of chemophobic response of *Astasia* when swimming down a gradient of the photoproduct formed by methylene blue irradiation diffusing out of a capillary in light. The positions were drawn every 100 ms

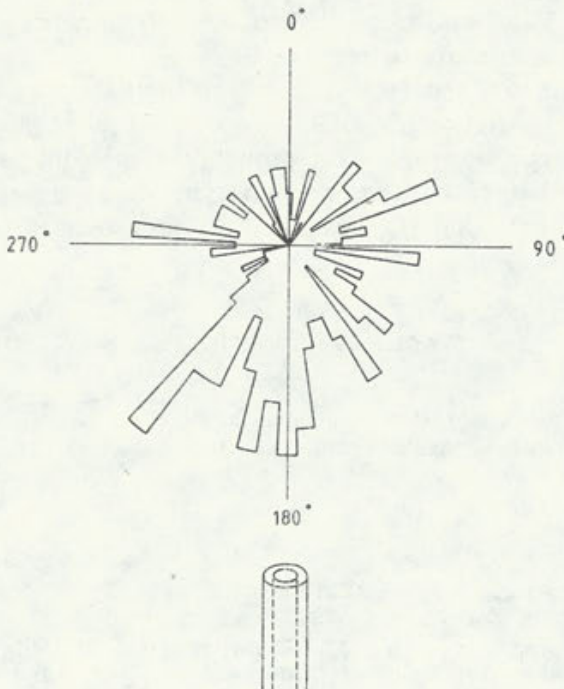

Fig. 3. Histogram of *Astasia* moving in front of a capillary tube filled with methylene blue. The angles of deviation of the cells from the direction of the capillary ( $180^\circ$ ) was binned in 64 sectors. Number of organisms 1000

wide. The histogram (Fig. 3) indicates that there is not a very directed movement but rather a bias toward the chemoattractant source. Obviously, the cells do not show a directed chemotactic orientation but are prevented from leaving the area in front of the capillary. Thus, more organisms move toward the source than away from it.

### Discussion

The results clearly indicate that methylene blue does not operate as an intrinsic artificial photoreceptor for the cell. *Astasia longa* rather reacts to a substance produced by light in the presence of methylene blue with a chemoresponse. Track analysis indicates that accumulations are not brought about by a directed chemotactic orientation but rather by step-down chemophobic responses. Thus, the mechanism of orientation is similar as the one to riboflavin (Mikołajczyk et al. 1985).

*Astasia longa* responds also to gradients of gases, such as CO<sub>2</sub> and O<sub>2</sub>, dissolved in the medium (Borgers and Kitching 1956). Therefore, it is important to make sure in the experiments that there are no unwanted gas gradients between the capillary content and the surrounding cell suspension. This was accomplished by bubbling the solutions with an appropriate gas mixture before use.

It has been shown that the response of *Astasia longa* to riboflavin follows a type I reaction (Mikołajczyk et al. 1985), i.e., radical one. The same type of reaction is probably responsible in the case of methylene blue but this question cannot be decided yet. It has been demonstrated though, that H<sub>2</sub>O<sub>2</sub> causes a chemoresponse in *Astasia longa*.

### ACKNOWLEDGEMENTS

This work has been supported by a financial aid from the Deutsche Forschungsgemeinschaft. The authors thank H. Maus and S. Völk for skillful technical assistance.

### REFERENCES

- Borgers J. A. and Kitching J. A. 1956: Reaction of the flagellate *Astasia longa* in gradients of dissolved carbon dioxide. Proc. Roy. Soc. London, 144, 506-519.
- Foote C. S. 1976: Photosensitized oxidation and singlet oxygen: consequences in biological systems. In: Free Radicals in Biology, Vol. 2, (ed. W. A. Pryor), Academic Press, New York, p. 85-133.



- Gössel I. 1957: Über das Aktionsspektrum der Phototaxis chlorophyllfreier Euglenen und über die Absorption des Augenflecks. Arch. Mikrobiol., 27, 288-305.
- Häder D.-P. and Lebert M. 1985: Computer analysis of motile microorganisms. Photochem. Photobiol., 42, 509-514.
- Häder M. 1984: Light-induced chemotactic reactions in the dinoflagellate, *Peridiniopsis berolinensis*. Photochem. Photobiol., 40, 533-537.
- Harayama S. and Jino T. 1977: Ferric ion as photoreceptor of photophobic taxis in non-pigmented *Rhodospirillum rubrum*. Photochem. Photobiol., 25, 571-578.
- Ito T. 1977: Cellular and subcellular mechanism of photodynamic action: the  $^1O_2$  hypothesis as a driving force in recent research. Photochem. Photobiol., 28, 493-508.
- Ito T. 1983: Photodynamic agents as tools for cell biology. In: Photochemical and Photobiological Reviews. Vol. 7, (ed. K. C. Smith), Plenum Press, New York, p. 141-186.
- Kumar H. D. and Nultsch W. 1985: Effects of saffron extract and carotenoid preparations on the photodynamically induced chemotactic response of *Polytomella magna*. Photobiochim. Photobiophys., 9, 39-42.
- Metzner P. 1920: Über die Wirkung photodynamischer Stoffe auf *Spirillum volutans* und die Beziehungen der photodynamischen Erscheinung zur Phototaxis. I. Mitteilung. Biochem. Z., 101, 33-53.
- Metzner P. 1921: Zur Kenntnis der photodynamischen Erscheinung. II. Mitteilung: Die induzierte Phototaxis bei *Paramecium caudatum*. Biochem. Z., 113, 145-175.
- Metzner P. 1924: Zur Kenntnis der photodynamischen Erscheinung. III. Mitteilung: Über die Bindung der wirksamen Farbstoffe in der Zelle. Biochem. Z., 148, 498-523.
- Mikołajczyk E. 1984: Photophobic responses in *Euglenina*: II. Sensitivity to light of the colorless flagellate *Astasia longa* in low and high viscosity medium. Acta Protozool., 23, 85-92.
- Mikołajczyk E. and Kuźnicki L. 1984: Speculation on the origin of two photoreaction systems in *Euglena*. Progress in Cell Biology, 11, 411-413.
- Mikołajczyk E., Häder D.-P. and Nultsch W. 1985: Photodynamically induced chemoresponses of the colorless flagellate, *Astasia longa*. Arch. Microbiol. (submitted).
- Nultsch W. and Häder M. 1984: Light-induced chemotactic responses of the colorless flagellate, *Polytomella magna*, in the presence of photodynamic dyes. Arch. Microbiol., 139, 21-27.
- Nultsch W. and Häder M. 1985: Photodynamically induced behavioural responses of the colourless flagellate *Polytomella magna*: effects of methylene blue. Proc. Indian Acad. Sci. (Plant Sci.), 94, 475-485.
- Nultsch W. and Kumar H. D. 1984: Effects of quenching agents on the photodynamically-induced chemotactic response of the colorless flagellate *Polytomella magna*. Photochem. Photobiol., 40, 539-543.
- Pringsheim E. G. 1942: Contribution to our knowledge of saprophytic algae and flagellata. III. *Astasia*, *Distigma*, *Menoidium* and *Rhabdomonas*. New Phytol., 41, 171-205.
- Pringsheim E. G. 1948: Taxonomic problem in the *Euglenineae*. Biol. Rev., 23, 46-61.
- Pringsheim E. G. and Hovasse R. 1948: The loss of chromatophores in *Euglena gracilis*. New Phytol., 47, 52-87.
- Spikes J. D. 1982: Photodynamic reactions in photomedicine. In: The Science of Photomedicine, (ed. J. D. Regan and J. A. Parrish), Plenum Press, New York, 113-144.
- Spikes J. D. and Straight R. 1981: The sensitized photooxidation of biomolecules, an overview: In: Oxygen and Oxyradicals in Chemistry and Biology, (ed. M. A. J. Rodgers and E. L. Powers), Academic Press New York, p. 421-424.
- Starr R. C. 1964: The culture collection of algae at Indiana University Am. J. Bot., 51, 1013-1044.
- Suzaki T. and Williamson R. E. 1983: Photoresponse of a colorless euglenoid flagellate, *Astasia longa*. Plant Science Lett., 32, 101-107.

#### EXPLANATION OF PLATE I

1: Accumulations of *Astasia* in a light field in the presence of methylene blue. a — At the beginning of the irradiation, b — After 90 s in light, c — When the diaphragm is opened (after 90 s). Bar 0.2 mm

2: Accumulation of *Astasia* around the tip of a capillary tube filled with methylene blue. a — At the beginning of the irradiation, b — After 120 s in light. Bar 0.2 mm



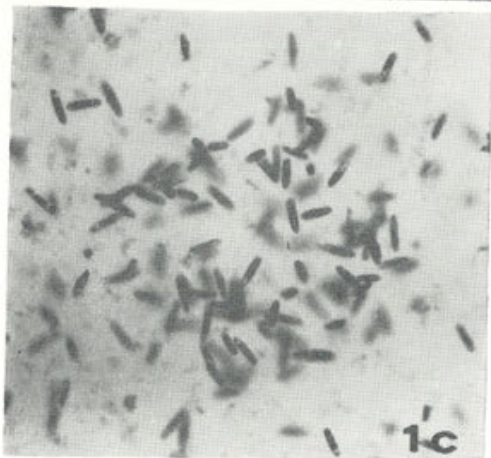
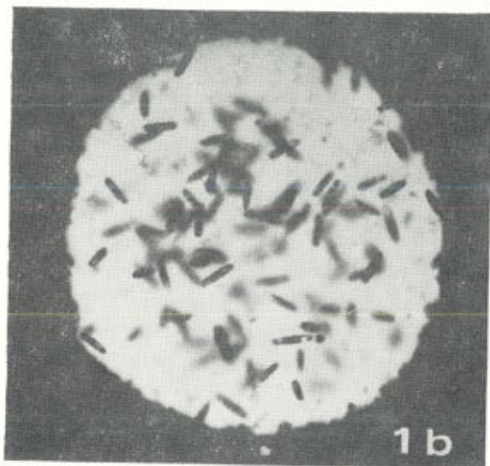
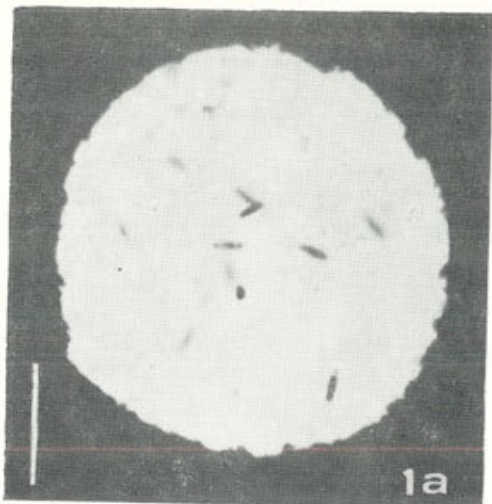

E. Mikołajczyk et al.

auctores phot.





## Graded Morphogenetic Response to Preparing Cell-Cell Interactions in *Euplotes vannus*

Wolfgang LUEKEN and Barbara OELGEMÖLLER

Department of Zoophysiology, University of Osnabrück,  
D-4500 Osnabrück, Federal Republic of Germany

Received on 18 September 1985

*Synopsis.* Imbalanced mixtures (1:100, 1:50) of two mating types (mts) of *Euplotes vannus* were used to find out whether early conjugation promoting cell interactions (stimulation) between colliding cells are graded or of the all-or-nothing type. Stimulation effects were quantified by measuring the extensions of Con A binding site fields (OFs) on the cell surfaces. Doublets were used for discrimination between rare and abundant cells. Specimens with a low chance to collide with members of the opposite mt develop smaller OFs than cells with frequent heterotypic contacts. The result is discussed according to step-wise mutual cell-cell interactions and to asymmetrical collisions.

In ciliates stimulation to conjugation is started when starved clones with different mating types are mixed. Usually after a waiting period of 45-60 min as first consequences a typical courtship behaviour and/or cell agglutination are observed (cp. Miyake 1981). In *Euplotes vannus*, the development of typical fields of Con A binding sites (OFs) in the pairing region of the cells (Lueken et al. 1981) has been found to precede by far all visible reactions (Lueken and Oelgemöller 1985). Since the OFs represent the very first effects of cell-cell interactions, it has been investigated if they can reflect quantitative differences in the stimulation state between cells. Graduation of stimulation was achieved by mixing clones in highly imbalanced ratios. To discriminate cells of different mating types doublet cells were used.

### Material and Methods

Strains belonging to the sibling species complex *Euplotes vannus/crassus* (Machelon et al. 1984) were originally collected at Naples/Italy. Singlet clones were B24 (mating type B) and D35 (mt D), the doublet clone 99b4 (mt B). Techniques

for cultivation and for breeding of desired clones have been reported elsewhere (Lueken et al. 1981, 1983).

Cells were concentrated to densities of 15-20 000 cells/ml by sieving (nominal aperture size 5  $\mu\text{m}$ ). They were mixed after 24 h of recovery in the appropriate proportions in staining blocks with 1.5 ml total volume. Every series of mixtures was started simultaneously. Samples were prepared for Con A binding sites when first pairs appeared. All experiments were performed in a constant temperature room at 24.5°C.

For visualization of Con A binding site fields (OFs) a newly developed method with horseradish peroxidase (HRP) was used; for details see Lueken and Oelgemöller (1985).

Total extinction of labeled OFs was determined by means of a Leitz MPV 1 microspectrophotometer with the two-wavelength method at 550 and 660 nm, respectively (Garcia 1962). Lengths of fields were measured on photographic negatives using a dissecting microscope.

## Results

In Plate I representatives of labeled cells from 1:1- and 1:100-mixtures are shown, with obvious differences in their OFs. Cytophotometric measurements of total extinctions at 550 nm from both samples are given as histograms in Fig. 1 a, b. Cells from the 1:1-mixture reveal a rather heterogenous distribution. This has been found to be due to variation in labeling density of the binding site fields. Nevertheless, it is clearly to be seen that in the 1:100-mixture the majority of the cells has developed OFs with smaller total extinctions as compared to cells

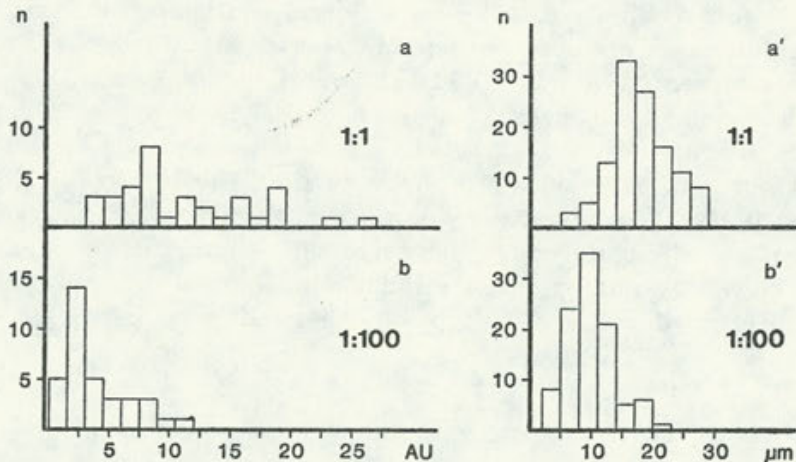

Fig. 1. Distribution of sizes of Con A binding site fields from 1:1 vs. 1:100 mixtures, a, b — measured as total extinctions (AU — arbitrary units), a', b' — measured as lengths of longitudinal axes



from the 1:1 ratio. The same kind of results is obtained (Fig. 1 a', b'), if, for the same samples, the lengths of the longitudinal axes of the OFs are taken as a measure for their binding site fields. Therefore the cytophotometric method has been replaced by the far less expensive lengths measurement. In three more experiments with the same procedure (results not shown) always the same effect was observed: cells taken from 1:1-mixtures develop more extended OFs than cells from the heavily imbalanced mixtures.

In the samples with a smaller average of OF sizes some cells reveal a normally extended binding site field. It is reasonable to suppose that these cells are members of the mating type that is in the minority. They should of course have enough opportunity to collide with partners of the frequent mating type and should therefore develop OFs with normal

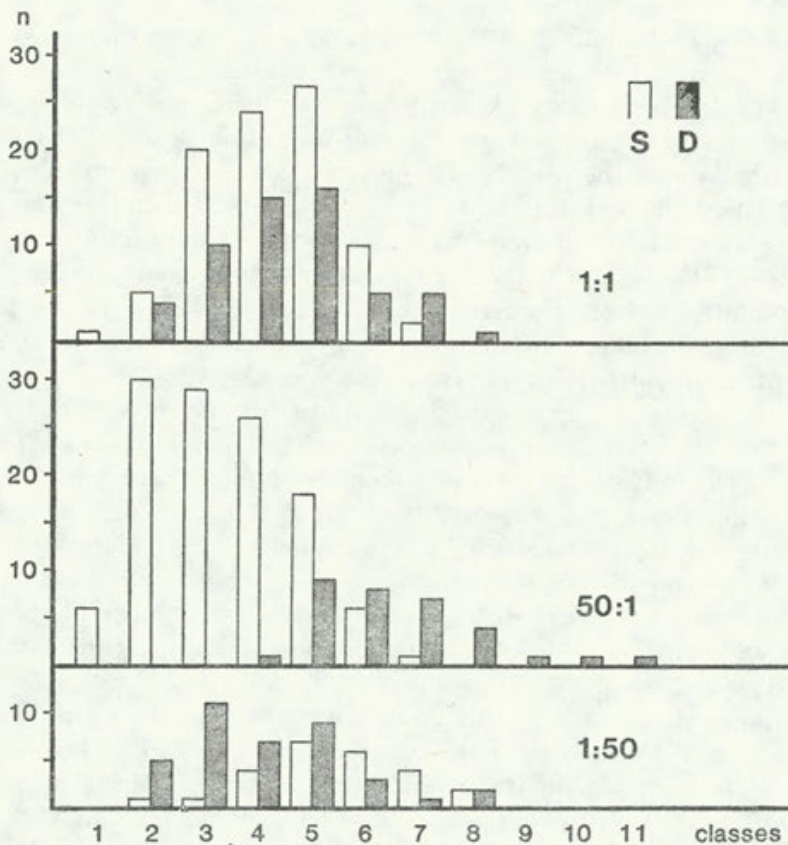

Fig. 2. Distribution of lengths of Con A binding site fields in three mixtures with different proportions (S:D) of mating types, S — singlet cells, D — doublet cells. The classes in the abscissa represent: 1 — 2-5, 2 — 5-8, etc., 11 — 32-35  $\mu\text{m}$

size as cells from a 1:1 mixture. Testing this assumption depends on the possibility to discriminate both cell types. This has been achieved by using mixtures with doublets and singlets of opposing mating type. One experiment of this kind is represented in Fig. 2. The proportion of doublets had to be enlarged to 1:50 instead of 1:100 since doublets have a strong tendency rather to swim than to creep on the bottom of the vessel and therefore are less engaged in conjugation. In the 1:1-mixture, singlets and doublets have nearly identical distributions of the sizes of their OFs. In the imbalanced mixtures, cells belonging to the frequent mating type express, in the average, smaller fields than their rarer partners and than cells in the 1:1-mixture.

### Discussion

Cells collide casually soon after mixing. In a highly imbalanced mixture, the frequent cells will rarely meet members of the rare mating type, whereas these nearly exclusively encounter foreign cells. If already the first heterotypic contact would lead, by mutual interactions, to complete stimulation, then each cell engaged should develop the Con A binding site field in the definite extension characteristic for the end of the prepairing stage (Lueken et al. 1981, Lueken and Oelgemöller 1985). The results of the measurements, however, clearly demonstrate quantization of stimulation: cells with fewer possibilities to meet cells with the opposite mating type develop less extended OFs than cells with frequent heterotypic contacts.

An interpretation on the basis of mutuality in interactions is, that cells stimulate each other in definite steps, which are equal for both partners. The differences between members of the rare and the abundant mating types, respectively, then are a function of cell numbers: cells with frequent heterotypic contacts quickly accumulate enough impulses to develop the final OF, whereas the corresponding impulses for the other mating type are distributed over a great number of specimens, each of which can only develop a less extended OF during the same space of time.

Another interpretation bases on an asymmetry in the collision events: as an active cell ordinarily moves in forward direction, it touches other cells predominantly with its anterior tip. Therefore effects of cell contacts will be concentrated there. That is the same region, where morphogenetic responses to stimulation are restricted to (Lueken et al. 1981, Suganuma et al. 1984). A causal relationship is suggestive. On



the other hand, the partners of the encounters have the contact areas distributed all over their bodies, in the anterior as well as in the posterior region. A localized expression of the widespread additive stimulation steps with restriction to the OF area would be in accordance with well-known capping phenomena. It becomes, however, unlikely by the occurrence of one side-labeled doublet cells (Lueken and Oelgemöller 1985).

Topographically different effects of collisions parallel in a striking manner important features of mechanostimulus-reception: In the related *Stylonychia mytilus* several kinds of ion channels (for  $K^+$  and for  $Ca^{2+}$ ) are unequally distributed over the cell body, with most remarkable differences between the anterior and the posterior parts (Deitmer 1984, Deitmer et al. 1984). Recently, Con A has been found to inhibit a special type of  $Ca^{2+}$  channels (Ivens and Deitmer 1985). But at present, correlations between these electrophysiological data and conjugation have not yet been demonstrated. Besides, chemoreception which might affect other electrophysiological events, especially the surface potential, must be taken into account (Tanabe et al. 1984), since stimulation to conjugation does not occur within a clone, but requires interactions between mating type different cells.

Graded stimulation within imbalanced mixtures is plausible for species where in the prepairing interaction direct contacts between cells are necessary, as in the *Euplotes vannus/crassus*<sup>1</sup> group (Heckmann and Siegel 1964, Luporini et al. 1979, own observations), *Oxytricha bifaria* (Ricci et al. 1980), *Tetrahymena thermophila* (Love and Rotheim 1984). In the latter species, Suganuma et al. (1984) have demonstrated evidence for graded stimulation in imbalanced mixtures. An interesting question is what consequences mt-imbalance may have when conjugation is induced by gamones that are excreted into the medium, as in *Euplotes raicovi* (Miceli et al. 1983, Raffioni et al. 1985), *E. octocarinatus* (Weischer et al. 1985); *E. patella* (Akada 1985), *Blepharisma* species (Miyake 1984). Different concentrations of gamones could lead to differences in the stimulation state, or the rarer cells could be induced to more intensive production of their gamones, as might be expected from the self-feeding mechanism found in *Blepharisma* (l.c.).

---

<sup>1</sup> Recently, in *E. crassus* a small amount of mating pheromone has been found in the medium (Luporini, personal communication), the function of which for the induction of conjugation is not yet known.

## ACKNOWLEDGEMENTS

The authors thank Dr. Breer and Dipl.-Biol. T. Krüppel for valuable suggestions, Mr. M. Gaertner for skillful technical assistance, and Mrs. Gitta Moehrke for preparing the manuscript. The work was supported by grant I/37492 from Stiftung Volkswagenwerk and by SFB 171-84.

## REFERENCES

- Akada R. 1985: Role of soluble factors (gamones) and calcium ions in conjugation of the ciliate *Euplotes patella* syngen 2. *J. Exp. Zool.*, 233, 169-173.
- Deitmer J. W. 1984: Evidence for two voltage-dependent calcium currents in the membrane of the ciliate *Stylonychia*. *J. Physiol.*, 355, 137-159.
- Deitmer J. W., Macheiner H. and Martinac B. 1984: Motor control in three types of ciliary organelles in the ciliate *Stylonychia*. *J. Comp. Physiol.*, 154, 113-120.
- Garcia A. M. 1962: Studies of DNA in leucocytes and related cells of mammals. II. On the Feulgen reaction and two-wavelength microspectrophotometry. *Histochemie*, 3, 178-194.
- Heckmann K. and Siegel R. W. 1964: Evidence for the induction of mating-type substances by cell to cell contacts. *Exp. Cell Res.*, 36, 688-691.
- Ivens I. and Deitmer J. W. 1985: Inhibition of a voltage-dependent Ca current by concanavalin A. *Pfluegers Arch.* (in press).
- Love B. and Rotheim M. B. 1984: Cell surface interactions in conjugation: *Tetrahymena* ciliary membrane vesicles. *Mol. Cell. Biol.*, 4, 681-687.
- Lueken W. W., Breer H. and Hartkemeyer M. 1981: Local and temporal pattern of Con A-binding site aggregation during conjugation in *Euplotes vannus* (*Ciliophora*, *Hypotrichida*). *J. Protozool.*, 28, 414-417.
- Lueken W., Gaertner M. and Breer H. 1983: Mating-type-specific loss of conjugation competence by irritation in *Euplotes vannus*. *J. Exp. Zool.*, 226, 11-17.
- Lueken W. and Oelgemöller B. 1985: Significance of Con A binding sites in conjugation of *Euplotes vannus*. *J. Exp. Zool.*, 236, 193-198.
- Luporini P., Bracchi P. and Esposito F. 1979: Specific contact-dependent cell-to-cell communication during preconjugal interaction of the ciliate *Euplotes crassus*. *J. Cell Sci.*, 39, 201-213.
- Machelon V., Générmont J. and Dattée Y. 1984: A biometrical analysis of morphological variation within a section of genus *Euplotes* (*Ciliata*, *Hypotrichida*), with special reference to the *E. vannus* complex of sibling species. *Orig. Life*, 13, 249-267.
- Miceli C., Concetti A. and Luporini P. 1983: Isolation of the mating-inducing factor of the ciliate *Euplotes*. *Exp. Cell Res.*, 149, 593-598.
- Miyake A. 1981: Physiology and biochemistry of conjugation in ciliates. In: *Biochemistry and Physiology of the Protozoa*, 2nd ed., vol. 4 (eds. M. Levandovsky and S. H. Hutner), Academic Press, Inc., New York, p. 125-198.
- Miyake A. 1984: Blepharismone: a conjugation-inducing tryptophan derivative in the ciliate *Blepharisma*. In: *Progress in Tryptophan and Serotonin Research*. (eds. H. G. Schlossberger, W. Kochen, B. Linzen and H. Steinhart), Walter de Gruyter and Co., Berlin, New York, p. 807-813.
- Raffioni S., Pignini E., Miceli C., Luporini P. and Concetti A. 1985: Isolation, identification, and characterization of the mating pheromones of *Euplotes raikovi*. *Abstr. VII Intern. Congr. Protozool.*, Nairobi, Kenya, 146.
- Ricci N., Cetera R. and Banchetti R. 1980: Cell to cell contacts mediating mating-type dependent recognition(s) during the preconjugal cell interactions of *Oxytricha bifaria* (*Ciliata*, *Hypotrichida*). *J. Exp. Zool.*, 211, 171-183.



- Suganuma Y., Shimode C. and Yamamoto H. 1984: Conjugation in *Tetrahymena*: formation of a special junction area for conjugation during the co-stimulation period. *J. Electron Microsc.*, 33, 10-18.
- Tanabe H., Kamo N. and Kobatake Y. 1984: Fluorometric estimation of surface potential change associated with chemotactic stimulation in *Tetrahymena pyriformis*. *Biochim. Biophys. Acta*, 805, 345-353.
- Weischer A., Freiburg M. and Heckmann K. 1985: Isolation and partial characterization of gamones 1 and 2 of *Euplotes octocarinatus*. *Abstr. VII Intern. Congr. Protozool., Nairobi, Kenya*, 72.

#### EXPLANATION OF PLATE I

Con A binding site fields (OFs) with horseradish peroxidase label on cells from mixtures with different proportions of members of opposite mating types. Upper row — proportion 1 : 1, lower row — proportion 1 : 100. Preparation see Materials and Methods. Bar — 10  $\mu\text{m}$





W. Lueken et B. Oelgemöller

auctores phot.





## Interaction Lead-Zinc in a Natural Community of Protozoans

Gregorio FERNANDEZ-LEBORANS  
and Maria Teresa ANTONIO-GARCIA

Laboratorio de Biología General, Facultad de Biología, Universidad  
Complutense, 28040 Madrid, Spain

Received on 30 October 1985

*Synopsis.* Using a natural community of *Protozoa*, with its environment contaminated with an array of increasing concentrations of lead and zinc, the effects of these two metals have been studied throughout the treatment in respect to: (a) the dynamics of the community, (b) the variability in the number of species and number of individuals of every species, and (c) some physico-chemical factors.

The effect of particular metals on biological systems has been the subject of many studies. Its main ecological significance is reached when these metals are found at toxic doses. Lethal or sublethal effects are shown by modification of the community structure in different ways: morphological, physiological, feeding cycle, growth rate, diversity, behaviour. Most of the investigations were carried out referring to: (1) The direct study of the area affected by this sort of contamination; (2) The use of experimental cultures of determined species to characterize the toxic quality of the environment. According to Cairns (1981) there are several factors which are necessary to understand in order to analyze these toxic effects, among them: (1) determination of the tolerance of population development in respect to determined chemical components, (2) estimation of the grade of transfer of the pollutant into biological processes. There are two aims which would be necessary to bring about: (1) Development of techniques to characterize the grade of contamination in the system, and (2) Improving of other techniques for contamination prediction.

The effect of lead on living organisms is well known. In higher vertebrates its uptake, either by digestive or by respiratory ways, leads

to its passage into the blood, which determines an interference in the synthesis of the hem units for the hemoglobine, leading in its turn to a reduction of the number of red cells and to a shortening of their life cycles. In addition, there is a clear interference with the kidney enzymes. To these facts, the metal accumulation in several tissues is added, specially in the pulmonary epithelium and the bone tissue, from where it can recirculate afterwards. Harmful effects of lead have been demonstrated not only in humans but also in different animals where it often caused an important rate of mortality. The lead effects on ciliate protozoa have been experimentally studied by means of cultures, including clonal ones, of selected species. For instance, it has been shown that in the case of *Colpidium campylum* the active minimal dose (AMD) of lead is 0.4 mg/l (Dive et Leclerc 1977).

According to Knoppert (1976), the maximal possible concentration of lead permissible in the drinking water is 50 µg/l. A study of lead accumulation in natural communities of ciliates has recently been carried out (Corpas-Vazquez et al. 1982, Fernandez-Leborans et al. 1982, 1985, Antonio-Garcia et al. 1983), with particular reference to particle size, their accumulation areas, community dynamics (species, individuals and some physico-chemical factors). Characterization of such communities (Corpas-Vazquez et al. 1983 a, b) pointed out the capacity of some species or groups of ciliate species to tolerate lead pollution.

Zinc is also a potentially dangerous metal (Goldberg 1973) and its effects on the aquatic organisms are well known. Thus, in accordance with Cairns and Scheier (1958), the lethal concentration for 50% of the population in one species of snail was 0.79-1.27 mg/l at 20°C and 0.62-0.78 mg/l at 30°C in soft water. The influence of the temperature on zinc toxicity at low concentrations is clearly shown in many species, both qualitatively and quantitatively (Pickering and Henderson 1966, Sprague 1970). The effect of high zinc concentrations in fish is separation of the branchial epithelium from its membranous base and, therefore, increasing of the distance for gas diffusion between water and blood (Skidmore and Tovell 1972). In addition, the lamellar circulation becomes blocked. These changes lead to a continuous decrease of arterial oxygen tension, which causes respiratory collapse and finally death (Skidmore 1970). A quick increase of the temperature causes stronger effects due to the increased respiratory rate (Burton et al. 1972). The zinc sublethal dose can give rise to histopathologic effects (Crandall and Goodnight 1963) or changes in cell enzymatic functions (Hiltibran 1971); even several steps in cycle life of fish can be inhibited (Brungs 1971). In accordance



with Cairns et al. (1975) more studies are necessary about zinc effects on invertebrates, especially on those which are food of fish. Experimental studies of zinc effects on ciliated protozoa in laboratory culture show that, for instance, the AMD for *Colpidium campylum* is 25 mg/l and the tolerable concentration for *Paramecium multimicronucleatum* is 0-56 mg/l (Ruthven and Cairns 1973). The maximal concentration allowable in drinking water is 100  $\mu\text{g/l}$ , after Knoppert (1976). A study of zinc action in a natural community of ciliated protozoa has recently been carried out (Fernandez-Leborans et al. 1983), with the analysis of biotic and physico-chemical variations together with the characterization of the community and finding out the indicative capacity of some species; in the same work the community was used to analyze, in addition, separately the lead and mercury effects, and thereby we compare the results of the isolated action of three different metals upon the same natural community. The next step in our study was to analyze the synergic effect of two metals (lead and zinc) on a community of protozoa living in a natural environment, especially on the dynamics of the population. The results exposed in this paper help to reach the forenamed main aims and therefore the characterization and prediction of this type of contamination is considered.

### Material and Methods

The specimens of different species of protozoa used in this study came from sample collections in Manzanares river, in La Pedriza (Madrid, Spain), near of its rise, presumably in an area not contaminated with lead. Once the samples were carried to the laboratory, the concentrations of lead, zinc and other heavy metals in the environment were measured and found to be not appreciable. The samples were enriched with sterilized wheat seeds (1 seed/50 ml) and kept at room temperature in the laboratory. In order to accomplish the study proper, the samples were divided into different recipients (200 ml each) when the number of species proved to be high enough. Lead acetate and zinc chloride were used in the following concentrations: Zn1, 20  $\mu\text{g/l}$ ; Zn2, 100  $\mu\text{g/l}$ ; Zn3, 200  $\mu\text{g/l}$ ; Zn4, 1000  $\mu\text{g/l}$ ; Pb1, 10  $\mu\text{g/l}$ ; Pb2, 50  $\mu\text{g/l}$ ; Pb3, 100  $\mu\text{g/l}$ ; Pb4, 500  $\mu\text{g/l}$ . These concentrations were then combined in all possible ways when added to the samples; a control was always used. Every three days the dissolved oxygen, pH and temperature were measured. In addition, every three days, the different ciliate species were identified with the following techniques: Protargol (Tuffrau 1967), silver carbonate ammoniacal pyridinate (Fernandez-Galiano 1976) and silver nitrate (Klein 1958). The individuals were counted in ten fractions, with 250 ml in each recipient. When the density of individuals was high, decimal dilutions were made. Six measurements were carried out on each one of these variables.

## Observations

## pH

The control shows an increase of pH in the first three days of the study and, from the second measurement the pH remains constant, around 7.5.

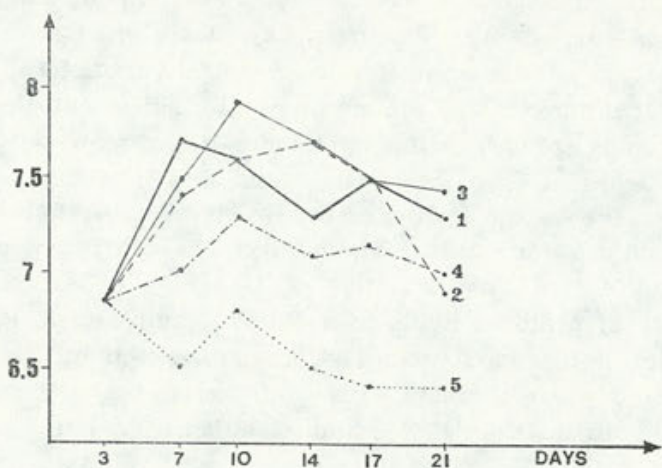

Fig. 1. The pH of the fractions: control (1), Pb1Zn1 (2), Pb1Zn2 (3), Pb1Zn3 (4), Pb1Zn4 (5)

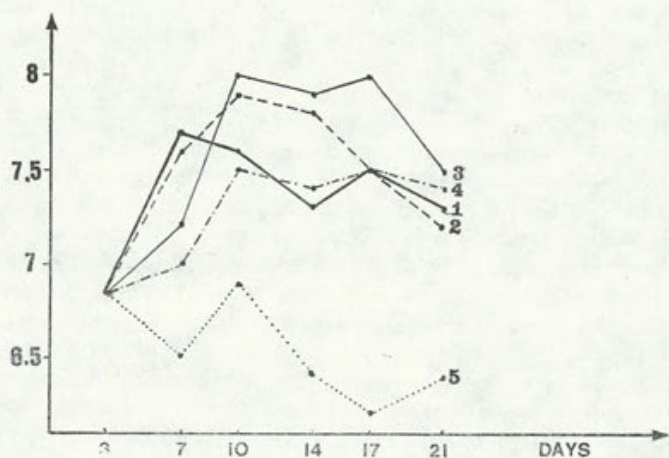

Fig. 2. The pH of the fractions: control (1), Pb2Zn1 (2), Pb2Zn2 (3), Pb2Zn3 (4), Pb2Zn4 (5)



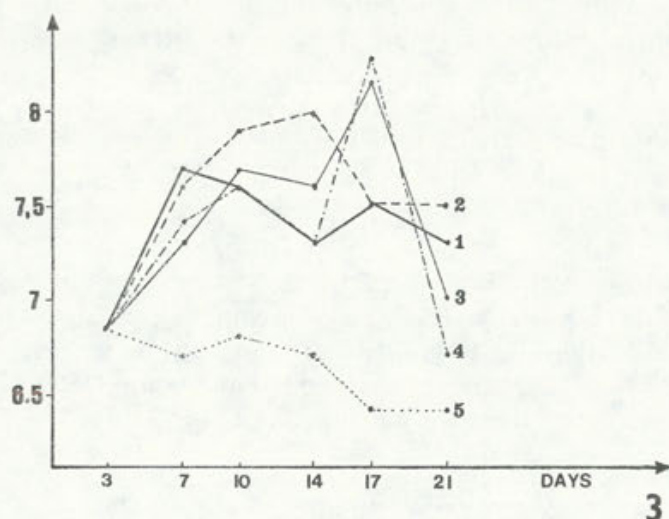

Fig. 3. The pH of the fractions: control (1), Pb3Zn1 (2), Pb3Zn2 (3), Pb3Zn3 (4), Pb3Zn4 (5)

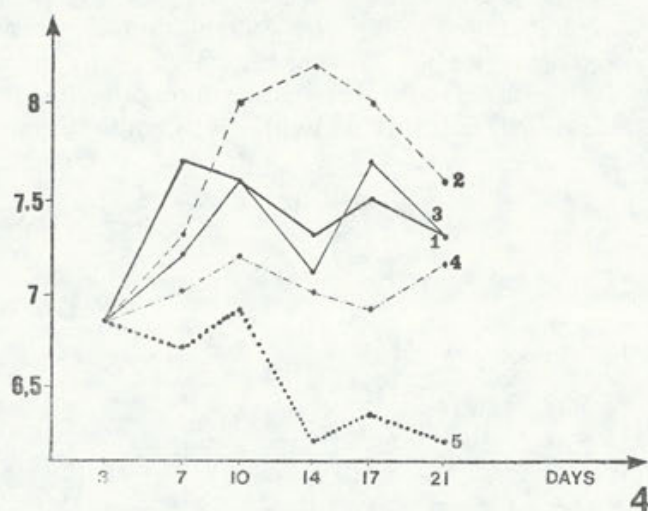

Fig. 4. The pH of the fractions: control (1), Pb4Zn1 (2), Pb4Zn2 (3), Pb4Zn3 (4), Pb4Zn4 (5)

All fractions with Zn1 (20  $\mu\text{g/l}$ ) show a pH increase in respect to the control; this increase is higher the higher is the lead concentration added to the environment in the mixture: for instance, with Pb1Zn1 the pH maximum is 7.7 in the fourth measurement, while with Pb4Zn1 it is 8.2 in the same day. In fractions with Zn2, higher pH values are always found than in fractions with Zn3, independent of the lead con-

centration in the mixture; generally, the pH does not differ here much from the control values, excepting that for the fifth measurement, in the recipient with Pb3.

In fractions with Zn4, the pH values differ notoriously from control values and they decrease near the end of treatment, showing a slight recuperation at the third measurement (Figs. 1-4).

### Temperature and Dissolved Oxygen

No important variations in these parameters occurred in samples with metals during the treatment, as compared with the controls. In all the recipients the temperature oscillated from 14°C to 21.4°C and the dissolved oxygen from 8.9 mg/l to 10.4 mg/l (Tables 1 and 2).

### Population Dynamics

#### Number of Species and Individuals Throughout the Treatment

Table 3 shows the list of species found. In the control (Fig. 5), there is a decrease in the number of species and individuals throughout the treatment although they do not disappear absolutely (at the end of this study two species persisted, *Spirostomum ambiguum* with 8 individuals and *Prorodon hispanicus* with 12 individuals/10 ml). The strongest de-

Table 1  
The temperature of the fractions throughout the treatment

	3	7	10	14	17	21
Control	14	20.7	19.5	20.5	20.2	19.5
Pb1Zn1	14	21.2	19.5	19.5	20.5	19.5
Pb1Zn2	14	21.0	20	19.5	20	19.5
Pb1Zn3	14	21.3	20	19.7	20.5	19.5
Pb2Zn1	14	21.2	20	20	20	19.5
Pb2Zn2	14	21.2	20	20	19.5	19.5
Pb2Zn3	14	21.2	20	19.5	20.5	19.5
Pb2Zn4	14	21.2	19.5	19.5	20.5	19.5
Pb3Zn1	14	21.3	20	19	21	19.5
Pb3Zn2	14	21.0	19.5	19.5	20	19.5
Pb3Zn3	14	21.2	20	19	20.2	19.5
Pb3Zn4	14	21.0	20	19.5	20.5	19.5
Pb4Zn1	14	21	19.5	20	21	19.5
Pb4Zn2	14	21.4	20.5	20	21	19.5
Pb4Zn3	14	21.2	19.5	19	20	19.5
Pb4Zn4	14	21.2	19.5	19.5	20	19.5



Table 2

The dissolved oxygen (mg/l) of the fractions throughout the treatment

	3	7	10	14	17	21
Control	10.4	9	9.2	9.3	9.2	9.3
Pb1Zn1	10.4	9	9.25	9.1	9.1	9.25
Pb1Zn2	10.4	8.9	9.25	9.25	9.1	9.25
Pb1Zn3	10.4	9	9.2	9.25	9.2	9.25
Pb1Zn4	10.4	8.9	9.2	9.3	9.1	9.25
Pb2Zn1	10.4	8.9	9.2	9.2	9.2	9.25
Pb2Zn2	10.4	8.9	9.2	9.2	9.25	9.25
Pb2Zn3	10.4	8.9	9.2	9.25	9.1	9.25
Pb2Zn4	10.4	8.9	9.25	9.25	9.1	9.25
Pb3Zn1	10.4	8.9	9.2	9.3	9	9.25
Pb3Zn2	10.4	9	9.25	9.25	9.2	9.25
Pb3Zn3	10.4	8.9	9.2	9.3	9.1	9.25
Pb3Zn4	10.4	9	9.2	9.25	9.1	9.25
Pb4Zn1	10.4	9	9.25	9.2	9	9.25
Pb4Zn2	10.4	8.9	9.1	9.2	9	9.25
Pb4Zn3	10.4	8.9	9.2	9.25	9.2	9.25
Pb4Zn4	10.4	8.9	9.25	9.3	9.2	9.25

Table 3

The list of species found

(1) <i>Vorticella microstoma</i>	(12) <i>Epalxella mirabilis</i>
(2) <i>Stylonychia mytilus</i>	(13) <i>Frontonia leucas</i>
(3) <i>Chilodonella cucullulus</i>	(14) <i>Holophrya matritensis</i>
(4) <i>Litonotus lamella</i>	(15) <i>Metopus striatus</i>
(5) <i>Halteria grandinella</i>	(16) <i>Paramecium bursaria</i>
(6) <i>Spirostomum teres</i>	(17) <i>Climacostomum virens</i>
(7) <i>Spirostomum ambiguum</i>	(18) <i>Keronopsis monilata</i>
(8) <i>Amoeba</i> sp.	(19) <i>Caenomorpha medusula</i>
(9) <i>Holophrya castellanum</i>	(20) <i>Urostyla grandis</i>
(10) <i>Prorodon hispanicus</i>	(21) <i>Protospathidium</i> sp.
(11) <i>Histiculus muscorum</i>	(22) <i>Actinosphaerium</i> sp.

crease occurred between the fourth and fifth measurement, from 8 to 2 species and from 166 to 27 individuals (number of individuals in 10 ml).

In the fraction Pb1Zn1 (Fig. 6) there is a progressive decrease of individual and species numbers throughout the treatment, with some stabilization of the number of species between the second and third measurements. No ciliates appeared in the last measurement.

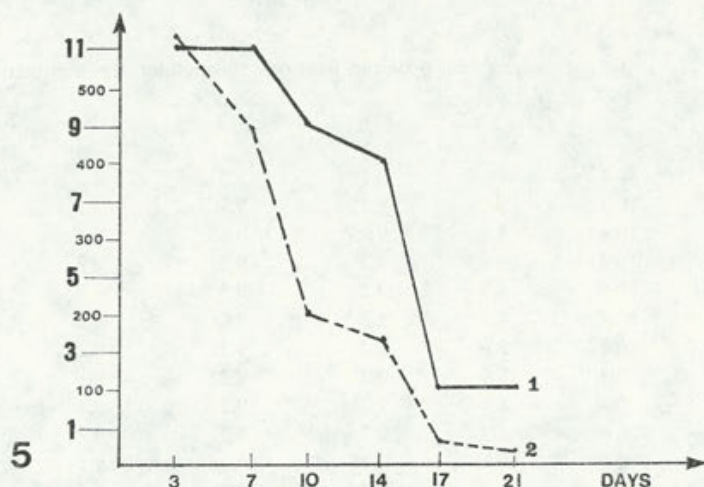

Fig. 5. Number of species (1) and individuals (2) in the control

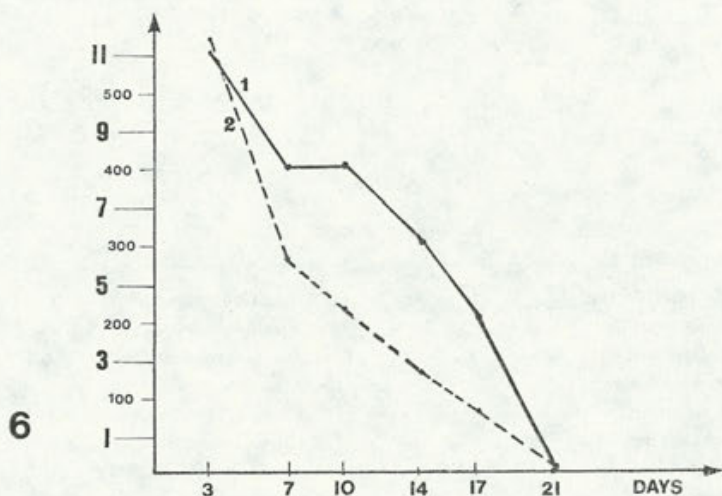

Fig. 6. Number of species (1) and individuals (2) in the fraction Pb1Zn1

In the fraction Pb1Zn2 (Fig. 7), few days after the beginning of treatment, a quicker disappearance of most species in respect to the preceding fraction occurred (in the third measurement of Pb1Zn1 there were 8 species and in Pb1Zn2 there were 4 species). In the fifth measurement no vegetative forms were found, but in the next measurement *Actinosphaerium* sp. with 12 individuals appeared.

In the fractions Pb1Zn3 and Pb1Zn4 (Fig. 8) the addition of metals promotes a rapid extinction of all vegetative forms, which never re-appeared until the end of the treatment.



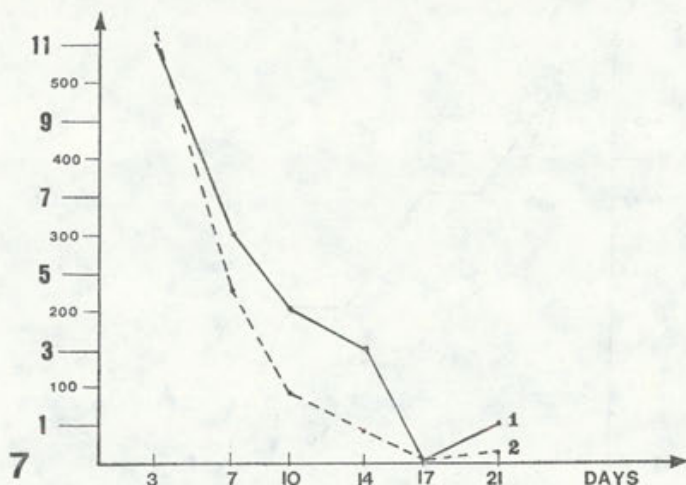

Fig. 7. Number of species (1) and individuals (2) in the fraction  $Pb_1Zn_2$

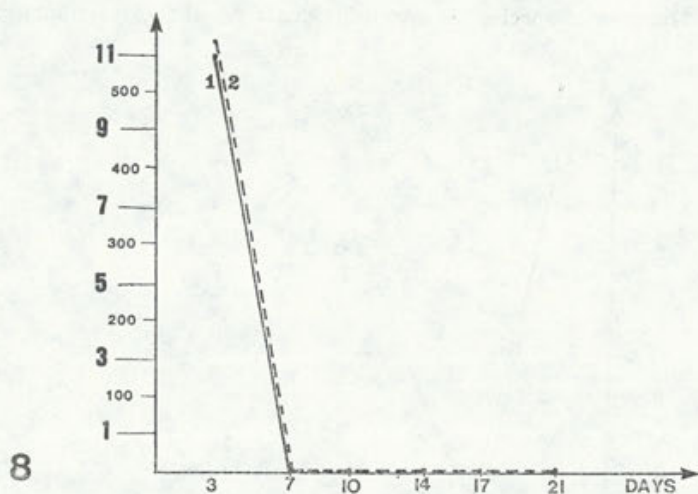

Fig. 8. Number of species (1) and individuals (2) in the fractions  $Pb_1Zn_3$ ,  $Pb_1Zn_4$ ,  $Pb_2Zn_4$ ,  $Pb_3Zn_4$ ,  $Pb_4Zn_4$

The species and individual numbers in fraction  $Pb_2Zn_1$  (Fig. 9) gradually decrease until the sixth measurement where they reach zero. The number of species between the second and third measurements is constant (8), as between the fourth and fifth (5).

In the fraction  $Pb_2Zn_2$  (Fig. 10) no species appears from the fifth measurement. There is an important decrease of the number of species and individuals after metal addition (from 11 species and 563 individuals at the first measurement to 2 species and 44 individuals at the second measurement). There is a little recuperation at the third measurement (5 species and 122 individuals).

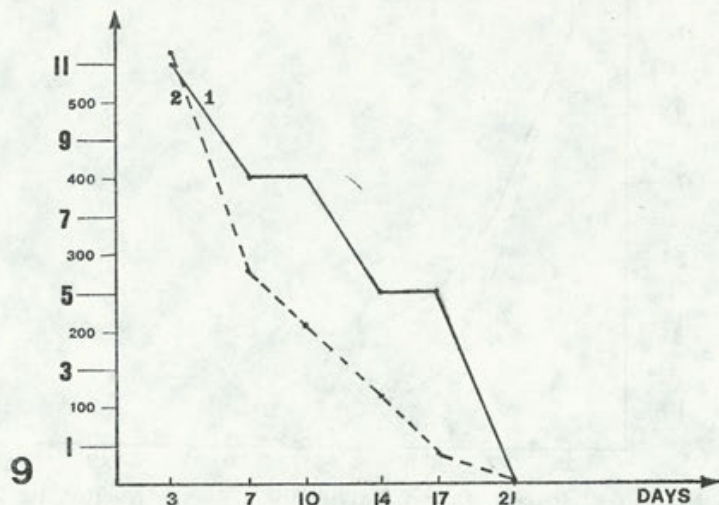

Fig. 9. Number of species (1) and individuals (2) in the fraction Pb2Zn1

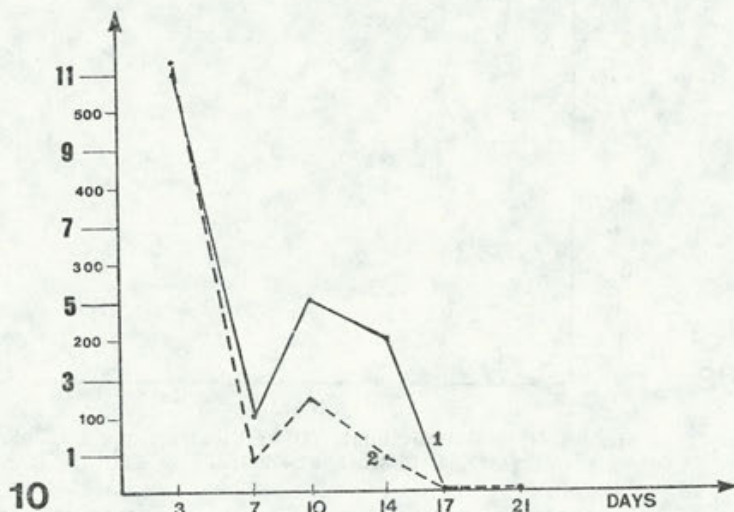

Fig. 10. Number of species (1) and individuals (2) in the fraction Pb2Zn2

In the fraction Pb2Zn3 (Fig. 11) there is an important reduction of the number of species and individuals after adding the metals (2 species and 33 individuals at the second measurement); all species disappear as early as the third measurement. No species has been found in the fraction Pb2Zn4 (Fig. 8) after adding the metals throughout the treatment. In the fraction Pb3Zn1 (Fig. 12), there is one species which survives to the treatment: *Paramecium bursaria*, which shows 8 individuals at



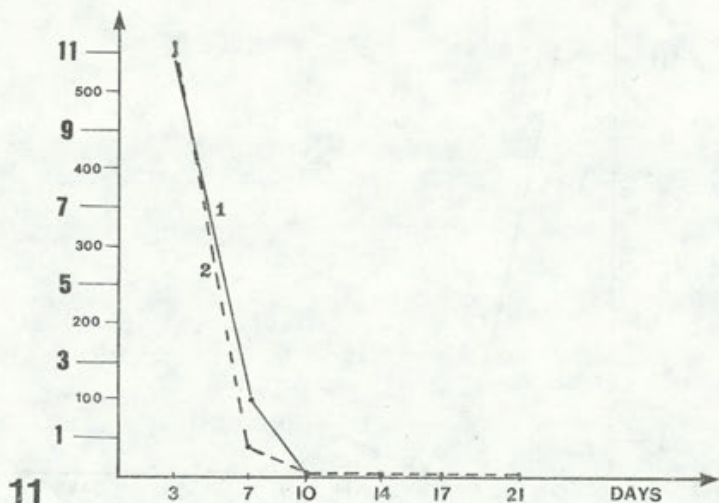

Fig. 11. Number of species (1) and individuals (2) in the fraction Pb<sub>2</sub>Zn<sub>3</sub>

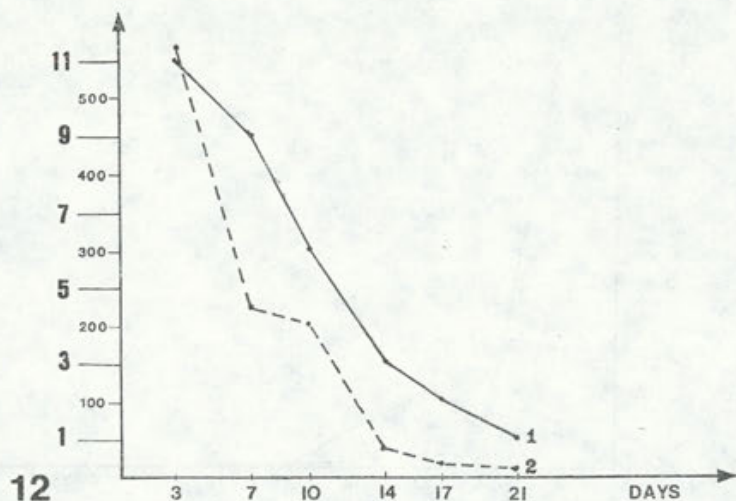

Fig. 12. Number of species (1) and individuals (2) in the fraction Pb<sub>3</sub>Zn<sub>1</sub>

the sixth measurement. There is a remarkable decrease in the number of both species and individuals after adding the metals in the fraction Pb<sub>3</sub>Zn<sub>2</sub> (Fig. 13), even a complete disappearance of ciliates at the third measurement. Then, *Epalxella mirabilis* with 5 individuals appeared at the fourth measurement. No vegetative form was observed after that.

In the fraction Pb<sub>3</sub>Zn<sub>3</sub> (Fig. 14), the decrease was a little more abrupt than in the preceding fraction between the first and second meas-

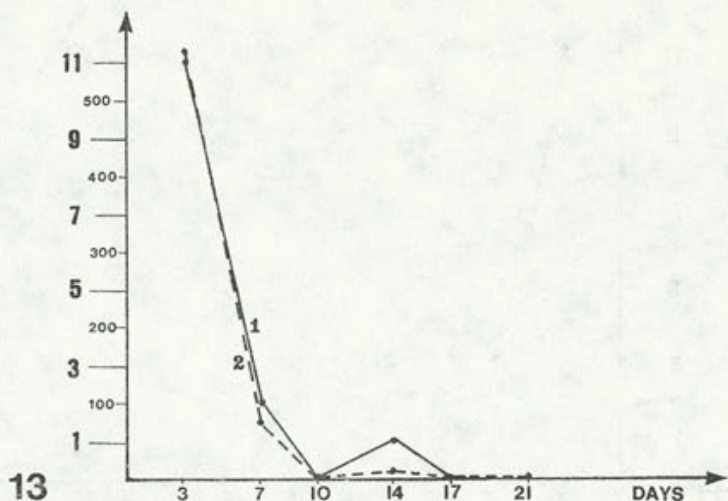

Fig. 13. Number of species (1) and individuals (2) in the fraction  $Pb_3Zn_2$

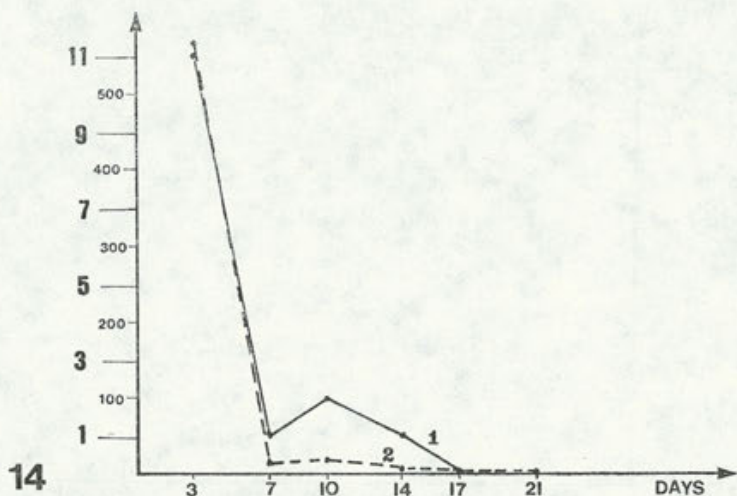

Fig. 14. Number of species (1) and individuals (2) in the fraction  $Pb_3Zn_3$

urement, although some vegetative forms remained until the fifth measurement. After adding the metals, no species appeared in the  $Pb_3Zn_4$  fraction (Fig. 8).

In the fraction  $Pb_4Zn_1$  (Fig. 15), at the second measurement, there was only one species, *Spirostomum teres*, with 21 individuals; at the third measurement, no vegetative forms have been found, but they appeared again at the fourth measurement, with *Spirostomum ambi-*



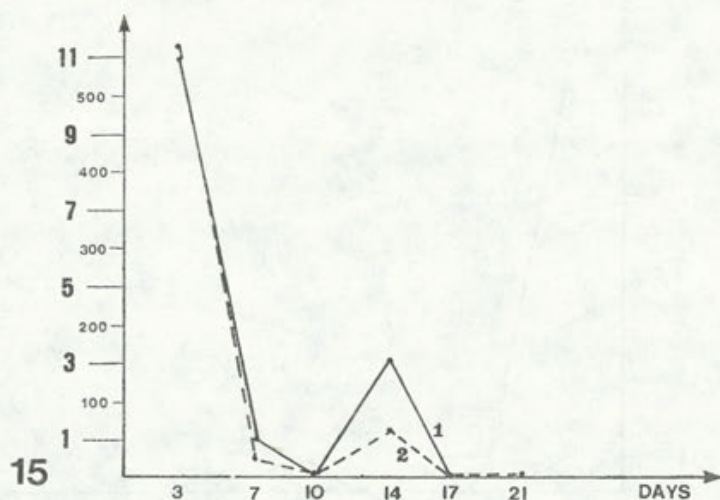

Fig. 15. Number of species (1) and individuals (2) in the fraction Pb4Zn1

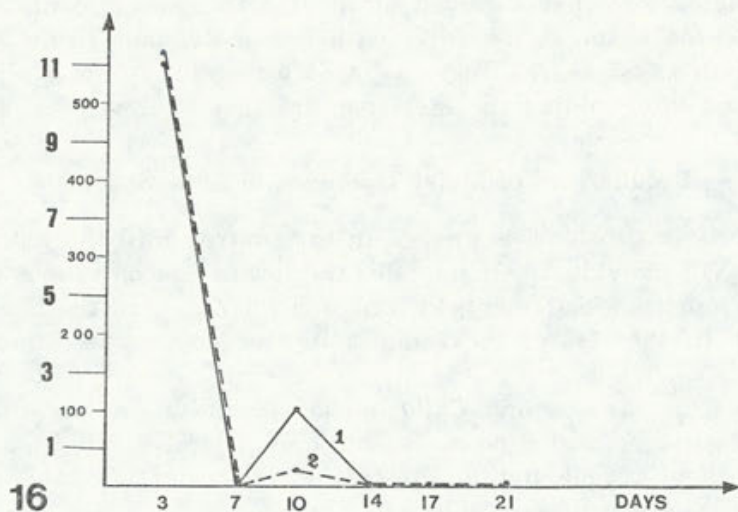

Fig. 16. Number of species (1) and individuals (2) in the fraction Pb4Zn2

*guum* and *Prorodon hispanicus*. From the fifth measurement, no protozoa have been found.

After adding the metals, all vegetative forms disappeared from the fraction Pb4Zn2 (Fig. 16). However, at the third measurement, *Spirostomum teres* and *Prorodon hispanicus* reappeared, disappearing again since the fourth measurement. In the fraction Pb4Zn3 (Fig. 17), at the second and third measurements, only *Keronopsis monilata* was found.

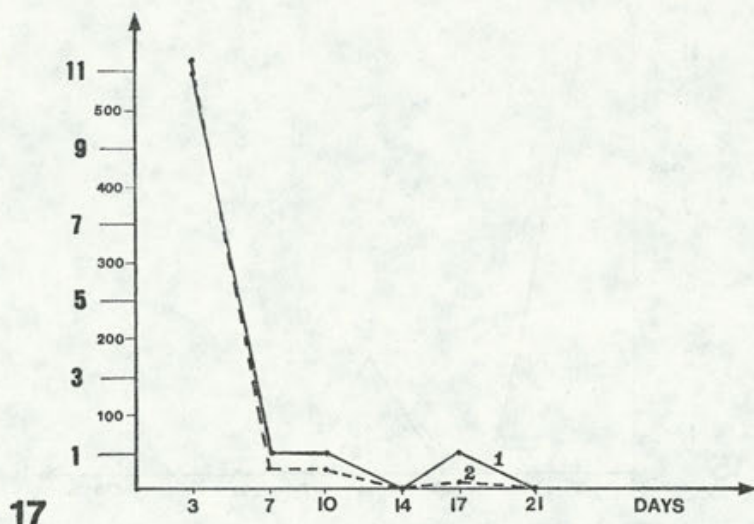

Fig. 17. Number of species (1) and individuals (2) in the fraction Pb4Zn3

These ciliates were not observed at the fourth measurement, although they appeared again at the fifth, with less individuals (from 32 to 8). At the sixth measurement, there were no vegetative forms. No protozoa were found after adding the metals in fraction Pb4Zn4 (Fig. 8).

#### Peculiarities of Metal Tolerance in some Species

*Vorticella microstoma* is present in the control until the fourth measurement (18 individuals). It tolerates the lowest concentrations (Pb1Zn1 until the fourth measurement, Pb1Zn2 and Pb2Zn2 until the third measurement). In the rest of the samples it does not appear after adding the metals.

*Stylonychia mytilus* and *Chilodonella cucullulus* are present in the control until the fourth measurement; they tolerate high lead concentrations (they were found in Pb2Zn1, Pb2Zn2 and Pb3Zn1) but they cannot tolerate more than 100 µg/l of Zn.

*Litonotus lamella*, *Epalxella mirabilis*, *Caenomorpha medusula*, *Urostyla grandis* and *Amoeba* sp. do not tolerate metals in the environment, even at the lowest concentrations used.

*Spirostomum teres* is present in the control until the fourth measurement. It is resistant to high concentrations of both metals. It tolerates lead concentrations up to 500 µg/l (it appears at the third measurement in Pb4Zn2), but it only tolerates until 200 µg/l of Zn. (It does not appear in any of the fractions with Zn4, but it is found at the fourth measurement in Pb3Zn3).



The behaviour of *Spirostomum ambiguum* is similar, although it is less resistant (they only reach the third measurement in Pb3Zn3). *Holophrya castellanum* is extinct at lead concentrations higher than 10 µg/l and zinc concentrations higher than 100 µg/l. *Histiculus muscorum* and *Holophrya matritensis* can only live in lead concentrations under 100 µg/l for a short time. However, zinc is limitant for these species: they survive only in fractions up to 20 µg/l of zinc.

*Frontonia leucas* does not tolerate higher concentrations than Pb2Zn2 or Pb3Zn1. *Paramecium bursaria* can survive higher lead concentrations even until the last measurement (Pb3Zn1). However, it does not tolerate more than 20 µg/l of zinc. *Keronopsis monilata* is one of the most resistant species found. It survives nearly until the end of the experiment in fractions with 500 µg/l of lead and 200 µg/l of zinc.

### Conclusions

We found that zinc and lead, acting together, are not tolerated by the following species: *Litonotus lamella*, *Epalxella mirabilis*, *Caenomorpho medusula*, *Urostyla grandis* and *Amoeba* sp. They could therefore be used as indicator of the absence of these metals from the environment. This fact contradicts previous descriptions where some of these species (*Caenomorpho medusula*, *Epalxella mirabilis*) were found in environments with high pollution (polysaprobic area, Bick 1972).

Another group of species, which could indicate the absence of medium and high concentrations of both metals, is formed by: *Vorticella microstoma*, *Holophrya castellanum*, *Histiculus muscorum*, *Holophrya matritensis* and *Frontonia leucas*.

Some other species with high tolerance for medium and high concentrations of both metals (*Paramecium bursaria* and *Spirostomum ambiguum*) are similarly tolerant to high concentrations of each metal separately, as it has been already shown (Corpas-Vazquez et al. 1982 a, b, Fernandez-Leborans et al. 1983, 1984); thus, they cannot be used as metal indicators.

Summarizing, the ion more limitant in this interaction Pb-Zn seems to be zinc; it determine that many species gradually disappear when its concentration rises. On the other hand, the ciliate population, in general, tolerates lead better than zinc.

### ACKNOWLEDGEMENTS

The authors thank Dr. Igor B. Raikov for his assistance in the elaboration of this work.

## REFERENCES

- Antonio-García M. T., Fernández-Leborans G., Corpas-Vázquez I. 1983: La localización morfológica de tres metales: plomo, zinc y mercurio en una comunidad de protozoos ciliados. VI Biental de la Real Sociedad Española. Hist. Nat., Santiago de Compostela.
- Bick H. 1972: Ciliated Protozoa: an illustrated guide to the species used as biological indicators in freshwater biology. World Health Organization, Geneva, 198 pp.
- Brungs W. A. 1971: Chronic toxicity of zinc to the fathead minnow, *Pimephales promelas*. Trans. Am. Fish. Soc., 98, 272-279.
- Burton D. T., Morgan E. I., Cairns J. Jr. 1972: Mortality curves of bluegills (*Lepomis macrochirus* Rafinesque) simultaneously exposed to temperature and zinc stress. Trans. Am. Fish. Soc., 101, 435-441.
- Cairns J. Jr. 1981: Biological monitoring. Part VI — future needs. Water Res., 15, 941-952.
- Cairns J. Jr., Scheier A. 1958: The effects of temperature and hardness of water upon the toxicity of zinc to the pond snail, *Physa heterostropha* (Say). Not. Nat. Acad. Nat. Sci. Phila, 308, 1-11.
- Cairns J. Jr., Heath A. G., Parker B. C. 1975: The effects of temperature upon the toxicity of chemicals to aquatic organisms. Hydrobiol. Bull, 47, 135-171.
- Corpas-Vázquez I., Fernández-Leborans G., Antonio-García M. T. 1982: Efectos del plomo en algunas comunidades de protozoos. II. Los ciliados de la Ciudad Universitaria (Madrid). I Congreso Nacional de Protección de la Naturaleza y del Medio Humano, C.S.I.C., Madrid.
- Corpas-Vázquez I., Fernández-Leborans G., Antonio-García M. T. 1983a: La caracterización bioindicadora respecto al plomo de una comunidad de protozoos ciliados de la Ciudad Universitaria, Madrid. VI Biental de la Real Sociedad Española de Historia Natural, Santiago de Compostela.
- Corpas-Vázquez I., Fernández-Leborans G., Antonio-García M. T. 1983b: La caracterización bioindicadora respecto al plomo de una comunidad de protozoos ciliados del embalse de Santillana, Madrid. VI Biental de la Real Soc. Español. de Historia Natural, Santiago de Compostela.
- Crandall C. A., Goodnight C. J. 1963: The effects of sublethal concentrations of several toxicants to the common guppy, *Lebistes reticulatus*. Trans. Am. Microsc. Soc., 82, 59-73.
- Dive D., Leclerc H. 1977: Utilisation du protozoaire cilié *Colpidium campylum* pour la mesure de la toxicité et de l'accumulation des micropolluants: analyse critique et applications. Environ. Pollut., 14, 169-186.
- Fernández-Galiano D. 1976: Silver impregnation of ciliated Protozoa: procedure yielding good results with the pyridinated silver carbonate method. Trans Am. Microsc. Soc., 95, 557-560.
- Fernández-Leborans G., Corpas-Vázquez I., Antonio-García M. T. 1982: Efectos del plomo en algunas comunidades de Protozoos. I. Los ciliados de Manzanares El Real. I Congreso Nacional de Protección de la Naturaleza y del Medio Humano, C.S.I.C., Madrid.
- Fernández-Leborans G., Antonio-García M. T., Corpas-Vázquez I. 1983: Les effets de trois types de cations sur une communauté de Protozoaires Ciliés. J. Protozool., 30, 249 (abstr.).
- Fernández-Leborans G., Antonio-García M. T., Corpas-Vázquez I. 1985: The effects of lead on some protozoan communities. Ciliates of the Santillana reservoir and Ciudad Universitaria (Madrid, Spain). Acta Protozool. (in press).
- Goldberg A. J. 1973: A survey of emissions and controls for hazardous and other pollutants. U.S. Environ. Protec. Agen. NTIS PB-223-568.
- Hiltibran R. C. 1971: Effects of cadmium, zinc, manganese, and calcium on oxygen and phosphate metabolism of bluegill liver mitochondria. J. Water Pollut. Control. Fed., 818-823.
- Klein B. M. 1958: The "dry" silver method and its proper use. J. Protozool., 5, 99-103.



- Knoppert P. L. 1976: Quality criteria for surface water to be treated to drinking water. *Int. Stan. Comm. Pollut. Protec. Wat. Sour.* 1, L1-L5.
- Pickering Q. H., Henderson C. 1966: The acute toxicity of some heavy metals to different species of warm water fishes. *Int. J. Air Wat. Pollut.*, 10, 453-463.
- Ruthven J. A., Cairns J. Jr. 1973: Response of fresh-water protozoan artificial communities to metals. *J. Protozool.*, 20, 127-135.
- Skidmore J. F. 1970: Respiration and osmoregulation in rainbow trout with gills damages by zinc sulfate. *J. Exp. Biol.*, 52, 481-494.
- Skidmore J. F., Tovell P. W. A. 1972: Toxic effects of zinc sulphate on the gills of rainbow trout. *Water Res.*, 6, 217-230.
- Sprague J. B. 1970: Measurement of pollutant toxicity to fish. II. Utilizing and applying bioassay results. *Water Res.*, 4, 3-32.
- Tuffrau M. 1967: Perfectionnements et pratique de la technique d'imprégnation au protargol des infusoires ciliés. *Protistologica*, 3, 91-98.





Eugregarine Parasites of *Coleoptera* from North-East Region  
of Karnataka. IV. *Steinina rodgii* sp. n., Found in the Gut  
of *Scleron reitteri* Gb.

C. C. PATIL and S. D. AMOJI

Department of P. G. Studies and Research in Zoology, Gulbarga University,  
Gulbarga 585 106, India

Received on 25 June 1985, revised on 21 August 1985

*Synopsis.* This paper deals with the description of morphological features of various stages in the development of a gregarine species, *Steinina rodgii* sp. n., infecting tenebrionid beetle, *Scleron reitteri* Gb., prevailing in Gulbarga University Campus, Gulbarga. The study also includes the seasonal incidence of infection of this gregarine.

Genus *Steinina* was created by Léger and Duboscq (1904) to include a gregarine species, *Steinina ovalis* (Stein). The generic characteristics of this genus as stated by these authors are: (1) sporonts solitary, (2) epimerite a short retractile digitiform process in the early stage and later becoming flattened transparent button-like, (3) cysts spherical and dehiscence by simple rupture and (4) sporocysts biconical. Later, Ashworth and Rettie (1913), Ishii (1914), Watson (1915, 1916), Zwetkoff (1929), Foerster (1938), Hoshida (1952, 1953), Obata (1953), Théodoridès and Jolivet (1959), Uttangi and Desai (1962), Théodoridès and Desportes (1966) and Théodoridès et al. (1972) have contributed many species to this genus. A chronological list of the gregarine species alongwith the hosts and locality is given in Table 1. The study undertaken on the faunistic exploration of eugregarine parasites of *Coleoptera* from North-East region of Karnataka revealed a species of *Steinina* infecting tenebrionid beetle, *Scleron reitteri*. For the various reasons mentioned in the text of this paper the species is considered new to science.

Table 1  
Chronological list of gregarine species retained in the genus *Steinina*

Name of the species	Host(s)	Locality
<i>S. ovalis</i> (Stein) Léger and Duboscq (1904)	<i>Tenebrio molitor</i> L. larvae	France
<i>S. rotundata</i> Ashworth and Reittie (1913)	<i>Ceratopsyllus styx</i>	Edinburgh
<i>S. obconica</i> Ishii (1914)	<i>Tribolium ferruginum</i> F.	Japan
<i>S. rotunda</i> Watson (1915)	<i>Amara angustata</i> Say	USA
<i>S. harpali</i> Watson (1916)	<i>Harpalus pennsylvanicus longoir</i> (Kirby)	Urbana
<i>S. ellipsoidalis</i> Zwetkow (1929)	<i>Phyllotreta undulata</i> (Coleoptera larvae)	Germany
<i>S. diaperis</i> Foerster (1938)	<i>Diaperis boleti</i> (Coleoptera)	Germany
<i>S. sphaerospora</i> Hoshide (1952)	<i>Tenebrio piriipes</i> Herbst.	Japan
<i>S. minor</i> Obata (1953)	<i>Tenebrionidae</i> larvae	Japan
<i>S. termites</i> Uttangi and Desai (1962)	Termite	India
<i>S. dollfusi</i> Théodoridès and Desportes (1966)	<i>Caropria subocellata</i> Lap. <i>Encyrtus anthraeinus</i> Kr.	Guinea
<i>S. amarygmi</i> Théodoridès et al. (1972)	<i>Amarygmus morio</i> Fab.	Baiyer river
<i>S. maxima</i> Théodoridès et al. (1972)	<i>Gymnopholus gressitti</i> Mersh.	Baiyer river

## Material and Methods

Beetles were collected from various localities in and around the Gulbarga University Campus, Gulbarga. These were dissected and their entire alimentary canal was taken out on a slide. The smears were made alongwith the intestinal juice and examined for gregarine infection.

The parasites were studied best in living conditions in the gut fluid contents to which a few drops of insect Ringer's or normal saline was added. Supravital stains like Lugol's iodine was used in dilute condition for the detection of various stages of gregarine development.

Smears heavily laden with parasites were fixed in Carnoy's fluid or absolute alcohol for making stained preparations following Heidenhain's iron alum haematoxylin procedure. The gametocysts encountered in the gut smears were collected by means of micropipette and transferred to a moist chamber to which the gut fluid and insect Ringer's solution were added. The development of gametocysts occurred till sporulation. Histological preparations of the heavily infected whole intestine were made for the study of intra/intercellular developmental stages of the gregarine, if any.

The illustrations presented in this paper are camera lucida drawings. The measurements of live specimens and permanent preparations were made by calibrated eyepiece.



## Observations

The host *Scleron reitteri* harbours three species of gregarines belonging to three different genera; *Steinina*, *Xiphocephalus* and *Gregarina*. Though the site of infection of all three gregarine species is mid-intestine, they vary considerably in their seasonal intensity; *Xiphocephalus* prevailing throughout the year, *Gregarina* only during March to June and *Steinina* from September to December. The detailed description of *Xiphocephalus* and *Gregarina* species is given elsewhere (Patil 1982).

*Steinina rodgii* infects, on the average, about 9% insect hosts. The infection is observed to be maximum (16%) during November and minimum (4%) in September (Fig. 2).

**Cephalonts:** There is no intra/interepithelial development at any stage in the life cycle of the gregarine. The youngest cephalont (Fig. 1 A) encountered in the smears of the gut contents has oval body and measures about 30  $\mu\text{m}$ . The epimerite in it is short retractile digitiform process and is embedded in sarcocyst of the epicyte. The protomerite is hemispherical in shape; broad at the base where it is separated from the deutomerite by a concave thin septum. The protomerite width is greater (20  $\mu\text{m}$ ) than the height (12  $\mu\text{m}$ ). Due to the presence of compact granules in its endoplasm it always stains deeply. The deutomerite shape varies from ovoidal to conical, being wide just below the shoulder. The

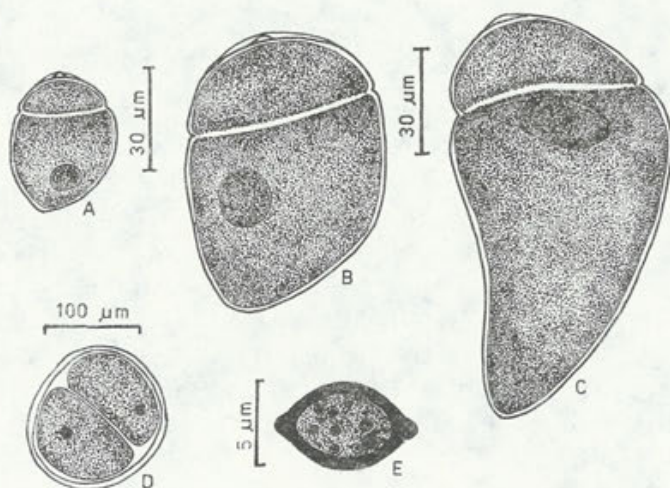

Fig. 1. *Steinina rodgii* sp. n. Camera lucida drawings of different stages of the development. A — Early cephalont with epimerite embedded in the sarcocyst, B — Advanced cephalont, C — Sporadin. Note the presence of sarcocyst at the tip of the protomerite, D — Freshly formed gametocyst, E — Biconical sporocyst

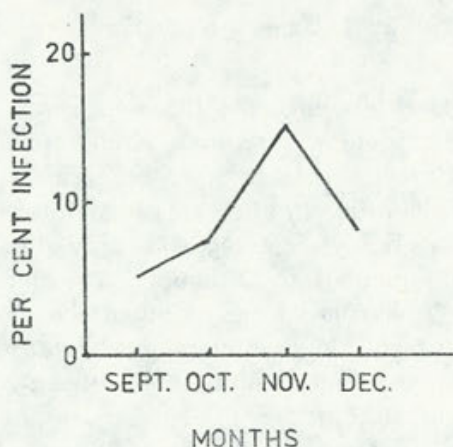

Fig. 2. Graph showing the incidence of infection

nucleus is spherical measuring 5-6  $\mu\text{m}$  in diameter. As the development progresses (Fig. 1 B), the sarcocyst of epicyte in the epimerite increases in width and covers more than a half of the protomerite's tip. The protomerite and deutomerite also increase in their sizes proportionately.

**Sporadins:** The sporonts are small and solitary. They are stout-bodied and obese in shape (Fig. 1 C). The maximum length is 150  $\mu\text{m}$  and width 95  $\mu\text{m}$ . The various ratios are: PL : TL, 1 : 3.8 and PW : DW, 1 : 1.2. The protomerite is almost hemispherical, its width being greater (55  $\mu\text{m}$ ) than the height (20  $\mu\text{m}$ ). The deutomerite is conoidal or obese, widest at shoulder and tapering obliquely and gradually to a blunt end giving it a characteristic mango-like appearance. The nucleus is oval in shape and measures 25  $\mu\text{m}$   $\times$  22  $\mu\text{m}$ . It is always located in the anterior half of the deutomerite.

**Gametocysts:** Most of the gametocysts (Fig. 1 D) are recovered from the posterior part of the mid intestine. In an early cyst two gamonts and a line of association are clearly visible. Cyst wall is smooth and is about 10  $\mu\text{m}$  thick. These cysts are spherical, white and opaque, measuring 150  $\mu\text{m}$  in diameter. When subjected to moist chamber, they dehiscence by simple rupture on the 3rd day (Fig. 1 E) of their development.

**Sporocysts:** Sporocysts (Fig. 1 E) are biconical and pot-bellied. They measure 8  $\mu\text{m}$   $\times$  6  $\mu\text{m}$ . Eight sporozoites are seen in each sporocyst.

### Discussion

Solitary nature of the sporonts, epimerite digitiform, cysts dehiscing by simple rupture justify their inclusion in the family *Actinocephalidae* Léger.



Further, the specific characteristics, like short and flattened simple epimerite and bioconical sporocysts observed in this gregarine assign it to the genus *Steinina* Léger and Duboscq.

Among thus far known *Steinina* species, the presently described gregarine resembles, only in respect of its body shape, *S. minor* Obata (1953) and *S. sphaerospora* Hoshide (1952). However, the newly described gregarine species is quite different in its various body dimensions, cyst and sporocyst sizes nowhere comparable with those of *S. minor* and *S. sphaerospora* (Table 2). By possessing several unique features

Table 2

Comparative characteristics of *Steinina* spp. to show distinctiveness of *S. rodgii* sp. n.

Comparative characteristics	<i>S. minor</i> Obata	<i>S. sphaerospora</i> Hoshide	<i>S. rodgii</i> sp. n.
Body shape	Small, obese, 72 $\mu$ m	Solitary, obese, 240 $\mu$ m	Small, solitary, obese, 150 $\mu$ m
Epimerite	Little valuable cone	Spherical with short stalk	Short retractile digitiform
Protomerite	Hemispherical	Dome-shaped	Hemispherical
PL:TL ratio	1:3.3-7.2	1:2.8-4.5	1:3.8
PW:DW ratio	1:1.0-3.0	1:1.0-1.2	1:1.2
Nucleus	Spherical	Spherical	Spherical
Gametocysts	Spherical 65 $\mu$ m diameter	Ovoidal to spherical, 100-140 $\mu$ m diameter	Spherical 150 $\mu$ m diameter
Sporocysts	—	Spherical, 11 $\mu$ m in diameter, 8 sporozoites	Biconical, 8 $\mu$ m $\times$ 6 $\mu$ m, 8 sporozoites
Host	<i>Tenebrionidae</i> larvae	<i>Tenebrio picipes</i> Herbst.	<i>Scleron reitteri</i> Gb.
Locality	Hiroshima, Japan	Hikeru, Japan	Gulbarga, India

this gregarine differs from other known *Steinina* species. For these reasons it is considered new to protozoological literature and the name *Steinina rodgii* sp. n. is proposed. The specific name is chosen in honour of Dr. S. S. Rodgi, former Head of the Department of Microbiology Gulbarga University, Gulbarga, who has contributed much to the knowledge of protozoology.

## REFERENCES

- Ashworth J. H. and Reittie T. 1913: On a gregarine *Steinina rotundata*, nov. sp., present in the mid-gut of bird fleas of the genus *Ceratophyllus*. Proc. R. Soc. Lond., 86, 31-38.
- Foerster H. 1938. Gregarines in schlesischen Insekten. Z. Parasitenkd., 10, 157-209.
- Hoshide H. 1952: Studies on gregarines parasitic in Japanese insects II. Zool. Mag. (Tokyo), 91, 269-274.

- Hoshide H. 1953: Studies on gregarines parasitic in Japanese insects VI. Zool. Mag. (Tokyo), 62, 166-169.
- Ishii S. 1914: On four polycystid gregarines from the insects of *Tribolium ferrugineum* F. Ann. Zool. Jap., 8, 435-441.
- Léger L. and Duboscq O. 1904: Nouvelles recherches sur les gregarines et l'épithélium intestinal de Tracheates. Arch. Protistenkd., 4, 335-383.
- Obata K. 1953: Reports on some gregarines from Japanese insects (1). J. Sci. Hiroshima Univ., Ser. B, Div. Zool., 14, 1-34.
- Patil C. C. 1982: Studies on *Protozoa* infecting certain arthropods from North-East Region of Karnataka. Ph. D. Thesis submitted to the Gulbarga University, Gulbarga.
- Théodoridès J. and Jolivet P. 1959: Eugregarines parasites de coleopteres. Explor. Parc. natn. Albert., 8, 95.
- Théodoridès J. and Desportes I. 1966: Quelques gregarines de coleopteres due Laos. Protistologica, 2, 53-58.
- Théodoridès J., Desportes I. and Jolivet P. 1972: Gregarines de la nouvelle-guinee et des îles voisines. Cah. Pac., 16, 110-168.
- Uttangi J. C. and Desai R. N. 1962: On some gregarines from the non-xylophagous termite, *Speculitermes cyclops sinhaensis* from Dharwar (India). J. Anim. Morphol. Physiol., 9, 97-109.
- Watson M. E. 1915: Some new gregarine parasites from arthropods. J. Parasitol., 2, 27-36.
- Watson M. E. 1916: Studies on gregarines including description\* of twenty one new species and a synopsis of the *Eugregarine* records from the *Myriapoda*, *Coleoptera* and *Orthoptera* of the World. Ill. Biol. Monogr., 2, 211-468.
- Zwetkow W. N. 1929: Zur gregarinen-Fauna des Insekten von Peterhof und desscu Umgebungen. Trav. Inst. Scient. Nat. Peterhof, 6, 191-198.



A New Neogregarine Infection of *Prostephanus truncatus* (Horn)  
(Coleoptera, Bostrychidae) Caused by *Mattesia* sp.  
(Ophryocystinae, Neogregarinida)

J. J. LIPA and R. WOHLGEMUTH

Department of Pest and Disease Control, Institute  
of Plant Protection, Miczurina 20, 60-318 Poznań,  
Poland and Institut für Vorratsschutz BBA, Königin  
Luise-Strasse 19, Berlin-Dahlem 33, Berlin West, FRG

Received on 18 June 1985

*Synopsis.* This is the first record of any protozoan infection in the larger grain borer *Prostephanus truncatus* (Horn) and it is caused by an apparently new neogregarine species from the genus *Mattesia*. The infected insects originated from Togo, while the examined colonies originating from Tanzania and Mexico were healthy. The gametocysts of *Mattesia* sp. are ovoid and contain 2 oocysts measuring in water 11.6-14.0 by 6.2-7.8  $\mu\text{m}$  and when fixed and stained with Giemsa's stain — 9.9-13.0 by 6.2-7.4  $\mu\text{m}$ . Infection level ranged from 10 to 38%.

The larger grain borer, *Prostephanus truncatus* (Horn), was accidentally introduced from Central America to Africa (Tanzania, Togo) causing serious losses to stored maize and cassava (Hodges et al. 1983). Information on biology and ecology of this insect is minimal and nothing is known about its natural enemies. Here we report on the first recorded pathogen of *P. truncatus*.

#### Material and Methods

Three strains of *P. truncatus* are maintained in the Institute of Stored Products Protection of the Federal Biological Research Centre for Agricultural and Forestry in Berlin-Dahlem. One, maintained since November 1983, was received from the Tropical Development and Research Institute, Slough, England and originates from specimens collected in October of 1981 in Tanzania (Arusha region). The second strain originates from Togo and was received through the German

Agency for Technical Cooperation Ltd. from Hamburg in January of 1984. The third strain originates from insects collected by one of us (R.W.) in February of 1984 in Togo (surroundings of Lome). All the strains are kept on maize grain at 25°C.

In June and October of 1984, adults pupae and larvae of *P. truncatus* from these colonies were dissected and their tissues were microscopically examined. Smears of infected tissues were prepared, fixed in methanol or in Zenker and then stained with Giemsa's or Heidenhain's hematoxylin.

Additionally, it was also possible to examine in September of 1984 samples from colonies of *P. truncatus* and *Dinoderus* spp. kept at the Tropical Development and Research Institute in Slough, England.

## Results

Infected specimens of *P. truncatus* were first found on 25.VI.1984 in the colony started on 6.III.84 from insects collected in Togo. The infection was also present in the colony started on 30.I.84 from insects also originating from Togo and supplied by GTZ Ltd. The infection level in both samples was 30-36%. Insects in the colony originating from Tanzania were healthy. As can be seen in Table 1, all three colonies kept at the TDRI in Slough and originating from Mexico, Tanzania and Togo were free from infection.

The infection of two Togo strains of *P. truncatus* kept at Berlin-Dahlem was confirmed in October 1984 when more insects were microscopically examined.

Various developmental stages of *P. truncatus* were infected. Although infections were observed in larvae, pupae and adults, the highest infec-

Table 1

Examined laboratory colonies of *Prostephanus truncatus* for *Mattesia* sp. infection

Date of examination and location of colony	Origin of insects and date of starting culture	Number of insects	
		examined	infected
25-30.VI.1984	Tanzania, XI.1983	20	0
Institute of Stored	Togo, 30.I.1984	20	6 (38%)
Products Protection, Berlin (West)	Togo, 6.III.1984	28	10 (36%)
17-19.IX.1984	Mexico, 1976	20	0
Tropical Development and Research	Tanzania, X.1981	24	0
Institute, Slough, Slough Laboratory	Togo, I.1984	20	0
MAFF, Slough			
10-16.X.1984	Togo, 30.I.1984	34	7 (20%)
Institute of Stored Products Protection,	Togo, 6.III.1984	80	8 (10%)
Berlin (West)			



tion level was observed in adult beetles. The low infection level in larvae is probably due to the fact that they develop inside maize grain and have little chance to come in contact with infectious oocysts. On the other hand, adults are active in searching for food, partners to mate and oviposition, and than have a high chance to acquire infection.

The fat body is the primary site of infection but in some heavily infected specimens various stages of the parasite were also seen in the haemocoel.

Various developmental stages of the parasite were observed on smear preparations. The type of schizogony and the formation of gametocytes and oocysts indicate that the parasite belongs to the genus *Mattesia* (*Ophryocystinae*, *Dischizae*, *Neogregarinida*) as defined by Weiser (1955).

The macronuclear meronts are rounded (Pl. I 1) and contain 8-12 nuclei. They turn into gametocytes and then into gametocysts (Pl. I 2). Oocysts (spores) are lemon-shaped (Pl. I 3) and measure in water 11.6-14.0 by 6.2-7.8  $\mu\text{m}$  (mean  $12.63 \times 7.0$ ) and when stained with Giemsa's stain — they measure 9.9-13.0 by 6.2-7.4  $\mu\text{m}$  (mean  $11.78 \times 6.8$ ).

### Discussion

The genus *Mattesia* Naville consists of five species parasitizing insects. Three have been described from beetles:

— *Mattesia trogodermae* Canning (1964) from *Trogoderma granarium* Ev. (*Dermestidae*);

— *Mattesia grandis* McLaughlin (1965) from *Anthonomus grandis* Boh. (*Curculionidae*);

— *Mattesia oryzaephili* Ormieres et al. (1971) from *Oryzaephilus surinamensis* L. (*Cucujidae*).

Two other species are known from *Lepidoptera*:

— *Mattesia dispora* Naville (1930) from *Anagasta kuhniella* (Zell.) and *Plodia interpunctella* (Hbn.) (*Pyralidae*);

— *Mattesia povolnyi* Weiser (1952) from *Homeosoma nebulellum* Hbn. (*Pyralidae*).

The finding of *Mattesia* sp. in *P. truncatus* constitutes the first record of any pathogen from this insect. In addition, neogregarine (schizogregarine) infections have not been previously reported in the family *Bostrychidae* to which *P. truncatus*, the lesser grain borer (*Rhizopertha dominica* F.), *Dinoderus* spp. and others belong. It is, therefore, quite likely that this *Mattesia* is a new species, but it needs to be proven by cross in-

fectivity studies and the comparison of its life cycle with those of previously described species. Such studies are planned in the near future, together with the studies on the possible use of *Mattesia* sp. in the biological control of *P. truncatus*.

#### ACKNOWLEDGEMENT

This research has been partially supported by the USDA and Maria Skłodowska-Curie Foundation grant PL-ARS-89 (J-MOA/USDA-12) to the Institute of Plant Protection in Poznań.

#### REFERENCES

- Canning E. U. 1964: Observations on the life history of *Mattesia trogodermae* sp. n. a schizogregarine parasite of the fat body of the khapra beetle *Trogoderma granarium* Everts. *J. Insect Pathol.*, 4, 305-317.
- Hodges R. J., Dunstan W. R., Magazini I., Golob P. 1983: An outbreak of *Prostephanus truncatus* (Horn) (Coleoptera: Bostrychidae) in East Africa. *Prot. Ecol.*, 5, 183-194.
- Naville A. 1939: Recherches cytologiques sur les schizogregarines. I. Le cycle évolutif de *Mattesia dispora* n.g. n. sp. *Z. Zellforsch. Mikrosk. Anat.*, 11, 375-396.
- McLaughlin R. E. 1965: *Mattesia grandis* n. sp., a sporozoan pathogen of the boll weevil, *Anthonomus grandis* Boheman. *J. Protozool.*, 12, 405-413.
- Ormieres R., Louis C., Kuhl G. 1971: *Mattesia oryzaephili* n. sp., neogregarine parasite d'*Oryzaephilus surinamensis* L. (Coleopt. Cucujidae). Cycle et action pathogène. *Bull. Soc. Zool. Fr.*, 96, 547-556.
- Weiser J. 1952: Cizopasnici housenek ravijice slunecnicoveho *Homeosoma nebulellum*, Hbn., se zvláštím zretelem na druh *Mattesia povolnyi* sp. n. *Zool. Entomol. Listy*, 1, 252-264.
- Weiser J. 1955: A new classification of the schizogregarina. *J. Protozool.*, 2, 6-12.

#### EXPLANATION OF PLATE I

- 1: Macronuclear meront of *Mattesia* sp., 1100×
- 2: Maturing gametocyst, 1100×
- 3: Oocysts (spores) in water mount, 1100×



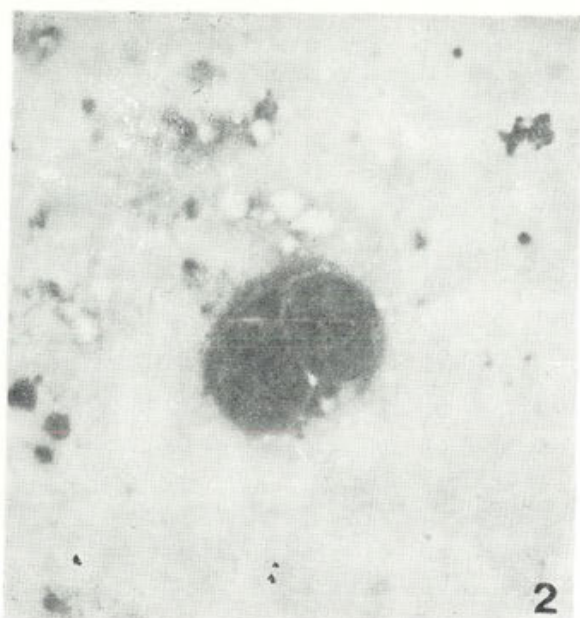

J. J. Lipa et R. Wohlgemuth

auctores phot.





*Leucocytozoon squamatus* sp. n. from Scaly-bellied Green  
Woodpecker, *Picus squamatus squamatus* Vigors

N. C. NANDI

Zoological Survey of India, Sundarbans Field Research Station,  
Canning Town — 743329, 24-Parganas, West Bengal, India

Received on 3 December 1984, revised on 30 August 1985

*Synopsis.* A new species of *Haemosporina*, *Leucocytozoon squamatus* sp. n. from a Scaly-bellied green woodpecker *Picus squamatus squamatus* Vigors from Kashmir State, India is described. It is characterized by round gametocytes (9.6  $\mu\text{m}$  by 9.3  $\mu\text{m}$ ) occurring in a round host cell in which the host cell nucleus forms a thick band circumscribing about one half of the parasite's periphery. A differential diagnosis of the closely related species has been made along with a review of host specificity of leucocytozoid parasites.

A survey of the blood parasites of some birds from Kashmir State (Nandi and Mandal 1978) indicated the presence of a leucocytozoid in one of four Scaly-bellied green woodpeckers, *Picus squamatus squamatus* Vigors. This parasite is herein described as *Leucocytozoon squamatus* sp. n.

#### Material and Methods

Blood smears of 4 Scaly-bellied green woodpeckers, *Picus squamatus squamatus* were drawn immediately after shooting in Kashmir State, India, air-dried, fixed in 100% methanol and stained with a Romanowsky stain. Mensural data were obtained from the camera lucida drawings of the parasites drawn on graph paper (mm division) to facilitate area measurements ( $\mu\text{m}^2$ ) by counting the squares covered. The stage micrometer scale was also drawn on the same graph for necessary linear measurements. Morphometric parameters were measured following Bennett and Campbell (1975). The measurements are expressed in micrometers as means and in parentheses standard deviation values are given.

The Hapantotype slide (Z.S.I. Reg. No. Pt. 2054) will be deposited to the National Zoological Collection, Zoological Survey of India, Calcutta.

## Results

*Leucocytozoon squamatus* sp. n.  
(Fig. 1 A-E, Table 1)

Type host: *Picus squamatus squamatus* Vigors (Family *Picidae*: Order *Piciformes*)

Type locality: Patnitop, Uddampur, Jammu and Kashmir State, India

Immature gametocytes: Gametocytes initiate the development on one side of the erythrocyte which becomes round with broad crescent-shaped host cell nucleus (Fig. 1 E).

Table 1

Morphological parameters of *Leucocytozoon squamatus* sp. n. expressed as means and standard deviation

	Length ( $\mu\text{m}$ )	Width ( $\mu\text{m}$ )	Area ( $\mu\text{m}^2$ )	Index*
Macrogametocyte (N = 15)	9.6 (0.7)	9.3 (0.4)	67.0 (5.6)	1.0
Microgametocyte (N = 10)	9.6 (0.8)	9.0 (0.7)	65.8 (6.4)	0.9
Total complex (females)	12.3 (1.5)	12.1 (0.1)	105.2 (11.7)	1.5
Total complex (males)	11.8 (0.9)	11.0 (0.4)	98.2 (9.8)	1.4
Host cell nuclear distortion (females)	16.3 (2.2)	3.0 (0.5)	32.5 (7.8)	2.9
Host cell nuclear distortion (males)	16.2 (1.8)	3.0 (0.5)	32.4 (6.2)	2.9
Normal erythrocyte (N = 20)	12.0 (0.8)	7.0 (0.8)	67.0 (3.2)	—
Normal erythrocyte nucleus (N = 20)	6.0 (0.5)	2.5 (0.4)	11.0 (1.0)	—

\* Indices were calculated following Bennett et al. 1974

Macrogametocytes: (Fig. 1 A-C, Table 1). N = 15. Typically round parasites measuring 9.6 (0.7) by 9.3 (0.4) and 67.0 (5.6) in area; sometimes oval measuring up to 12.4 by 8.2 and 76.0 in area. Cytoplasm coarse with numerous, scattered, smaller round vacuoles, staining deep blue with Wright's stain. Nucleus usually oval, rarely round, located eccentrically and measuring 3.3 (0.3) by 1.4 (0.3) and 2.8 (0.4) in area. Host cell nucleus uniform and characterized by somewhat thick band-shaped configuration extending nearly 1/2 the parasite's circumference and occupying 16.3 (2.2) by 3.0 (0.5) and 32.5 (7.8) in area. Host cell nuclear index 2.9, parasite index 1.0, and host-parasite index 1.5.



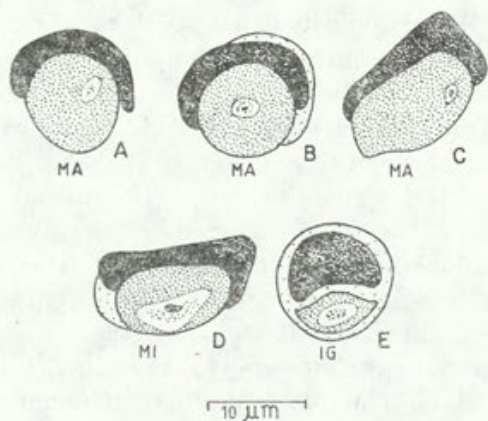

Fig. 1. *Leucocytozoon squamatus* sp. n. in *Picus squamatus squamatus* Vigors. A-C — Macrogametocytes (MA), D — Microgametocyte (MI), E — Immature gametocyte (IG)

Microgametocyte: (Fig. 1 D, Table 1).  $N = 10$ . Usually round but sometimes oval. The almost round microgametocytes measuring 9.6 (0.8) by 9.0 (0.7) and 65.8 (6.4) in area. The morphological peculiarities — generally the same as for macrogametocytes but slightly paler cytoplasm staining with relatively large and diffuse nucleus occupying about 1/3 the parasite's area. Distorted host cell nuclear index 2.9: parasite index 0.9 and host parasite index 1.4.

Normal erythrocyte: As in Table 1.

Schizogony: Unknown

Vectors: Unknown.

### Discussion

*Leucocytozoon squamatus* to some extent resembles *L. fringillinarum*, *L. majoris* and *L. dubreuilii* in gametocyte morphology but differs in the appearance of the parasite-induced distortion of the host cell nucleus. The host cell nucleus of *L. squamatus* forms a thick band about halfway around the parasite's circumference while that of *L. fringillinarum* has a cap-like configuration, that of *L. majoris* is a thin band, one-half to two-thirds about the parasite's circumference and that of *L. dubreuilii* is a thin band connecting two inflated terminal bulbs.

Some 96 species and varieties of *Leucocytozoon* have been described, many on the basis of the "one host-one parasite" philosophy prevalent during the first three decades of this century (Bennett and Laird 1973, Bennett et al. 1982). Experimental evidence, summarized by

Fallis et al. (1974), has indicated that specificity is at the host familial, not host species, level. Currently, a combination of morphological characters and host familial specificity is used for specific diagnosis of this group (Fallis et al. 1974). Bennett and Cameron challenged the validity of this concept when they demonstrated that parasites morphologically consistent with *L. fringillinarum* (Fringillidae), *L. majoris* (Paridae) and *L. dubreuilii* (Turdidae) occurred frequently as double or triple infections in individual birds of the above or different families. However, these three species of *Leucocytozoon* are all parasites of families of the *Passeriformes*. Fallis and Bennett (1966) were unable to transmit various species of *Leucocytozoon* across ordinal lines using sporozoites and natural vectors. Thus, it is unlikely that parasites of the avian order *Passeriformes* would be transmitted to members of the avian order *Piciformes*. Therefore, the parasite under report with its characteristic thick band-like host cell nucleus covering about one half of the parasite's periphery is considered to be a new species. However, if future study shows that leucocytozoid parasites of the *Passeriformes* and *Piciformes* are cross-infective, then *L. squamatus* will fall as a synonym of *L. majoris*.

#### ACKNOWLEDGEMENT

The author is thankful to Dr. B. K. Tikader, Director, Zoological Survey of India, Calcutta for the extended facilities. Thanks are also due to Prof. Gordon F. Bennett, Memorial University of Newfoundland, Canada, and Prof. A. Choudhury, University of Calcutta for their kind interest in this study.

#### REFERENCES

- Bennett G. F. and Campbell A. G. 1975: Avian *Leucocytozoidae*. 1. Morphometric variation in three species of *Leucocytozoon* and some taxonomic implications. *Can. J. Zool.*, 53, 800-812.
- Bennett G. F., Khan R. A. and Campbell A. G. 1974: *Leucocytozoon grusi* sp. n. (*Sporozoa: Leucocytozoidae*) from a sandhill crane, *Grus canadensis* L. *J. Parasitol.*, 60, 359-363.
- Bennett G. F. and Laird M. 1973: Collaborative investigations into avian malarial: an international research programme. *J. Wildl. Dis.*, 9, 26-28.
- Bennett G. F., Whiteway M. and Woodworth-Lynas C. B. 1982: A host parasite catalogue of the avian blood parasites. *Mem. Univ. Nfld. Occas. Pap. Biol.*, 5, 1-243.
- Fallis A. M. and Bennett G. F. 1966: On the epizootiology of infections caused by *Leucocytozoon simondi* in Algonquin Park, Canada. *Can. J. Zool.*, 44, 101-112.
- Fallis A. M., Desser S. S. and Khan R. A. 1974: On species of *Leucocytozoon*. In: *Advances in Parasitology*, (ed. B. Dawes), Academic Press, New York, 12, 1-67.
- Nandi N. C. and Mandal A. K. 1978: Studies on some avian haematozoa from Jammu and Kashmir. *Bull. Zool. Surv. India*, 1, 103-106.



*Paramyxoproteus reinhardti* gen. n. et sp. n. (*Bivalvulida*,  
*Myxospora*), a Parasite of *Reinhardtius hippoglossoides*  
Walbaum, 1792

Jadwiga WIERZBICKA

Institute of Ichthyology, Faculty of Marine Fishery, Agricultural  
Academy, Kazimierza Królewicza 4, 71-550 Szczecin, Poland

Received on 29 June 1985

*Synopsis.* A protozoan parasite *Paramyxoproteus reinhardti* gen. n. et sp. n. from the urinary bladder of the Greenland halibut, *Reinhardtius hippoglossoides*, is described. The fish host originated from the north-west Atlantic off Labrador and the Barents Sea. General prevalence and the intensity of infection of fishes by this parasite is given. In consequence of taxonomic revision, four species hitherto allocated to the genus *Myxoproteus* Doflein, 1898 are transferred to the new genus *Paramyxoproteus*. These are: *P. cordiformis* Davis, 1917, *P. hubbsi* Moser et Noble, 1977, *P. rosenblatti* Moser et Noble, 1977, and *P. moseri* Kovaleva et Gaevskaja, 1982. *Myxoproteus meridionalis* Evdokimova, 1977 is regarded as synonymous with *Conispora renalis* Sankurathri, 1977.

Protozoans of the genus *Myxoproteus* Doflein, 1898, occur in marine fishes, most frequently in the urinary bladder, sometimes in the gall bladder. According to the data in the literature, this genus comprises of 17 species. Among them, generic status of *M. myxocephali* described by Fantham et al. (1940), is being considered doubtful by Sankurathri (1977), Kovaleva and Gaevskaja (1979), and by the present authoress<sup>1</sup>.

In the Atlantic as many as 10 species of *Myxoproteus* were recorded as yet. These are: *M. formosus* and *M. scoleciformis* from the Celtic Sea (Kovaleva and Gaevskaja 1979), *M. ambiguus* off the west coast

<sup>1</sup> It is recommended, to put this species, *Myxoproteus myxocephali* Fantham et al. (1940) on the list of "genera incertae sedis" for further taxonomic examination.

of France and from the Mediterranean Sea (cf. K u d o 1919), *M. cordiformis* and *M. cornutus* off the south-east coast of USA (cf. K u d o 1919), *M. hubbsi* off the northern coast of South America (M o s e r and N o b l e 1977), *M. biliaris*, *M. innae*, and *M. meridionalis* from south-west Atlantic (E v d o k i m o v a 1977), and *M. moseri* from the same area (K o v a l e v a and G a e v s k a j a 1982). In the Pacific only 4 species were described, namely: *M. inexpectatus* from the Sea of Japan (Š u l m a n 1966), *M. californicus*, and *M. abyssus* off the coast of California (Y o s h i n o and N o b l e 1973, Y o s h i n o and M o s e r 1974), and *M. rosenblatti* off the coast of America (M o s e r and N o b l e 1977). Moreover, Š u l m a n (1953, 1966) described two species, *M. caudatus* and *M. elongatus*, from the White Sea and the Barents Sea, and Z u b c h e n k o (1980) noted the occurrence of *Myxoproteus* sp. among others in *Reinhardtius hippoglossoides* from north-west Atlantic.

S a n k u r a t h r i (1977) had found a myxosporidian with sinuous suture line of the spore in the nephridian tubules of *Merluccius productus*, and basing on this character, described a new genus *Conispora* with the type species *C. renalis*. S a n k u r a t h r i added to this genus also *M. abyssus* Yoshino et Moser, 1974.

The myxosporidians found in *Reinhardtius hippoglossoides* by the authoress of this paper differ from any other species of *Myxoproteus* described so far. Moreover, some features of the spores do not fit the generic diagnosis as given by Š u l m a n (1966). The observed differences have inclined the author to suggest the new genus and new species for them. The name *Paramyxoproteus reinhardti* gen. n. et sp. n. is proposed. The distinction of the genus *Conispora* Sankurathri, 1977 and of *Paramyxoproteus* gen. n. give the basis for the revision of the species hitherto allocated to the genus *Myxoproteus*.

### Material and Methods

The material originated from north-west Atlantic and the Barents Sea. Samples of fishes from Labrador fishing grounds (53°20' N, 52°20' W) were taken on June 26, 1976, and those from the Barents Sea (72°34' N, 15°00' E) on May 6, 1977. The fishes were sent to the laboratory in a frozen condition.

After defreezing the material, scrapings were taken from the urinary bladder of each fish, and examined under the microscope. The content of the gall bladders was surveyed too. Totally, 261 *R. hippoglossoides* were examined, out of this number 155 specimens were originated from the Labrador fishing ground and 106 from the Barents Sea. Total length of these fishes ranged from 24.2 to 77.5 cm and body weight from 75 to 5140 g. In cases of heavy infection some pieces of the urinary bladder wall or scrapings were fixed in 5 per cent for-



malin for further examination. The drawings were made on not fixed material. The measurements were taken from 20 not fixed spores (from two fishes from the Barents Sea) as well as from 50 spores fixed in 5 per cent formalin (this number consists of 24 spores from one fish from the Barents Sea and 26 spores from two fishes off Labrador).

## Results

### *Paramyxoproteus* gen. n.

The spores are inversely pyramidal in shape, most often flattened at the anterior pole. Some spores show lateral extensions of valves, that differ in size and shape. The suture is straight, oblique to the longitudinal axis of the spore (viewed from suture side). Two spherical polar capsules lie in the anterior part of the spore, in suture plane (slight deviations are possible). Vegetative stages — plasmodia. These parasites occur in the urinary system and gall bladder of marine fishes.

Typical species: *Paramyxoproteus reinhardti* sp. n.

### *Paramyxoproteus reinhardti* sp. n.

Host: Greenland halibut, *Reinhardtius hippoglossoides* Walbaum, 1792.

Location: urinary bladder.

Locality: north-west Atlantic off Labrador, and the Barents Sea.

Infection: The parasite was frequently noted in the examined fishes — prevalence of infection was 84.7%. Intensity ranged from singular to very numerous spores. Sometimes even mass infection was observed.

Shape of spores is close to elipsoidal (from suture side), with sharpened posterior and slightly flattened or rounded anterior end (Fig. 1). At sides the spore has wide, triangular wing-like widenings. Single, fairly large, oval nucleus occur in the middle part of each widening. The suture line is rather clearly marked and straight. It runs through the spore in the diagonal plane, from the pointed posterior pole to the anterior one, in front of the polar capsules (Fig. 1, 2, 3). Two fairly big, spherical polar capsules lie closely to each other in the suture plane near the anterior edge of the spore. Sometimes the capsules adjoin each other. Inside them 5-7 coils of the polar filament can be seen. The outlets of the polar capsules lie at the anterior edge, at opposite sides of the spore (Fig. 3). Curved, clearly visible nuclei of the polar capsules, lie directly under the polar capsules. The sporoplasm of the embryo, feebly visible, occupies the middle and posterior part of the spore.

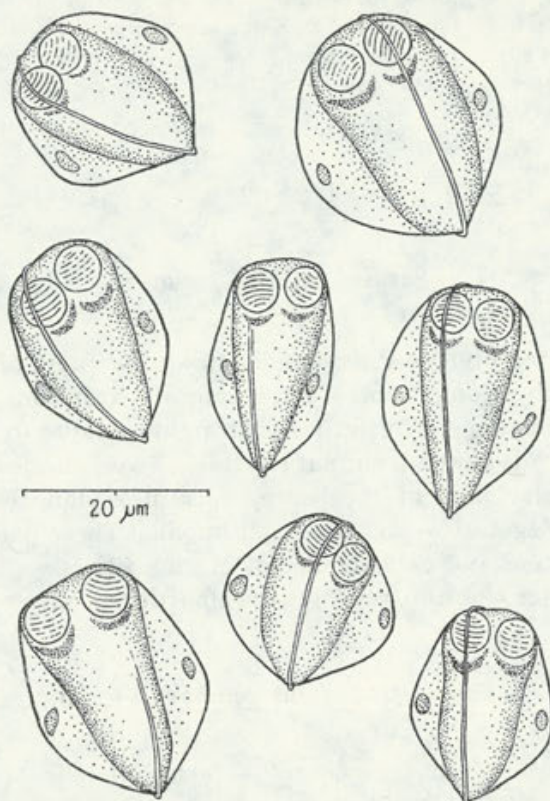

Fig. 1. Spores of *Paramyxoproteus reinhardtii* gen. n., sp. n. (viewed from suture line)

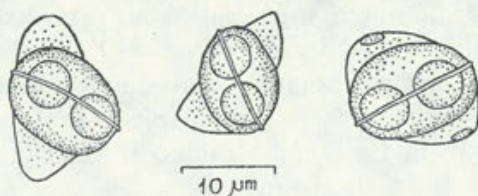

Fig. 2. Spores of *Paramyxoproteus reinhardtii* gen. n., sp. n. (apical view, slightly slanting)

Dimensions of spores (in  $\mu\text{m}$ ): length of not fixed spores 20.0-28.0 ( $25.18 \pm 2.18$ )<sup>2</sup>, width including lateral extensions 17.2-25.2 ( $20.12 \pm 1.79$ ), polar capsule diameter 4.4-5.6 ( $4.84 \pm 0.30$ ). Dimensions of spores fixed in formaline: length 20.0-24.4 ( $22.29 \pm 1.15$ ), width 15.6-20.0 ( $17.54 \pm 1.40$ ),

<sup>2</sup> Arithmetical mean of the sample and standard deviation.



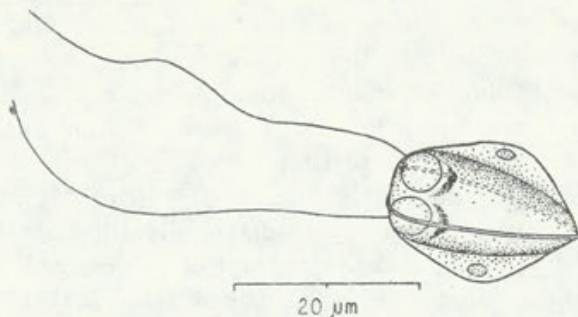

Fig. 3. Spore of *Paramyxoproteus reinhardti* gen. n., sp. n. with extruded filaments (scheme)

polar capsule diameter 4.0-4.8 ( $4.53 \pm 0.23$ ). Thickness of spores, difficult to measure due to lateral extensions, is about 11-12  $\mu\text{m}$ . During the whole time of observation only two spores with extruded polar filaments were found. The filaments measured about 45  $\mu\text{m}$  in one spore, and about 50  $\mu\text{m}$  in the other.

As the investigation was made on frozen material, the vegetative stages were difficult to identify.

### Discussion

The new genus *Paramyxoproteus* morphologically closely resembles the genera *Myxoproteus* Doflein, 1898, *Conispora* Sankurathri, 1977, *Bipteria* Kovaleva, Zubčenko et Krasin, 1983, and *Schulmania* Kovaleva, Zubčenko et Krasin, 1983. In all of them, the spores are inversely pyramidal or pear-like in shape, with two spherical polar capsules in the anterior part. Essential differences between these genera concern the suture line and the situation of polar capsules in relation to the suture plane. The genera *Conispora* and *Bipteria* are characterized by a sinuous suture line in contrast to a straight one in *Myxoproteus* and *Paramyxoproteus*, and a straight or waving one in *Schulmania*. *Bipteria* spores possess two big wing-like extensions which are not present in the spores of *Conispora*. In both genera, *Myxoproteus* (cf. Šulman 1966) and *Schulmania* (cf. Kovaleva et al. 1983), the suture line runs perpendicularly to the polar capsule plane, while in *Paramyxoproteus* gen. n. it is diagonal to the longitudinal axis of the spore and polar capsules lie in the plane marked by the suture line. Moreover, *Paramyxoproteus* has no keel-like membrane running along the suture line, which is distinguishing character for the genus *Schulmania*. The suture line direction in the spore and situation of polar capsules in relation to suture plane are regard-

ed as important generic characters in taxonomy of *Myxospora* group. Taking into consideration that these characters in the examined material from the urinary bladder of *Reinhardtius hippoglossoides* are completely different from the data given in the literature, creation of the new genus, *Paramyxoproteus*, seems to be justifiable.

Out of 16 species allocated so far to the genus *Myxoproteus*, four species show the suture line running diagonally through the spore from the middle of the posterior end to the front of polar capsules. Such course of the suture line is known in: *M. cordiformis* Davis, 1917 from the urinary bladder of *Chaetodipterus faber*; *M. hubbsi* Moser et Noble, 1977 from the gall bladder of *Coelorhynchus coelorhynchus carminatus*; *M. rosenblatti* Moser et Noble, 1977 from the gall bladder of *Coryphaenoides acrolepis* and *C. filifer*, as well as from the urinary bladder and kidney of *C. ariommus* and *C. armatus*; and *M. moseri* Kovaleva et Gaevskaja, 1982 from the urinary bladder of *Salilota australis* and *Coelorhynchus fasciatus*. As the suture plane in all the species mentioned above is the same as the one described in *Paramyxoproteus* gen. n., it is recommended to transfer these species to the new genus. So, the genus *Paramyxoproteus* would comprise the following species: *P. reinhardti* sp. n., *P. cordiformis* Davis, 1917, *P. hubbsi* Moser et Noble, 1977, *P. rosenblatti* Moser et Noble, 1977, and *P. moseri* Kovaleva et Gaevskaja, 1982.

The myxosporidians found in *Reinhardtius hippoglossoides* clearly differ from all the species included in this genus. *P. hubbsi* and *P. rosenblatti* have no lateral extensions, which are present in *P. reinhardti* sp. n. Moreover, *P. hubbsi* spores are about three times smaller (Moser and Noble 1977). Due to alate extensions the new species mostly resembles *P. cordiformis*, but differs from the latter by its shape and dimensions of spores (cf. Kudo 1919). The spores of *P. cordiformis* are about twice as small as the ones in the present material from *R. hippoglossoides*. In the description of *P. moseri* Kovaleva and Gaevskaja (1982) mentioned that the spores had thickened walls. However, the drawings clearly show that these thickenings differ in shape from alate extensions of spores in *P. reinhardti* sp. n. Moreover, in contrast to the new species, the spores of *P. moseri* are much more round in shape (viewed from the suture side) with polar capsules distant from each other. Polar capsules of *P. moseri* are also smaller, measuring 2.2-3.3  $\mu\text{m}$  only, while those of *P. reinhardti* measure 4.0-4.8  $\mu\text{m}$  (in not fixed spores — even up to 5.6  $\mu\text{m}$ ).

From the urinary bladder of the same host, *R. hippoglossoides*, and from another right-eye flounder, *Atheresthes evermanni*, Russian authors (Kovaleva et al. 1983) have described a new species, *Schulmania quadrilobata*. Spores of their species are characterized by the collo-



cation of the polar capsules which are placed in the perpendicular line to suture plane, and by the thin transparent membrane which runs along the suture in the mid-line of the spore. *Paramyxoproteus reinhardtii* sp. n. is clearly distinguished from *S. quadrilobata* by the direction of the suture line which runs diagonally through the spore, and having no membrane, as well as with another position of the polar capsules.

Creation of the genus *Conispora* by Sankurathri (1977) on the base of sinuous suture line seems to be justifiable. Within this genus Sankurathri (1977) placed *Myxoproteus abyssus* Yoshino et Moser, 1974. According to the first description by Evdokimova (1977), and the redescription by Kovaleva and Gaevskaja (1982), *M. meridionalis* from the urinary bladder of *Merluccius hubbsi* having sinuous suture line shows close affinity with *C. renalis* Sankurathri, 1977 from nephridial tubules of *Merluccius productus*. Also some other features, including spore dimensions and shape, show great similarity. Thus, it is concluded that these species are conspecific. As the paper by Sankurathri (1977) was accepted for publication on 22nd December 1976 while the paper by Evdokimova has no such date, the priority has to be given to Sankurathri's name. Thus, *M. meridionalis* Evdokimova, 1977 should be considered as a synonym of *C. renalis* Sankurathri, 1977.

What concerns other representatives of the genus *Myxoproteus*, the suture line course in *M. biliaris* Evdokimova, 1977 and in *M. californicus* Yoshino et Noble, 1973 ought to be reexamined. As for the first one Evdokimova (1977) noted that the suture line was curved. As far as the second one is concerned, no clear information on the course of the suture has been given, what has already been pointed out by Sankurathri (1977). Besides, there are two more species of the genus *Myxoproteus*, in which the suture line has not been described at all. These are: *M. ambiguus* Thélohan, 1895 and *M. inexpectatus* Schulman, 1966. As nothing can be said about their proper generic assignment on the basis of the existing data, they must be left in the genus *Myxoproteus*.

#### REFERENCES

- Evdokimova E. B. 1977: Mikosporidii kostistyh ryb Patagonskogo šelfa (Atlantičeskoe pobereže Argentiny). *Parazitologija*, 11, 166-178.
- Fantham H. B., Porter A. and Richardson L. R. 1940: Some more *Myxosporidia* observed in Canadian fishes. *Parasitology*, 32, 333-353.
- Kovaleva A. A. and Gaevskaja A. V. 1979: Dva novyh vida mikosporidij roda *Myxoproteus* ot ryb Keltskogo Morja. *Parazitologija*, 13, 437-439.
- Kovaleva A. A. and Gaevskaja A. V. 1982: Novye vidy mikosporidij ryb jugo-zapadnoj Atlantiki. *Parazitologija*, 16, 353-359.
- Kovaleva A. A., Zubčenko A. V. and Krasin V. K. 1983: Obosnovanie novogo semejstva mikosporidij (*Protozoa, Myxosporidia*) s opisaniem dvuh novyh rodov. *Parazitologija*, 17, 195-202.

- Kudo R. 1919: Studies on *Myxosporidia*. A synopsis of genera and species of *Myxosporidia*. Ill. Biol. Monogr., 5, 245-503.
- Moser M. and Noble E. R. 1977: The genus *Myxoproteus* (Protozoa: *Myxosporida*) in macrourid fishes. Intern. J. Parasitol., 7, 253-255.
- Sankurathri C. S. 1977: *Conispora renalis* gen. nov. et sp. nov. (*Myxosporida*: *Wardiidae*) from the kidney tubules of Pacific hake, *Merluccius productus* Ayres, 1855, in coastal waters of British Columbia. Canad. J. Zool., 55, 1147-1150.
- Šulman S. S. 1953: Novye i maloizučennye slizistye sporoviki Belogo Morja. Zool. Žurn., 32, 384-393.
- Šulman S. S. 1966: Miksosporeidii fauny SSSR. Izd. "Nauka", Moskva—Leningrad.
- Yoshino T. P. and Moser M. 1974: *Myxosporida* (Protozoa) in macrourid fishes (*Coryphaenoides* spp.) of the northeastern Pacific. J. Parasitol., 60, 655-659.
- Yoshino T. P. and Noble E. R. 1973: *Myxosporida* of macrourid fishes from southern California and Mexico. J. Parasitol., 59, 844-850.
- Zubchenko A. V. 1980: Parasitic fauna of *Anarhichadidae* and *Pleuronectidae* families of fish in the northwest Atlantic. Intern. Commis. Northwest Atlant. Fish., Selec. Pap., 6, 41-46.



On Two New Species of *Myxobolus* Butschli, 1882  
(*Myxozoa: Myxosporea*) from the Fresh Water Fishes of West  
Bengal, India

N. K. SARKAR

Department of Zoology, Rishi Bankim Chandra College, Naihati 743165,  
West Bengal, India

Received on 24 November 1984

*Synopsis.* The two new myxosporidians (*Myxozoa: Myxosporea*) *Myxobolus mystusius* sp. n. obtained from the gill filament and *M. mahendrae* sp. n. obtained from the gill arch epithelium of two fresh water teleost *Mystus vittatus* Day and *Catla catla* (Ham.) respectively, from West Bengal, India are described. The characteristic spore dimensions of *M. mystusius* sp. n. are  $13.18\ \mu\text{m} \times 9.39\ \mu\text{m} \times 7.33\ \mu\text{m}$  and that of *M. mahendrae* sp. n. are  $12.7\ \mu\text{m} \times 10.37\ \mu\text{m}$ .

In the course of a detailed survey of the myxosporidians parasitizing the fresh water fishes of West Bengal, India, two new species of *Myxobolus* Butschli, 1882 have been recovered from the gills of two fresh water fishes *Mystus vittatus* Day and *Catla catla* (Ham.) during the period of May, 1983 to September, 1984.

#### Material and Methods

The parasites were recovered from the gills of fresh water fishes collected from the fishermen of Chinsurah, West Bengal and the smears of the parasites were prepared. Some of the smears were treated with Lugol's iodine solution to study the spores in fresh condition and also to detect the iodophilus vacuole. The other smears were stained with Giemsa after fixation in absolute Methanol. A few smears were treated with 5% KOH solution for the extrusion of the polar filament. The measurements of the fresh spores are taken in micrometers ( $\mu\text{m}$ ). The Figures were drawn with the aid of a camera lucida (Prism type).

## Observations

*Myxobolus mystusius* sp. n.

## Description

The cyst and other vegetative forms were not found. The spores were histozoic, almost lenticular with straight thin suture in sutural view (Fig. 1 1) and broadly pyriform with rounded posterior and sharply-pointed anterior tip in valvular view (Fig. 1 2). The shell valves were two — symmetrical, smooth and thin-walled. The two polar capsules were convergent, unequal in size and shape — broadly pyriform larger polar capsule with 8-9 coils of polar filament and narrowly pyriform smaller polar capsule with 3-4 coils. No intercapsular ridge was present. Only the filament of the large polar capsule was extruded and measured about 16.0  $\mu\text{m}$  to 20.0  $\mu\text{m}$  long (Fig. 1 3). It was ribbon-like. The large extracapsular space was filled with finely granular mass of sporoplasm containing a small iodophilus vacuole and one to two nuclei (Fig. 1 1-3).

**M e a s u r e m e n t s** (mean value of 20 fresh spores with range within the parenthesis is given):

Length of the spore — 13.18 (12.22-13.96)

Breadth of the spore — 9.39 (8.73-10.47)

Thickness of the spore — 7.33 (6.98-7.68)

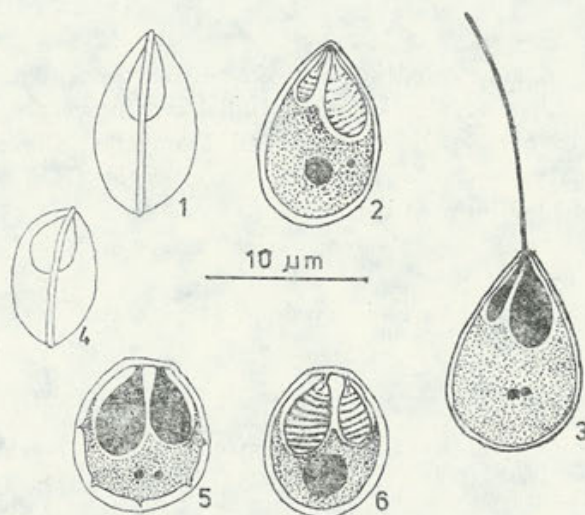

Fig. 1. 1-3 — Spore of *Myxobolus mystusius* sp. n. 1 — A fresh spore in sutural view, 2 — A fresh spore in valvular view showing iodophilus vacuole — Lugol's iodine, 3 — A spore in valvular view showing extruded ribbon-like filament of the large polar capsule — Giemsa. 4-6 — Spore of *Myxobolus mahendrae* sp. n. 4 — A fresh spore in sutural view, 5 — A spore in valvular view — Giemsa, 6 — A fresh spore in valvular view showing iodophilus vacuole — Lugol's iodine



Length of polar capsule (large) — 7.12 (6.28-7.68)

Breadth of polar capsule (large) — 3.59 (2.79-4.19)

Length of polar capsule (small) — 4.05 (3.49-4.19)

Breadth of polar capsule (small) — 1.33 (1.40-1.75)

Diameter of the iodophilus vacuole — 3.00

Infection locus: Gill filaments

Incidence: Two infected (5-6 mm in length) out of 15 fishes examined

Pathogenicity: Not apparent

Host: *Mystus vittatus* Day

Locality: Chinsurah, West Bengal, India

**Remark:** The present myxosporidan with polar capsules unequal in size and shape, resembles *Myxobolus calbasui* Chakravarty, 1939 reported from the gall-bladder of *Labeo calbasu* (Ham.), *L. rohita* (Ham.) and *Cirrhina mrigala* (Ham.); *M. mrigalae* Chakravarty, 1939 from the scales of *Cirrhina mrigala* (Ham.); *M. bhadrensis* Seenappa and Manohar, 1981 from the muscles of *Labeo rohita* (Ham.); *M. hosadurgensis* Seenappa and Manohar, 1981 and *M. vedavatiensis* Seenappa and Manohar, 1981 from the gills, muscles and gills of *Cirrhina mrigala* (Ham.) respectively. The former species, however, differs from all the latter species by the larger dimensions of its spore. Further, the myxosporidan in study, has closer dimensions of spore with *M. clarii* Chakravarty, 1943 reported from the gall-bladder, liver, testis, fat-bodies of *Clarius batrachus* and *M. barbi* Tripathi, 1951 from the skin of *Barbus ticto* (Ham.) but differs from them by its unequal polar capsules, pointed anterior end and shorter, ribbon-like polar filament. The myxosporidan is, therefore, considered to be a new species for which the name *Myxobolus mystusius* sp. n. is proposed after the name of the host.

*Myxobolus mahendrae* sp. n.

**Description**

The cyst and other vegetative stages were not seen. The spores were histozoic, almost cylindrobiconical with thin, slightly curved suture in sutural view (Fig. 1 4) and ovoidal with truncate anterior end in valvular view (Fig. 1 5). The shell valves were two, symmetrical, smooth and thick-walled with 5 to 6 triangular markings on the wall. The polar capsules were broadly pyriform, unequal, slightly convergent, open side by side but never crossed. The larger polar capsule had 8 to 9 coils while the smaller polar capsule had 5 to 6 coils of polar filament. The intercapsular ridge was absent. The extracapsular space was filled with granular sporoplasm containing two nuclei and a centrally placed large iodophilus vacuole (Fig. 1 5, 6).

**Measurements** (mean value of 20 fresh spores with range within the parenthesis is given):

Length of the spore — 12.70 (11.52-13.96)

Breadth of the spore — 10.37 (9.77-10.47)

Length of the polar capsule (large) — 6.98 (6.28-7.33)

Breadth of the polar capsule (large) — 3.73 (3.49-4.19)

Length of the polar capsule (small) — 5.44 (4.19-6.98)

Breadth of the polar capsule (small) — 3.42 (3.14-3.49)

Diameter of iodophilus vacuole — 4.54

Infection locus: Gill arch epithelium

Incidence: Two infected out of 5 fishes examined (all were just more than 1 kg in weight)

Pathogenicity: Not apparent

Host: *Catla catla* (Ham.)

Locality: Chinsurah, West Bengal, India

**Remark:** Only two myxosporidians *Myxobolus catlae* Chakravarty, 1943 and *M. bengalensis* Chakravarty and Basu, 1948 have been reported from the branchiae of *Catla catla* (Ham.). The present species differs from *M. catlae* by its unequal pair of broadly pyriform polar capsules (equal and pyriform polar capsules in *M. catlae*). It also differs from *M. bengalensis* by its larger dimensions of spore (spore dimensions of *M. bengalensis* are  $8.56-9.36 \times 6.42-6.80$ ) and its truncated anterior end. Moreover, it is also comparable with *M. vedavatiensis* Seenappa and Manohar, 1981 since both have ovoidal spore. However, the myxosporidan in study is different from the latter species by its anteriorly truncated spore (anteriorly round spore in *M. vedavatiensis*) and by the absence of intercapsular process (presence of large intercapsular process in *M. vedavatiensis*). The present species also resembles *M. basilamellaris* Lom and Molnar, 1983 reported from the gills of *Cyprinus carpio* L. in having thick-walled shell valve with triangular markings, broadly pyriform spore and unequal pair of polar capsule but differs from the latter by the larger dimensions of the spore and polar capsules (dimensions of spore and polar capsules of *M. basilamellaris* are  $7.3-9.9 \times 7.7-12.2$  and  $2.2-3.3 \times 3.2-5.4$  and  $1.8-3.3 \times 2.5-4.4$  respectively). The present myxosporidan is, therefore, a distinct species and the name *Myxobolus mahendrae* sp. n. is proposed after my father Late Mahendra nath Sarkar.

Syntypes material of *Myxobolus mystusius* sp. n. and *M. mahendrae* sp. n. on slides no. MXM-8 and MXM-12 respectively are kept in the author's collection and will be deposited soon to the Zoological Survey of India, Calcutta.

#### ACKNOWLEDGEMENTS

I am indebted to the Principal and the Head of the Department of Zoology, R.B.C. College, Naihati for laboratory facilities and also to U.G.C. New Delhi for financial assistance.



## REFERENCES

- Chakravarty M. 1939: Studies on *Myxosporidia* from the fishes of Bengal, with a note on the myxosporidian infection in aquaria fishes. Arch. Protistenk., 92, 169-178.
- Chakravarty M. 1943: Studies on *Myxosporidia* from the common food fishes of Bengal. Proc. Indian Acad. Sci., 18 B, 21-35.
- Chakravarty M. and Basu S. P. 1948: Observations on some myxosporidians parasitic in fishes with an account of nuclear cycles in one of them. Proc. Zool. Soc. Bengal, 1, 23-33.
- Lom J. and Molnar K. 1983: *Myxobolus basilamellaris* sp. n. (Myxozoa: Myxosporea), a parasite of the gills of common carp (*Cyprinus carpio* L.). Folia Parasitol., 30, 1-3.
- Seenappa D. and Manohar L. 1981: Five new species of *Myxobolus* (Myxozoa: Protozoa), parasitic in *Cirrhina mrigala* (Hamilton) and *Labeo rohita* (Hamilton), with a note on a new host record for *M. curmucae* Seenappa and Manchar, 1980. J. Protozool., 28, 358-360.
- Tripathi Y. R. 1951: Studies on parasites of Indian fishes. I. Protozoa, *Myxosporidia*, together with a check list of parasitic protozoa described from Indian fishes. Rec. Indian Mus. (Calcutta), 50, 63-88.





## NOTICE TO AUTHORS

ACTA PROTOZOOLOGICA is intended as a journal serving for the publication of original papers embodying the results of experimental or theoretical research in all fields of protozoology with the exception of faunistic notices of the local character and purely clinical reports. The papers should be concise and will not be accepted if they have been previously published elsewhere. After acceptance by the Editors papers will be printed in the possibly shortest time.

Papers are accepted in English, French, German and Russian. Every paper should begin with the name and postal address of the laboratory, name and the surname of the author and title in the language of the text. The titles in German and French should be translated into English according to the demands of Current Contents. The paper should be accompanied by synopsis in the language of the text not exceeding 100 words and by short summary in one of 4 languages accepted in the Journal. In the Russian text also the name and the postal address of the laboratory, legends of tables, plates and text illustrations must be translated, the translation of the summary may be somewhat more extensive, and the name of the author should be given additionally also in the Latin characters.

Manuscripts should be doublespaced typescript (30 lines on side of a sheet) with a normal margin. No elements of the text should be fully typed in capitals nor in spaced set (only underlining with pencil is admissible). In decimal fractions points not commas should be used. The generally accepted abbreviations and symbols are recommended. Nomenclature must agree with the International Code of Zoological Nomenclature, London 1961. The original and one carbon copy of the whole text material should be supplied.

References must be cited in the text indicating only the author and year thus: "Kinosita (1954) found that, etc."

Only all references cited in the text should be listed. The list must be arranged as follows:

Ehret C. F. and Powers, E. L. 1959: The cell surface of *Paramecium*. Int. Rev. Cytol., 8, 97-133.

Gelei J. von 1939: Das aussere Stützgerüstsystem des *Paramecium*körpers. Arch. Protistenk., 92, 245-272.

Titles of references are given in their original language (not translated). In papers written in English, French or German, the Cyrillic type of the Russian is transliterated according to the international system (ISO Recommendation R 9 September). This regulation is not applied to names if there exists in their traditional spelling. Also author may freely choose in transliteration of his own name. In Russian papers, the Russian references are cited in Cyrillic, the others in the Latin characters, but they must be listed all together in the Latin alphabetical order.

The following material should be supplied on separate sheets: (1) the running title for the page headlines, (2) tables, (3) legends for text figures, (4) legends for plates. Line-drawings will be published in the text, photographs and raster figures on separate plates. No coloured photographs can be published presently. Lettering on photographs and drawings should be marked in pencil. With no regard to the language of the text, only the Latin lettering, arabic numerals or generally accepted symbols are admissible for marking on illustrations. Numbering of text-figures, plates and tables must be also marked in pencil, as well in the legends as in the text.

Galley proofs are sent to the authors. Authors receive 75 reprints without covers.





## In preparation:

I. Wita and K. M. Sukhanova: Seasonal Modifications in the Life Cycle of *Parastasia jennica* (Michajłow, 1966) — D. Chardez: Thécamoebiens des plages de la Mer du Nord en Angleterre — N. Wilbert: Ciliaten aus dem Interstitial des Ontario Sees — R. Mathur and D. M. Saxena: Inhibition of Macromolecule Syntheses in a Ciliate Protozoan, *Tetrahymena pyriformis* by Hexachlorocyclohexane (HCH) Isomers — W. Kasprzak, T. Mazur and E. Hadaś: Biochemical Changes of *Acanthamoeba* Following Attenuation and the Role of Cysts in Retaining the Characteristics of Strains — T. Michałowski, P. Szczepkowski and P. Muszyński: The Nutritive Factors Affecting the Growth of the Rumen Ciliate *Diploplastron affine* *in vitro* — A. Czapik et N. Wilbert: Sur une nouvelle espèce de cilié *Paranophrys carnivora* sp. n. (Scuticociliatida) — S. L. Kazubski and S. A. M. El-Tautawy: A Ciliate *Paratrichodina africana* sp. n. (*Peritricha*, *Trichodinidae*) from *Tilapia* Fish (*Cichlidae*) from Africa — S. A. M. El-Tantawy and S. L. Kazubski: The Trichodinid Ciliates from Fish *Tilapia nilotica* from the Delta of Nile (Egypt) — S. L. Kazubski: The Trichodinid Ciliates from Fish *Tilapia* sp. from Victoria Lake (Kenya) and Description of *Trichodina equatorialis* nom. nov. — C. K. Sinha: Occurrence of *Trypanosoma mukasai* Hoare, 1932 in *Tilapia mossambica* (Peters) from India — S. Ghose, S. K. Ray and D. P. Haldar: *Neohirmocystidae* fam. n., a New Family of Septate Gregarines (*Apicomplexa: Sporozoa*) from Insects — V. N. Hoogar and S. D. Amoji: *Leidyana bimaculata* a New Cephaline Gregarine Parasite of a Cricket, *Gryllus bimaculatus* De Geer — C. K. Sinha: *Hepatozoon mucosus* sp. n. from Indian Rat Snakes, *Ptyas mucocis* (Linnaeus) — N. K. Sarkar: A New Myxosporidan *Myxidium sciaenae* sp. n. (*Myxozoa: Myxidiidae*) from the Gall Bladder of a Marine Teleost of West Bengal, India

## Warunki prenumeraty

Cena prenumeraty krajowej: rocznie 560 zł, półrocznie 280 zł

Terminy przyjmowania prenumerat na kraj i za granicę:

— do dnia 10 listopada na I półroczu roku następnego i na cały rok następny,

— do dnia 1 czerwca na II półroczu roku bieżącego.

Prenumeratę na kraj przyjmują i informacji udzielają urzędy pocztowe i doręzyciele na wsi oraz Oddziały RSW „Prasa-Książka-Ruch” w miastach.

Prenumeratę ze zleceniem wysyłki za granicę przyjmuje RSW „Prasa-Książka-Ruch”, Centrala Kolportażu Prasy i Wydawnictw, ul. Towarowa 28, 00-958 Warszawa, konto NBP XV Oddział w Warszawie Nr 1153-201045-139-11.

Wysyłka za granicę pocztą zwykłą jest droższa od prenumeraty krajowej o 50% dla zlecających indywidualnych i o 100% dla zlecających instytucji i zakładów pracy.

Bieżące i archiwalne numery można nabyć lub zamówić we Wzorcowni Ośrodka Rozpowszechniania Wydawnictw Naukowych PAN, Pałac Kultury i Nauki, 00-901 Warszawa.

## CONTENTS

S. Serrano, M. T. Fernandez-Galiano and D. Fernandez-Galiano: Morphology of the Anterior Fibrillar System in Two Species of the Genus <i>Entodinium</i> ( <i>Ciliophora</i> , <i>Entodiniomorpha</i> ), and its Formation during the Bipartition Process . . . . .	133
M. Wolska: <i>Pseudoentodinium elephantis</i> gen. nov., sp. n. from the Order <i>Entodiniomorpha</i> . Proposition of the New Family <i>Pseudoentodiniidae</i> . . . . .	139
D. C. Lennartz: A Preliminary Study of Induction of Macrostomal Development in <i>Tetrahymena vorax</i> , V <sub>2</sub> S Treated with d-Alpha-Tocopheryl Succinate . . . . .	147
A. Grębecki: Recovery of Cytoskeletal and Motor Capacities by the Hyaline Blebs Produced by <i>Amoeba proteus</i> . . . . .	153
E. Wyroba: Effect of $\beta$ -Receptor Antagonist Dichloroisoproterenol on <i>Paramecium</i> Endocytosis . . . . .	167
R. Swydan, Z. Darvas and G. Csaba: Stimulation of Phagocytosis by Diazepam in Several Subsequent Generations of the <i>Tetrahymena</i> . . . . .	175
E. Mikołajczyk, W. Nultsch and D.-P. Häder: Chemoaccumulations of the Colorless Flagellate, <i>Astasia longa</i> , in the Presence of the Photosensitizer Methylene Blue . . . . .	179
W. Lueken and B. Oelgemöller: Graded Morphogenetic Response to Preparing Cell-Cell Interactions in <i>Euplotes vannus</i> . . . . .	187
G. Fernandez-Leborans and M. T. Antonio-Garcia: Interaction Lead-Zinc in a Natural Community of Protozoans . . . . .	195
C. C. Patil and S. D. Amoji: Eugregarine Parasites of <i>Coleoptera</i> from North-East Region of Karnataka. IV. <i>Steinina rodgii</i> sp. n., Found in the Gut of <i>Scleron reitteri</i> Gb. . . . .	213
J. J. Lipa and R. Wohlgenuth: A New Neogregarine Infection of <i>Prostephanus truncatus</i> (Horn) ( <i>Coleoptera</i> , <i>Bostrychidae</i> ) caused by <i>Matessia</i> sp. ( <i>Ophryocystinae</i> , <i>Neogregarinida</i> ) . . . . .	219
N. C. Nandi: <i>Leucocytozoon squamatus</i> sp. n. from Scaly-bellied Green Woodpecker, <i>Picus squamatus squamatus</i> Vigors . . . . .	223
J. Wierzbicka: <i>Paramyxoproteus reinhardti</i> gen. n. et sp. n. ( <i>Bivalvulida</i> , <i>Myxospora</i> ), a Parasite of <i>Reinhardtius hippoglossoides</i> (Walbaum, 1792) . . . . .	227
N. K. Sarkar: On Two New Species of <i>Myxobolus</i> Butschli, 1882 ( <i>Myxozoa</i> : <i>Myxosporae</i> ) from the Fresh Water Fishes of West Bengal, India . . . . .	235

Państwowe Wydawnictwo Naukowe — Oddział we Wrocławiu

Wrocławska Drukarnia Naukowa

Indeks 351334