

## On the formation of horseshoe vortices in plate fin heat exchangers

U. BOSSEL (GÖTTINGEN) and F. V. HONNOLD (SYRACUSE)

By injecting thin dye streaks into the laminar water flow approaching a model of a plate fin heat exchanger, we have studied the flow pattern near the obstacle for low Reynolds numbers. The results of the study illustrate that horseshoe and separation vortices may form in pairs on the vertical approach plane of symmetry. In addition, free stagnation points have been found within the flow field. Based on observations, but augmented by topological reasoning, we construct the flow pattern of three pairs of vortex systems. The evidence may stimulate future analytic work on this subject.

Апроксимируя через встрижние васькй забарвоней смуги в ламинарны пржепылу воды модел плитового wymiennика ciepła, збадано зявнско пржепылу в поблизу прещкody для малых числ Рейнольдса. Wynики тых бадань показую, же вкры подковнсте і oddzielone могу tworzyć ся парамн пры зблнзанн сн до пнонвей пласчынн symetrii. Wewnatrz pola пржепылу зналено ponadto punkty swobodnej stagnacji. Bazую на obserwacjach wspartych rozumowaniem topologicznym, skonstruowano пржепылу trzech пар уклядów wировых. Stanowi to punkt wyjścia do dalszych бадань аналнчных в тым прдмнне.

Аппроксимируя модель плиточного теплообменника, путем впрыскивания узкой окрашенной струйки в ламинарное течение воды, исследовано явление течения вблизи препятствия для малых чисел Рейнольдса. Результаты этих исследований показывают, что подковообразные вихри могут образоваться парами при сближении к вертикальной плоскости симметрии. Внутри поля течения найдены кроме этого свободные критические точки. Базируя на наблюдениях, вспомогательных топологическим рассуждением, построены течения трех пар вихревых систем. Это составляет исходную точку для дальнейших аналитических исследований в этом предмете.

### 1. Introduction

THE evidence presented herewith was recorded during an experimental water tunnel study at Carrier Corporation in partial fulfillment of the Master's Degree requirements of Syracuse University. HONNOLD, Jr. [1] obtained his M. S. degree in February 1970. The work was supervised by the first author. Unfortunately, the interesting observations have not yet been forwarded to a larger community of scientists.

Since then a number of studies have been completed which confirm our finding as well as correct some of our initial interpretation of the delicate flow pattern near the frontispiece of a circular cylinder spaced between two parallel walls of a channel of finite length. In particular, NORMAN [2] has shown by a careful wind tunnel investigation that similar flow patterns may be expected for subsonic gas flows in the regime of boundary-layer transition from laminar to turbulent. Even in the supersonic case horseshoe and separation vortices have been reported by VOITENKO et al. [3, 4] who even observed supersonic zones within the separated flow field. Later, SEDNEY and KITCHENS, Jr. [5] presented a most complete study of the problem for supersonic flows and for boundary layers ranging from laminar to turbulent. Other references on the subject are listed below [6, 7, 8, 9, 10].

There are only a few analytical papers dealing with the flow separation ahead of obstacles. PEAKE and GALWAY [11] attempt a prediction of the shape of the separation envelope, but cannot describe any details within the separated flow region, such as horseshoe or separation vortices. Most recently, topology has lent itself to the qualitative description of intricate flow patterns. PERRY and FAIRLIE [12] have undertaken the task of putting mathematical terms into the vocabulary of a fluid flow specialist. HUNT [13] has skillfully applied topology to interpret his observations of secondary flows near surface protrusions of various geometries.

All evidence known so far seems to support the conclusion that the formation of vortices ahead of surface excrescences is an inviscid flow phenomena and not necessarily a boundary layer effect. Of course, shear flow is required for the formation of horseshoe and separation vortices, but the details of the approaching flow field appear to play an insignificant role. Comparable vortex patterns have been observed in low Reynolds number water flows where the velocity of the incoming stream never exceeded a few centimeters per second (this study). They have also been observed for high Reynolds number air flows at Mach numbers of 3.5 [5] or 21 [9] where even bow shocks have not been able to significantly modify the vortex patterns ahead of surface obstacles. It seems that this area of fundamental fluid mechanics still needs further experimental and analytical attention.

## 2. Experiments

The observations were carried out in a low turbulence water tunnel modified to meet the requirements of our experiments, Fig. 1. In particular, flow straighteners were placed upstream and downstream of the test section and fine mesh screens were installed to estab-

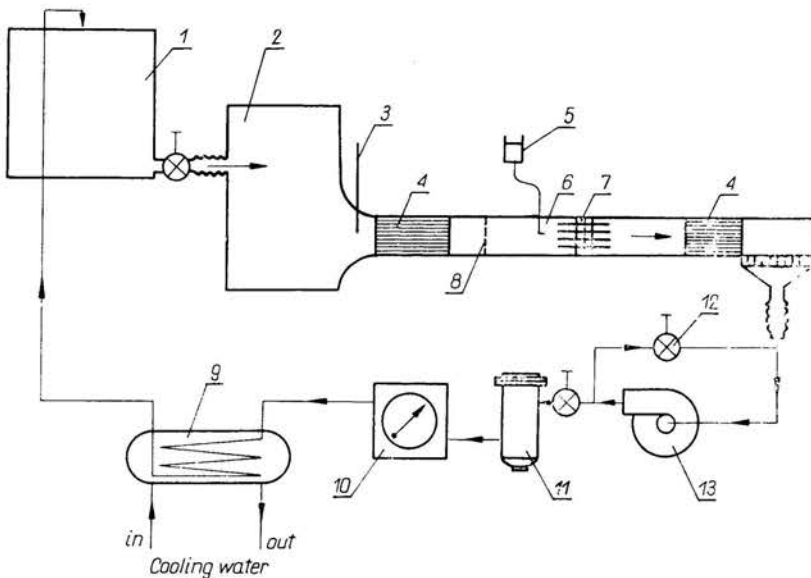

FIG. 1. Experimental set-up.

lish laminar flow conditions. In fact, when the model was removed from the test area, a dye streak (Methylene Blue, A-766, Fisher Scientific Co.) would maintain a straight trajectory from the injection point to the downstream honeycombs even at the highest flow velocities of 4.5 cm/s set by the experimental arrangement. To avoid an upstream penetration of mechanical disturbances into the stagnation region, the water was fed into the entry tank by means of a free return.

The model dimensions are given in Fig. 2. The flow was investigated in the vicinity of a cylinder of  $D = 7.04$  cm diameter. Two half cylinders on either side of the tunnel established the desired symmetry in the passage between the obstacles. The horizontal fins were spaced  $f_s = 1.23$  cm apart. Again, by observing the flow near the center of the channel, any wall effects have virtually been eliminated.

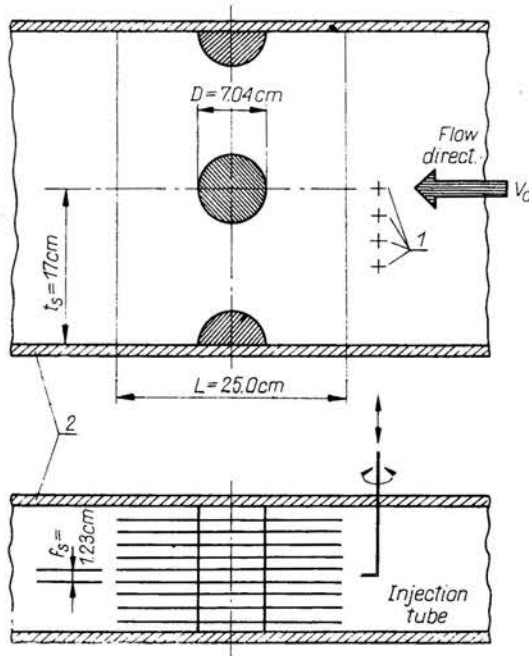

FIG. 2. Model geometries.

Dye was injected into the flow from up to four locations upstream of the model arrangement. The injection tubes of 0.51 mm outer diameter were bent through 90 degrees near the discharge end, so that any desired location within the investigated flow field could be reached by rotating, lowering or raising the dye injectors. The dye streak was typically about 0.25 mm in diameter. In contrast to studies on surface excrescences, the flow field does not extend to infinity in the upward ( $y$ ) direction, but is bound by a plane of symmetry in midspace between two adjacent fins. Thus, no question can arise about the location of the flow attachment point on the front of the cylinder. It must be located at cylinder half height.

This symmetrical arrangement limits the flow field of interest to one half of a fin duct, or roughly, to a fluid layer of only 6 mm thickness. Because of the finite extent of the

dye filament itself, it was difficult to resolve all vortex patterns evidence of which was reproducibly confirmed. Also, because of an undesired growth of the dye streak diameter, observed patterns sometimes blurred before a photographic recording was possible. As customary in heat exchanger studies, the Reynolds number is defined as  $Re = 2f_s U/\nu$ , where  $U$  is the free stream velocity and  $\nu$  the kinematic viscosity. The geometric reference length of twice the fin spacing is the limiting value of the hydraulic diameter of the channel between two fins whose width is allowed to become infinite. One could certainly argue about this choice, but conversions to other reference lengths are easy: to base  $Re$  on the fin spacing, divide our numbers by 2, to base it on the cylinder diameter, multiply our numbers by 2.86, etc. For the low Reynolds numbers investigated in this study, the boundary layer near fin surfaces, or the velocity profile in the channel between two fins was not always fully developed.

### 3. Observations

The flow patterns around the cylinder were observed from the top and the side of the test arrangement. Since a representative set of pictures is contained in ref. [1], we would like to present only sideview photographs showing the formation of vortex systems in the vertical plane of symmetry. The cylinder on the left is approached by fluid from the right.

For the lowest obtainable Reynolds number,  $Re = 160$ , three streamlines are visualized in Fig. 3. No horseshoe vortex has been seen in this reverse flow situation, although the existence of one in the focus of streamline curvature cannot be excluded because of the limited resolution of our experiment. Also, the separation vortex  $SV_1$  near the corner formed by cylinder and plate was not seen directly, but was inferred from the behaviour of streamlines in the vicinity of the fin-cylinder intersection contour.

At Reynolds numbers near 350 the first signs of a horseshoe vortex  $HV_1$  became traceable by our dye technique. The hump near the fin plate shown in Fig. 4 indicates that separation of the reverse flow has occurred and that, consequently, a separation vortex  $SV_2$  has been formed. Note that fluid originating from the vicinity of the horizontal

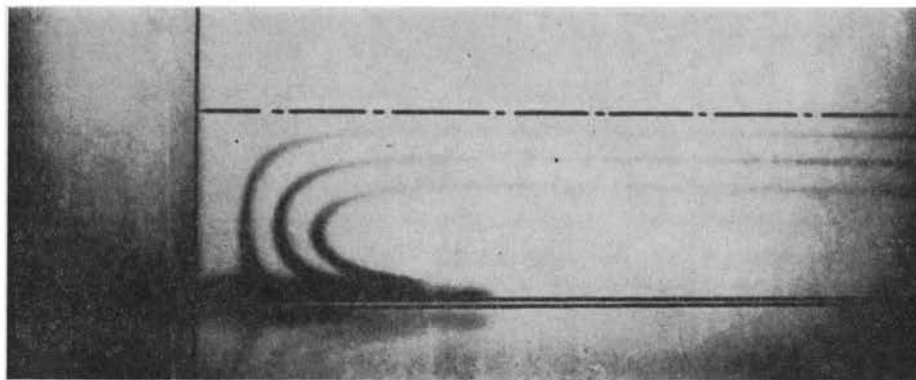

FIG. 3. Reverse flow at  $Re = 160$ .

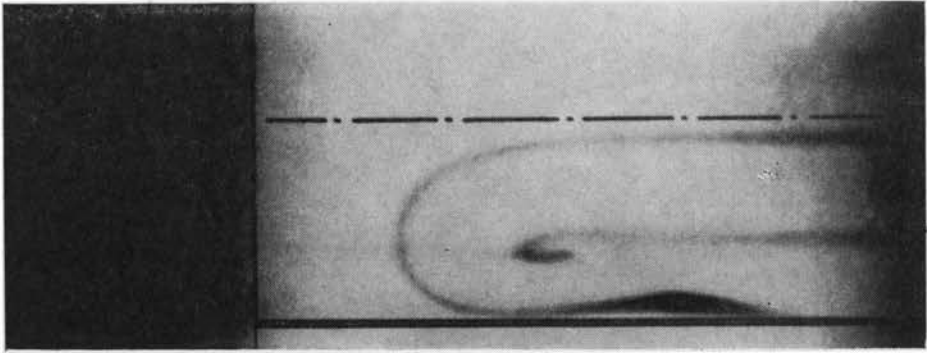

FIG. 4. Flow at  $Re = 350$ . Formation of the first horseshoe vortex.

plane of symmetry is drawn into the reverse flow separation, whereas fluid from less energetic layers curls up into the horseshoe vortex  $HV_1$ .

The sequence of photographs shown in Fig. 5 documents the intricacy of the flow pattern at  $Re = 1100$ . By lowering the dye streak from near the channel center (a) to the lower fifth of the passage (g) the formation of a reverse flow separation vortex  $SV_2$  underneath the cusp (a, b, c), of a free stagnation point and the first horseshoe vortex  $HV_1$  (d, e, t), and of the second horseshoe vortex  $HV_2$  (g) has been followed. The streamlines (d) and (f) meet within the flow to form a free stagnation point. The forward branch of the two streamlines leaving this isolated saddle point which [12] was termed an "inviscid-constant-vorticity critical point" curves into the horseshoe vortex  $HV_1$ . The rearward branch continues to flow upstream and is, most likely, drawn into the frontal separation envelope. Fluid contained between streamlines (d) and (f) is drawn into the vortex  $HV_1$ , whereas fluid below (f) may form additional horseshoe systems, as shown in (g).

By simultaneous release of two dye streaks on streamlines (d) and (f) a flow structure is visualized in Fig. 6 which could have been constructed by superimposing the patterns of the two streamline arrangements discussed above. To our knowledge, the formation of free stagnation points has never before been documented for horseshoe vortex systems.

#### 4. Conclusions

Finally, we use the presented and unpublished evidence, results of other investigators and topological reasoning to construct the flow field of a three-pair vortex system shown in Fig. 7. We feel that such a complex streamline pattern is characterized by 4 points of flow attachment, 4 points of flow separation, 3 horseshoe vortices, 3 separation vortices, and 2 free stagnation points.

According to the rules discussed in [13] the attachment and separation points must be weighted by a factor of one half for reasons of symmetry, so that a total of four nodes is counted.

a

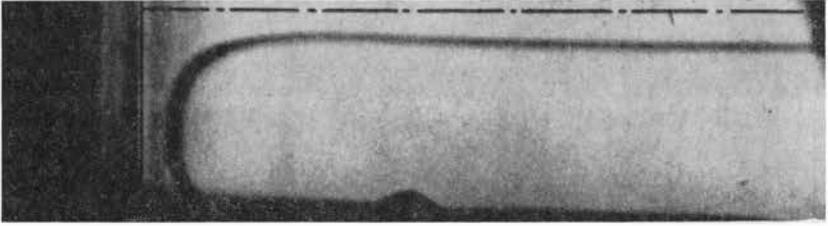

b

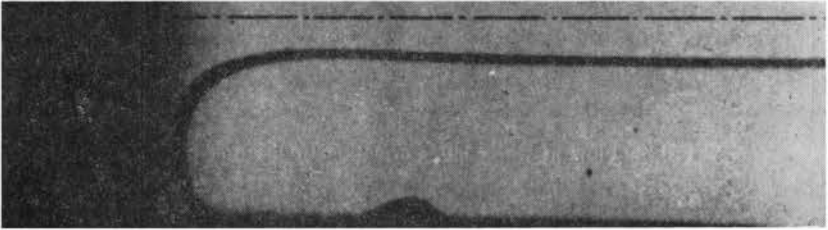

c

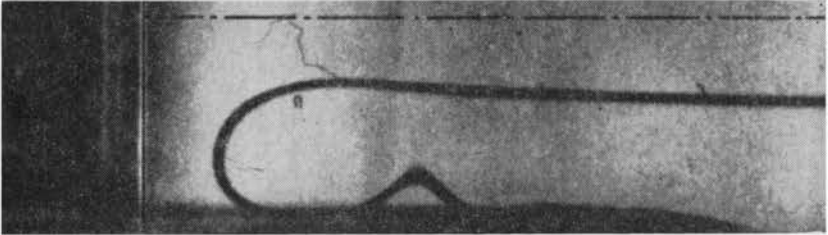

d

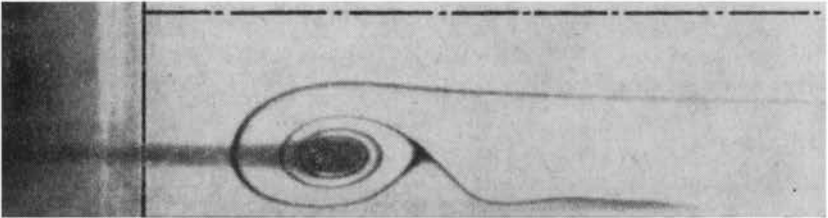

e

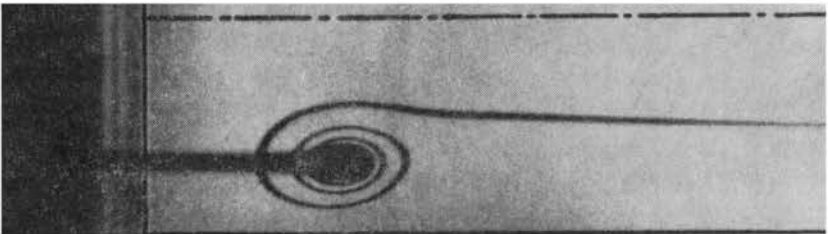

f

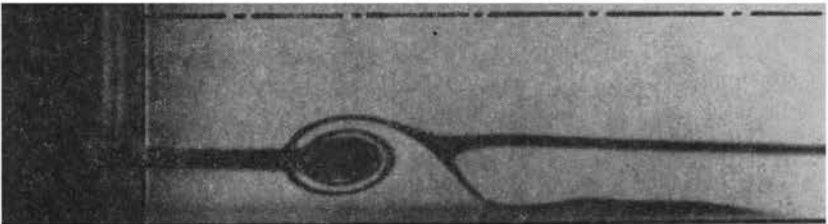

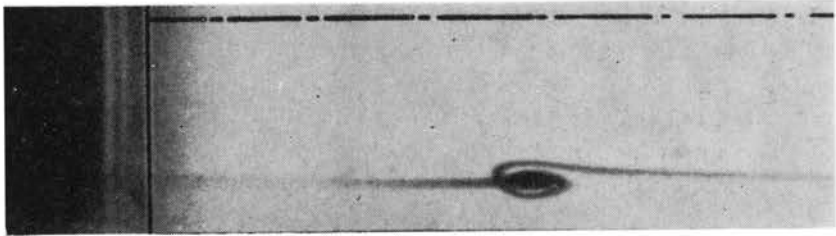

FIG. 5. Streamline traces for  $Re = 1100$  showing the formation of two horseshoe vortices, a free stagnation point and reverse flow separation.

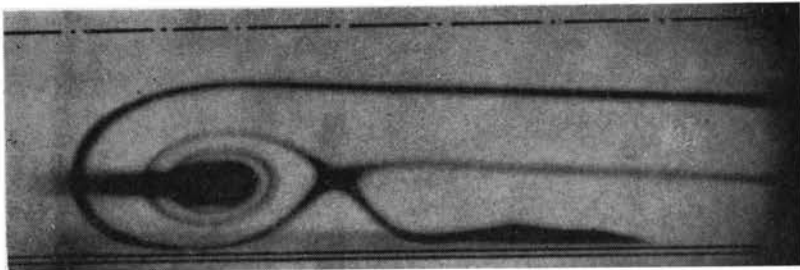
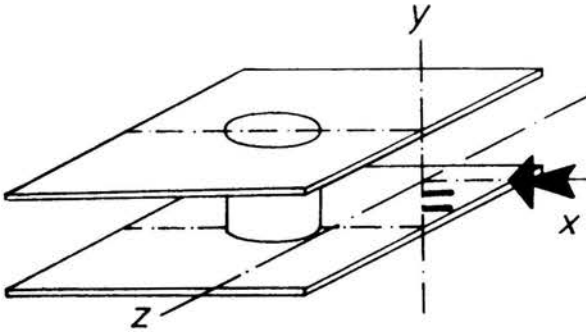

FIG. 6. Formation of a free stagnation point between two horseshoe vortices.

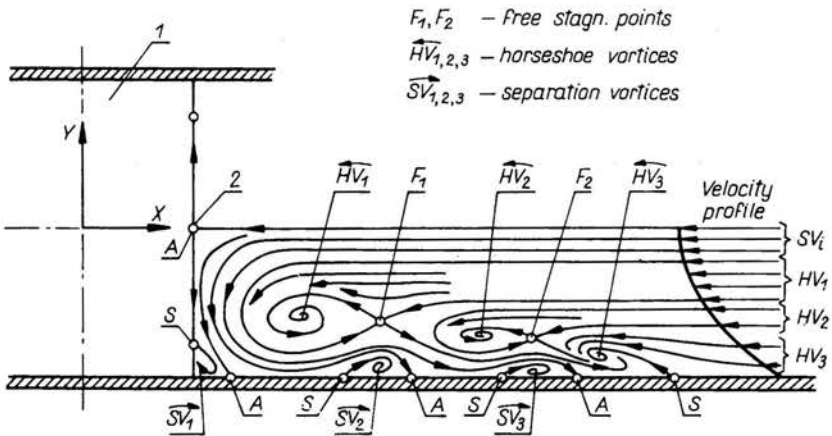

FIG. Sketch of flow pattern for three horseshoe vortices.



It can easily be seen, that a two-pair or a one-pair system can be obtained by subtracting 1 or 2 from above numbers, respectively. We thus like to suggest a generalized formula for an  $n$ -paired vortex system for which  $n+1$  nodal (attachment and separation) points, but only  $(n-1)$  saddle (free stagnation) points should be expected. This result agrees with Lighthill's [14] accounting procedure, i.e. the total number of nodes minus the total number of saddles should be equal to two. In reverse, Lighthill's results also seem to confirm the conclusions drawn from our observations. Also, it seems worthy to remark that, according to our evidence, fluid originally contained in the region near the horizontal plane of symmetry will eventually be drawn into separation vortex systems. In contrast, the less energetic portion of the incoming flow, i.e. the fluid layers already containing vorticity, will form the systems of horseshoe vortices.

## References

1. F. V. HONNOLD JR., *Determination of the flow through-out a single row plate fin heat exchanger at low Reynolds numbers*, Master's Thesis, Syracuse University, New York, USA, February 1970.
2. R. S. NORMAN, *On obstacle generated secondary flows in laminar boundary layers and transition to turbulence*, Ph. D. Thesis, Chicago, Ill., December 1972.
3. D. M. VOITENKO, A. I. ZUBKOV, YU. A. PANOV, *Supersonic gas flow past a circular obstacle on a plate*, *Mekhanika Zhidkosti i Gaza*, **1**, 1, 121-125, 1966.
4. D. M. VOITENKO, A. I. ZUBKOV, YU. A. PANOV, *Existence of supersonic zones in three-dimensional separation flows*, *Mekhanika Zhidkosti i Gaza*, **2**, 1, 20-24, 1967.
5. R. SEDNEY, C. W. KITCHENS JR., *The structure of three-dimensional separated flows in obstacle-boundary layer interaction*, AGARD Conference on Flow Separation, Göttingen, FRG, May 1975.
6. N. GREGORY, W. S. WALKER, *The effect on transition of isolated surface excrescences in the boundary layer*, Aeronautical Research Council, Reports and Memoranda, No. 2779, Oct. 1950.
7. J. C. WESTKAEMPER, *Turbulent boundary-layer separation ahead of cylinders*, *AIAA Journal*, **6**, 7, 1968.
8. R. SEDNEY, *A survey of the effects of small perturbances on boundary-layers flows*, *AIAA J.*, **11**, 6, June 1973.
9. L. G. KAUFMAN II, *Shock impingement caused by boundary-layer separation ahead of blunt fins*, *AIAA J.*, **11**, 10, Oct. 1973.
10. E. C. MASKELL, *Flow separation in three dimensions*, RAE Farnborough, Report No. Aero 2565, November 1955.
11. D. J. PEAKE, R. D. GALWAY, *The three-dimensional separation of a plane incompressible laminar boundary layer produced by a circular cylinder mounted normal to flat plate*, AGARDograph 97, Recent Developments in Boundary-Layer Research, May 1965.
12. A. E. PERRY, B. D. FAIRLIE, *Critical points in flow patterns*, *Adv. Geophys.*, **18** B, 1974.
13. J. HUNT, *Notes on visualising the mean flow field around a three-dimensional surface obstacle in a turbulent flow*, Department of Applied Mathematics and Theoretical Physics, University of Cambridge, Cambridge-England.
14. M. J. LIGHTHILL, In: *Laminar boundary layers*, L. Rosenhead, Ed., Oxford University Press, 1963.

DFVLR-AVA, GÖTTINGEN, F.R.G.

and

CARRIER CORP., SYRACUSE, N.Y., USA.

Received September 16, 1975.